



Compact circuit-breaker NZM up to 1600 A Compact switch-disconnectors N, PN up to 1600 A

Safe energy control, switching and control in industrial settings, buildings and machinery construction: innovative protection concept coupled with diagnostic and communication functions make it possible.

The NZM circuit-breaker assortment offers an interface for the SmartWire-Darwin communication system. → Page 17/140



Model series NZM1 – NZM4

Only four compact switches cover all applications +++ 3- and 4-pole +++ Flexible mounting through modular functions groups +++ Complete nominal current up to 50 °C ambient temperature +++ Suitable for use worldwide → Page 17/4

Door coupling rotary handles

Very wide range of variants for each application +++ All applications have identical drilling template +++ Automatic centering +++ Shaft support for years of operational safety +++ Sidewall installation for space-saving main switch installation → Page 17/118

Standard auxiliary contacts, trip-indicator auxiliary contacts from the Eaton command device program.

Favorably priced identical parts from the Titan program reduce variety of types and stockkeeping +++ Installation from front to same position +++ Easy clip-in reduces assembling costs → Page 17/106

Remote operators

Unified functions concept for all variants +++ Small closing delays from 60 – 100 ms +++ Can be locked and sealed to provide safety → Page 17/134

Diagnostics software NZM-XPC-SOFT

Diagnostics in fault scenario +++ Error-free commissioning +++ Load analysis in operation → Page 17/138



Eaton After Sales Service

Testing switching devices in compliance with regulations applicable to this technology → S22/2

Compact circuit-breakers and switch-disconnectors up to 1600 A

System overview

Circuit-breakers, switch-disconnectors 3/4 pole	17/4
---	------

Technical overview

Circuit-breakers, switch-disconnectors 3/4 pole	17/6
---	------

Ordering

Circuit-breakers, thermomagnetic releases 3 pole	17/8 3
Circuit-breakers, magnetic short-circuit releases, 3 pole	17/18
Circuit-breakers, electronic releases, 3 pole	17/22
Circuit-breakers, thermomagnetic releases, 4 pole	17/28
Circuit-breakers, electronic releases, 4 pole	17/36
Switch-disconnectors, 3 pole	17/42
Switch-disconnectors, 4 pole	17/44
Circuit-breakers for 1000 V AC, 3 pole	17/46
Switch-disconnectors for 1000 V DC, 2 pole	17/49
Switch-disconnectors in ATEX type	17/50

Technical overview

Circuit-breakers, switch-disconnectors for North America, 3/4 pole	17/52
--	-------

Ordering

Circuit-breakers UL/CSA, IEC, thermomagnetic releases, 3 pole	17/54
Circuit-breakers UL/CSA, IEC, magnetic short-circuit releases, 3 pole	17/72
Circuit-breakers UL/CSA, IEC, electronic releases, 3 pole	17/64
Circuit-breakers UL/CSA, IEC, thermomagnetic releases, 4 pole	17/78
Molded case switches for North America	17/80

Ordering

Terminals	17/82
Plug-in units, withdrawable units	17/105
Auxiliary contacts	17/106
Undervoltage releases	17/108
Shunt releases	17/114
Door coupling rotary handles	17/118
Door coupling rotary handles for North America	17/120
Rotary handles with door interlock	17/123
Main switch assembly kit	17/124
Accessories	17/127
Mechanical interlock	17/130
Paralleling mechanism	17/131
Multifunction component adapter	17/122
Remote drive	17/134
Earth-fault release	17/135
Earth-fault release, residual-current relay	17/137
Diagnostics, energy metering, communication	17/138
SmartWire-DT communication module	17/140
Insulated enclosures	17/142

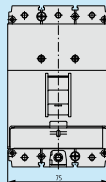
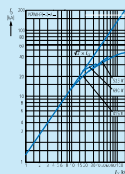

Engineering

Selectivity: incoming circuit-breaker, outgoing circuit-breaker	17/144
Cable protection, back-up protection	17/148
Direction of blow-out, minimum clearances, tube cable lugs	17/149
Auxiliary contacts, trip-indicating auxiliary contacts	17/150
Mechanical interlock for (door-coupling) rotary handles	17/151
Mechanical interlock for remote operator, residual-current relay	17/152
Remote operator, main switch assembly kit, terminals	17/153
Tripping characteristic	17/154
Let-through characteristics	17/158
Residual-current release of the frequency response	17/164

Technical data

Circuit-breakers, switch-disconnectors	17/165
Circuit breakers	17/166
Circuit-breakers, switch-disconnectors for 1000 V	17/168
Switch-disconnectors	17/169
Moulded case switches	17/170
Current limiting values, weights	17/171
Temperature dependency, thermomagnetic release	17/172
Temperature dependency, electronic release	17/173
Active power loss	17/174
Terminal capacities	17/176
Switch-disconnectors for 1000 V, bridge kits: temperature dependency	17/178
Auxiliary contacts, equipping time differences	17/179
Undervoltage release, shunt release, capacitor unit	17/180
Remote operator, residual-current relay	17/181
Residual-current releases	17/182
Data management interface (DMI module)	17/183
Fieldbus connection	17/184
SmartWire-DT communication module	17/186
Measuring and communication module	17/188

Dimensions

Construction size 1: basic devices	17/189
Construction size 1: accessories	17/190
Construction size 2: basic devices	17/198
Construction size 2: accessories	17/199
Construction size 3: basic devices	17/210
Construction size 3: accessories	17/211
Construction size 4: basic devices	17/220
Construction size 4: accessories	17/221
Measuring and communication module	17/233
SmartWire-DT communication module	17/233





xEnergy is a freely combinable range of system products for energy distribution systems – specially designed for infrastructures in buildings and industrial applications up to 4000 A. The Moeller xEnergy system – consisting of switching and protective devices, the mounting system, the switchboard, as well as the planning and calculation tool – is optimally tailored for safe and reliable energy distribution.

The optimum mechanical adaption of the switchboard components to the Moeller switchgear keeps mounting times short and ensures a high level of flexibility. Type-testing of the complete switchgear–mounting system–switchboard assemblies to IEC EN 60 439 ensures a high level of safety.



Moeller Configurator

Moeller Configurator

The software tool offers you the support you need for configuring the required xEnergy switchgear assembly simply and quickly. You can thus create your quotations and generate the exact parts list at the click of a mouse.



xEnergy Product features

- Enclosures for combination- and separate mounting
- Protection type IP 31 or 55
- Main busbars up to 4000 A
- 2 main busbar systems can be integrated in each section
- Clear separation into functional areas to Form 1 up to Form 4b for increased personal and system protection
- Widths 425, 600, 800, 1000 und 1200 mm
- Height 2000 mm
- Color RAL 7035 (others possible)
- Mains system types TN-C, TN-C-S, TN-S, TT, IT
- Type-tested switchgear assembly (TSK) according to IEC/EN 60439-1
- Optimized for 3 and 4 pole switchgear from Moeller



IZM and NZM circuit-breakers for xEnergy XPower sections

- Clear and symmetrical design reduces the number of busbar connections and saves mounting time
- Simple installation with cable terminal system for drill-free connection in section width

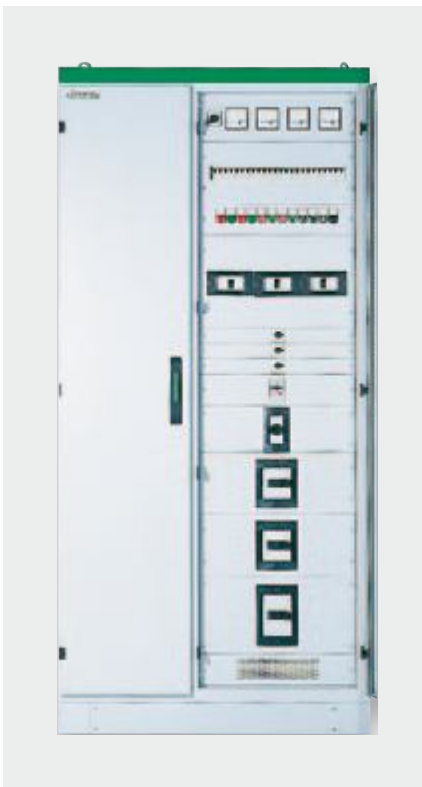

NZM and PKZ circuit-breakers for xEnergy XFixed sections

- High packing density with up to 38 modules in one section thus optimum component utilization
- Flexible module mounting to Form 4 with individual swing front panels
- Simple module mounting to Form 2 on one mounting level
- Flexible combination of functional areas and busbars to IEC/EN 60439 and national installation practices



Prefabricated energy and control distributions

Our system partner operate prefabricated energy and control distributions worldwide.

www.moeller-systempartner-schaltanlagen.net



NZM

System overview

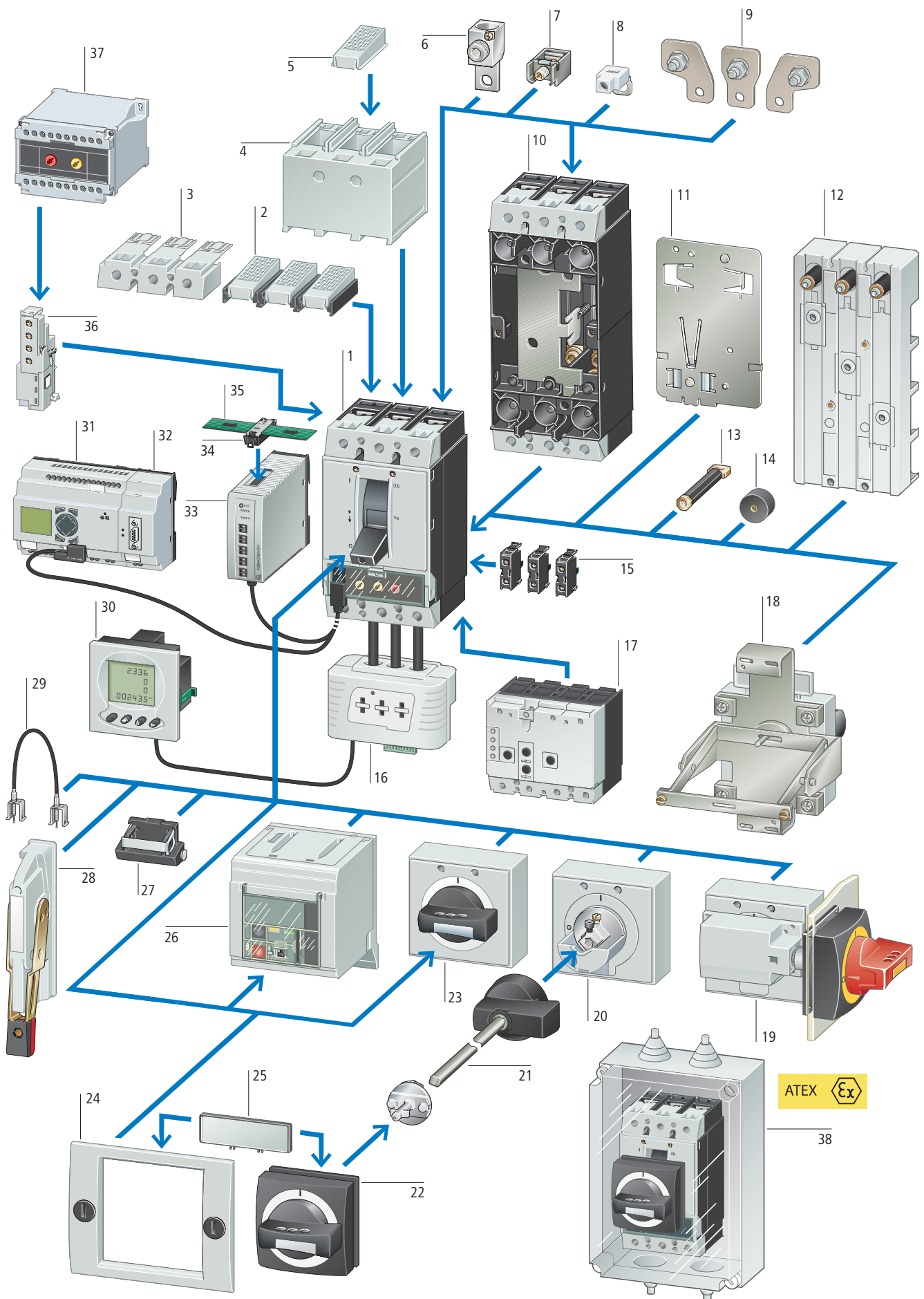

NZM

Basic devices		Measuring and communication module	16	Terminal covers	4
Circuit-breakers	1	For reading current, voltage, power and energy MODBUS interface on board → Page 17/141		Protection against direct contact where cable lugs, bars or tunnel terminals are used NZM1 → Page 17/84 NZM2 → Page 17/88 NZM3 → Page 17/98 NZM4 → Page 17/104	
Rated uninterrupted current up to 1600 A Switching capacity 25, 36, 50, 150 kA at 415 V Adjustable releases for overload and short-circuit Adjustable time selectivity Protection of systems, cables, motors, generators 3 and 4 pole; IEC/EN 60947 → Page 17/8		Display	30	Terminal covers, knockout	3
Switch-disconnectors	1	Connectable to modules NZM...XMC-MB With templates for viewing XMC readings Indication of min. and max. values → Page 17/141		NZM1 → Page 17/84 NZM2 → Page 17/88 NZM3 → Page 17/98 NZM4 → Page 17/104	
Rated uninterrupted current up to 1600 A Can be tripped remotely with undervoltage or shunt release 3 and 4 pole; IEC/EN 60947 → Page 17/42		Data management interface (DMI module)	31	Clips	11
Circuit-breakers for North America	1	Access to diagnostics and operational data Acquisition of current values Motor starter function Parameterization and control of circuit-breakers with electronic releases → Page 17/139		NZM1-XC35 for 35-mm-top-hat rail NZM2-XC75 for 75-mm-top-hat rail → Page 17/129	
Rated uninterrupted current up to 1200 A Switching capacity 25, 35, 100 kA at 480 V Adjustable release for overload and short-circuit Adjustable time selectivity Protection of systems, cables, motors, generators 3 and 4 pole, UL 489/CSA 22.2 no. 5.1, IEC/EN 60947 → Page 17/54		PROFIBUS-DP interface	32	Busbar adapters	12
Molded case switches for North America	1	→ Page 17/139		→ Page 17/132	
Rated uninterrupted current up to 1200 A Can be tripped remotely with undervoltage or shunt release 3 pole, UL489/CSA 22.2 no. 5.1 → Page 17/80		Mounting accessories		Rear connection terminals	13
Add-on functions		Connection width extensions	9	NZM1 → Page 17/82 NZM2 → Page 17/86 NZM3 → Page 17/94 NZM4 → Page 17/102	
Standard auxiliary contacts (HIV)	15	NZM3 → Page 17/92 NZM4 → Page 17/103		Plug-in units and withdrawable units	10
Switches with the main contacts. Performs signalling and interlock functions → Page 17/106		Control cable terminals	8	→ Page 17/105	
Trip-indicating auxiliary contacts (HIA)	15	For two terminal locations at top or bottom NZM1 → Page 17/84 NZM2 → Page 17/88 NZM3 → Page 17/84 NZM4 → Page 17/104		Insulating surround	24
General trip indication '+', when tripped by voltage release, overload release or short-circuit release → Page 17/106		Tunnel terminals for Al and copper cables	6	For toggle levers, rotary mechanisms and remote operators → Page 17/129	
Early-make auxiliary contacts	36	Standard with control circuit terminal NZM1 → Page 17/82 NZM2 → Page 17/86 NZM3 → Page 17/94 NZM4 → Page 17/102		External warning plate/designation labels	25
For interlock and load-shedding circuits → Page 17/106		Box terminals	7	→ Page 17/54	
Voltage releases	15	Standard equipment on construction size 1 Flush mounting within the switch housing NZM1 → Page 17/82 NZM2 → Page 17/86 NZM3 → Page 17/92		Spacers	14
Undervoltage releases Shunt releases → Page 17/108		IP2X protection against contact with finger	2	→ Page 17/129	
Insulated enclosures	38	For box terminals NZM1 → Page 17/84 NZM2 → Page 17/88 NZM3 → Page 17/98 NZM4 → Page 17/98		IP2X protection against contact with finger	5
Safety switches (maintenance and manual override switches) approved for use in potentially explosive areas in Zone 22. Degree of protection IP66 ATEX  → Page 17/142		IP2X protection against contact with finger	2	For covers NZM1 → Page 17/84 NZM2 → Page 17/88 NZM3 → Page 17/98	
Delay unit for undervoltage releases	37				
→ Page 17/114					
Rear-mounted drives	18				
→ Page 17/127					
Door coupling rotary handles	20				
• Lockable • With door interlock → Page 17/118	22				
Main switch rotary handles for side wall installation	19				
→ Page 17/125					
Extension shaft	21				
Can be cut to required length → Page 17/118					
Rotary handles	23				
Lockable → Page 17/122					
Remote operators	26				
For remote switching of circuit-breakers and switch-disconnectors → Page 17/134					
Residual-current protection device	17				
→ Page 17/135					
Toggle lever locking device	27				
→ Page 17/129					
Side operator handle	28				
→ Page 17/128					
Mechanical interlocks	29				
→ Page 17/130					
Communication module NZM for SmartWire-Darwin	33				
For reading status data, current values, switch model and set values → Page 17/140					



Circuit-breakers

With main switch characteristics to IEC/EN 60204 and Isolator characteristics to IEC/EN 60947, VDE 0660

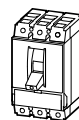

Rated uninterrupted current I_u =
Rated current I_n
Adjustable overload releases I_r
Adjustable short-circuit releases I_i
Delayed short-circuit releases I_{sd}

Thermomagnetic releases**System and cable protection****Motor protection**

I_u	I_u	I_o	I_r	I_i	I_u	I_u	I_r	I_i
A	A	A	A	A	A	A	A	A

Ambient temperature at 100% I_u min./max. -25/+50 °C	20	20			0.8 – 1 × I_n	350		20		0.8 – 1 × I_n	350
	25	25						25			
	32	32						32			10 – 14 × I_n
	40	40				8 – 10 × I_n	40	40			8 – 14 × I_n
	50	50				6 – 10 × I_n	50	50			
	63	63					63	63			
	80	80					80	80			
	100	100					100	100			NZM1: 8 – 12.5 × I_n NZM2: 8 – 14 × I_n
	125	125						125			8 – 14 × I_n
	160	160				NZM1: 8 × I_n 6 – 10 × I_n		160			
		200						200			
		250									
								320			
								400			
								500			

Basic switching capacity		NZMB1-A...	NZMB2-A...					NZMB1-M...	NZMB2-M...		
400/415 V	kA/p.f	25	0.25	25	0.25			25	0.25	25	0.25
440 V	kA/p.f	25	0.25	25	0.25			25	0.25	25	0.25
Comfort switching capacity		NZMC1-A...	NZMC2-A...	NZMC3-A...							
400/415 V	kA/p.f	36	0.25	36	0.25	36	0.25				
440 V	kA/p.f	30	0.25	30	0.25	30	0.25				
525 V	kA/p.f	12	0.5	12	0.5	12	0.5				
690 V	kA/p.f	8	0.5	8	0.5	8	0.5				
Normal switching capacity		NZMN1-A...	NZMN2-A...	NZMN3-A...				NZMN1-M...	NZMN2-M...		
400/415 V	kA/p.f	50	0.25	50	0.25	50	0.25	50	0.25	50	0.25
440 V	kA/p.f	35	0.25	35	0.25	35	0.25	35	0.25	35	0.25
525 V	kA/p.f	20	0.30	25	0.25	25	0.25	20	0.30	25	0.25
690 V	kA/p.f	10	0.50	20	0.30	20	0.30	10	0.50	20	0.30
High switching capacity		NZMH1-A...	NZMH2-A...	NZMH3-A...					NZMH2-M...		
400/415 V	kA/p.f	100	0.20	150	0.20	150	0.20			150	0.20
440 V	kA/p.f	35	0.25	130	0.20	130	0.20			130	0.20
525 V	kA/p.f	20	0.30	50	0.25	65	0.20			50	0.25
690 V	kA/p.f	10	0.50	20	0.30	35	0.25			20	0.30

Notes

The stated switching capacity values are rated ultimate short-circuit breaking capacities (I_{cu})

Switch-disconnectors

With main switch characteristics to IEC/EN 60204 and VDE 0113
Isolating characteristics to IEC/EN 60947, VDE 0660
without overload and short-circuit release

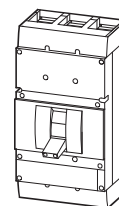
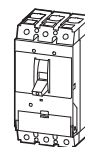
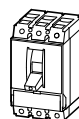

Rated uninterrupted current I_u =
Rated current I_n

		63 – 160	160 – 250	400 – 630	630 – 1600			
Type N can be triggered with U/A shunt release		PN1-...	N1-...	PN2-...	N2-...	PN3-...	N3-...	N4-...
Rated short-circuit making capacity I_{cm}	kA	2.8	2.8	5.5	5.5	25	25	53
Rated short-time withstand current I_{cw} (1s-current _{rms})	kA	2	2	3.5	3.5	12	12	25

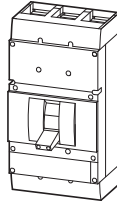
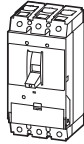
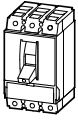

Electronic releases

Systems, cable, selectivity and generator protection

Motor protection





I_u	I_u	I_u	I_r	I_{sd}	I_i	I_u	I_r	I_i
A	A	A	A	A	A	A	A	A
100	250		0.5 – 1 × I_n	2 – 10 × I_r	2 – 12 × I_n	90	0.5 – 1 × I_n	2 – 14 × I_r
160	400					140		
250	630	630				220		
		800				350		
		1000				450		
		1250		2 – 6 × I_r	2 – 8 × I_r	550		
		1600				875		
						1400		

NZMN2-...E...		NZMN3-...E...		NZMN4-...E...		NZMN2-ME...		NZMN3-ME...		NZMN4-ME...	
50	0.25	50	0.25	50	0.25	50	0.25	50	0.25	50	0.25
35	0.25	35	0.25	35	0.25	35	0.25	35	0.25	35	0.25
25	0.25	25	0.25	25	0.25	25	0.25	25	0.25	25	0.25
20	0.30	20	0.30	20	0.30	20	0.30	20	0.30	20	0.30
NZMH2-...E...		NZMH3-...E...		NZMH4-...E...		NZMH2-ME...		NZMH3-ME...		NZMH4-ME...	
150	0.20	150	0.20	85 ¹⁾	0.20	150	0.20	150	0.20	85 ¹⁾	0.20
130	0.20	130	0.20	85	0.20	130	0.20	130	0.20	85	0.20
50	0.25	65	0.20	65	0.20	50	0.25	65	0.20	65	0.20
20	0.30	35	0.30	50	0.25	20	0.30	35	0.30	50	0.25

A selection of approved circuit-breakers and switch-disconnectors for world-wide use → Page 17/54
 1) For higher switching capacity please inquire



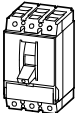



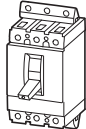
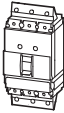

Ordering

	Switching capacity 400/415 V 50/60 Hz	Rated current = Rated uninterrupted current	Setting range		Fixed mounting with screw terminals	Part no. Article no.	Price See price list
			Overload releases	Short-circuit releases			
			I_r A	Non-delayed $I_i = I_n \times \dots$			
	I_{cu} kA	$I_n = I_u$ A					
System and cable protection							
Basic switching capacity							
	25	20	15-20	350 A fixed	Screw terminals as accessories		
		25	20-25	350 A fixed			
		32	25-32	350 A fixed			
		40	32-40	8-10			
		50	40-50	6-10			
		63	50-63	6-10			
		80	63-80	6-10			
		100	80-100	6-10			
		125	100-125	6-10			
		160	125-160	1280 A fixed			
		160	125-160	6-10		NZMB2-A160 259088	S
		200	160-200	6-10		NZMB2-A200 259089	S
		250	200-250	6-10		NZMB2-A250 259090	S
		300	240-300	6-10		NZMB2-A300 107518	S
Comfort switching capacity							
	36	20	15-20	350 A fixed	Screw terminals as accessories		
		25	20-25	350 A fixed			
		32	25-32	350 A fixed			
		40	32-40	8-10			
		50	40-50	6-10			
		63	50-63	6-10			
		80	63-80	6-10			
		100	80-100	6-10			
		125	100-125	6-10			
		160	125-160	1280 A fixed			

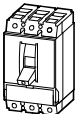

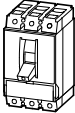
Fixed mounting with box terminals			Plug-in units			
Part no. Article no.	Price See price list		Part no. Article no.	Price See price list	Std. pack	Notes
			Order base separately			
						B = box terminals S = screw terminals For further terminal types see accessories
NZMB1-A20 280987		B		NZMB1-A20-SVE 112733	1 off	IEC/EN 60947-2
NZMB1-A25 280988		B		NZMB1-A25-SVE 112734		
NZMB1-A32 280989		B		NZMB1-A32-SVE 112735		
NZMB1-A40 259075		B		NZMB1-A40-SVE 112703		
NZMB1-A50 259076		B		NZMB1-A50-SVE 112704		
NZMB1-A63 259077		B		NZMB1-A63-SVE 112705		
NZMB1-A80 259078		B		NZMB1-A80-SVE 112706		
NZMB1-A100 259079		B		NZMB1-A100-SVE 112707		
NZMB1-A125 259080		B		NZMB1-A125-SVE 112708		
NZMB1-A160 281230		B		—		
NZMB2-A160-BT 110215		B		NZMB2-A160-SVE 113193		
NZMB2-A200-BT 110216		B		NZMB2-A200-SVE 113194		
NZMB2-A250-BT 110217		B		NZMB2-A250-SVE 113195		
NZMB2-A300-BT 110214		B		—		
NZMC1-A20 283293		B		NZMC1-A20-SVE 112753	1 off	IEC/EN 60947-2
NZMC1-A25 283294		B		NZMC1-A25-SVE 112754		
NZMC1-A32 283295		B		NZMC1-A32-SVE 112755		
NZMC1-A40 271392		B		NZMC1-A40-SVE 112737		
NZMC1-A50 271393		B		NZMC1-A50-SVE 112738		
NZMC1-A63 271394		B		NZMC1-A63-SVE 112739		
NZMC1-A80 271395		B		NZMC1-A80-SVE 112740		
NZMC1-A100 271396		B		NZMC1-A100-SVE 112741		
NZMC1-A125 271397		B		NZMC1-A125-SVE 112742		
NZMC1-A160 283296		B		—		

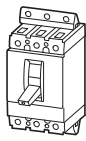
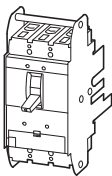
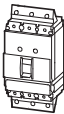

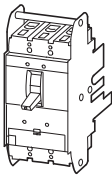
	Switching capacity 400/415 V 50/60 Hz	Rated current = Rated uninterrupted current	Setting range		Fixed mounting with screw terminals	Part no. Article no.	Price See price list			
			Overload releases	Short-circuit releases						
			I_r A	Non-delayed $I_i = I_n \times \dots$						
	I_{cu} kA	$I_n = I_u$ A	I_r A							
										
System and cable protection										
Comfort switching capacity										
	36	160	125-160	6-10	Screw terminals as accessories	NZMC2-A160 271421	S			
		200	160-200	6-10		NZMC2-A200 271422	S			
		250	200-250	6-10		NZMC2-A250 271423	S			
		300	240-300	6-10		NZMC2-A300 107519	S			
		320	250-320	6-10		NZMC3-A320 109665	S			
		400	320-400	6-10		NZMC3-A400 109666	S			
		500	400-500	6-10		NZMC3-A500 109667	S			
Normal switching capacity										
	50	20	15-20	350 A fixed	Screw terminals as accessories					
		25	20-25	350 A fixed						
		32	25-32	350 A fixed						
		40	32-40	8-10						
		50	40-50	6-10						
		63	50-63	6-10						
		80	63-80	6-10						
		100	80-100	6-10						
		125	100-125	6-10						
		160	125-160	1280 A fixed						
			50	160		125-160	6-10	Screw terminals as accessories	NZMN2-A160 259092	S
				200		160-200	6-10		NZMN2-A200 259093	S
				250		200-250	6-10		NZMN2-A250 259094	S
300	240-300			6-10	NZMN2-A300 107580	S				
320	250-320			6-10	NZMN3-A320 109669	S				
400	320-400			6-10	NZMN3-A400 109670	S				
500	400-500			6-10	NZMN3-A500 109671	S				



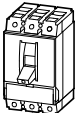

Fixed mounting with box terminals			Plug-in units			
Part no. Article no.	Price See price list		Part no. Article no.	Price See price list	Std. pack	Notes
			Order base separately			
						B = box terminals S = screw terminals For further terminal types see accessories
NZMC2-A160-BT 110219		B		NZMC2-A160-SVE 113220	1 off	IEC/EN 60947-2
NZMC2-A200-BT 110280	B	NZMC2-A200-SVE 113221				
NZMC2-A250-BT 110281	B	NZMC2-A250-SVE 113222				
NZMC2-A300-BT 110218		B				
NZMC3-A320-BT 110299		B		NZMC3-A320-AVE 113509		
NZMC3-A400-BT 110300	B	NZMC3-A400-AVE 113510				
NZMC3-A500-BT 110301	B	NZMC3-A500-AVE 113511				
NZMN1-A20 281231		B		NZMN1-A20-SVE 112776	1 off	IEC/EN 60947-2
NZMN1-A25 281232	B	NZMN1-A25-SVE 112777				
NZMN1-A32 281233	B	NZMN1-A32-SVE 112778				
NZMN1-A40 259081	B	NZMN1-A40-SVE 112757				
NZMN1-A50 259082	B	NZMN1-A50-SVE 112758				
NZMN1-A63 259083	B	NZMN1-A63-SVE 112759				
NZMN1-A80 259084	B	NZMN1-A80-SVE 112760				
NZMN1-A100 259085	B	NZMN1-A100-SVE 112761				
NZMN1-A125 259086	B	NZMN1-A125-SVE 112762				
NZMN1-A160 281234	B					
NZMN2-A160-BT 110283		B				
NZMN2-A200-BT 110284	B	NZMN2-A200-SVE 113245				
NZMN2-A250-BT 110285	B	NZMN2-A250-SVE 113246				
NZMN2-A300-BT 110282		B				
NZMN3-A320-BT 110302		B		NZMN3-A320-AVE 110858		
NZMN3-A400-BT 110303	B	NZMN3-A400-AVE 110859				
NZMN3-A500-BT 110304	B	NZMN3-A500-AVE 110860				

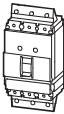
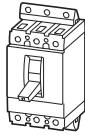
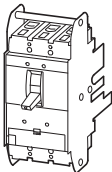







	Switching capacity 400/415 V 50/60 Hz	Rated current = Rated uninterrupted current	Setting range		Fixed mounting with screw terminals	Part no. Article no.	Price See price list
			Overload releases	Short-circuit releases			
			I_r A	Non-delayed $I_i = I_n \times \dots$			
	I_{cu} kA	$I_n = I_u$ A					
System and cable protection							
High switching capacity							
	100	20	15-20	350 A fixed	Screw terminals as accessories		
		25	20-25	350 A fixed			
		32	25-32	350 A fixed			
		40	32-40	8-10			
		50	40-50	6-10			
		63	50-63	6-10			
		80	63-80	6-10			
		100	80-100	6-10			
		125	100-125	6-10			
		160	125-160	1280 A fixed			
	150	20	15-20	350 A fixed	NZMH2-A20 281281	S	
		25	20-25	6-10	NZMH2-A25 281282	S	
		32	25-32	350 A fixed	NZMH2-A32 281283	S	
		40	32-40	8-10	NZMH2-A40 259095	S	
		50	40-50	6-10	NZMH2-A50 259096	S	
		63	50-63	6-10	NZMH2-A63 259097	S	
		80	63-80	6-10	NZMH2-A80 259098	S	
		100	80-100	6-10	NZMH2-A100 259099	S	
		125	100-125	6-10	NZMH2-A125 259100	S	
		160	125-160	6-10	NZMH2-A160 259101	S	
		200	160-200	6-10	NZMH2-A200 259102	S	
		250	200-250	6-10	NZMH2-A250 259103	S	
		300	240-300	6-10	NZMH2-A300 107581	S	
		320	250-320	6-10	NZMH3-A320 109673	S	
		400	320-400	6-10	NZMH3-A400 109674	S	
500	400-500	6-10	NZMH3-A500 109675	S			



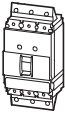

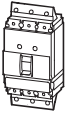
Fixed mounting with box terminals			Plug-in units			
Part no. Article no.	Price See price list		Part no. Article no.	Price See price list	Std. pack	Notes
			Order base separately			
						B = box terminals S = screw terminals For further terminal types see accessories
NZMH1-A20 284376		B		NZMH1-A20-SVE 112795	1 off	IEC/EN 60947-2
NZMH1-A25 284377		B		NZMH1-A25-SVE 112796		
NZMH1-A32 284378		B		NZMH1-A32-SVE 112797		
NZMH1-A40 284379		B		NZMH1-A40-SVE 112798		
NZMH1-A50 284410		B		NZMH1-A50-SVE 112799		
NZMH1-A63 284411		B		NZMH1-A63-SVE 112800		
NZMH1-A80 284412		B		NZMH1-A80-SVE 112801		
NZMH1-A100 284413		B		NZMH1-A100-SVE 112802		
NZMH1-A125 284414		B		NZMH1-A125-SVE 112803		
NZMH1-A160 284415		B		-		
NZMH2-A20-BT 110296		B		NZMH2-A20-SVE 113351	1 off	
NZMH2-A25-BT 110297		B		NZMH2-A25-SVE 113352		
NZMH2-A32-BT 110298		B		NZMH2-A32-SVE 113353		
NZMH2-A40-BT 110287		B		NZMH2-A40-SVE 113328		
NZMH2-A50-BT 110288		B		NZMH2-A50-SVE 113329		
NZMH2-A63-BT 110289		B		NZMH2-A63-SVE 113330		
NZMH2-A80-BT 110290		B		NZMH2-A80-SVE 113331		
NZMH2-A100-BT 110291		B		NZMH2-A100-SVE 113332		
NZMH2-A125-BT 110292		B		NZMH2-A125-SVE 113333		
NZMH2-A160-BT 110293		B		NZMH2-A160-SVE 113334		
NZMH2-A200-BT 110294		B	NZMH2-A200-SVE 113335			
NZMH2-A250-BT 110295		B	NZMH2-A250-SVE 113336			
NZMH2-A300-BT 110286		B	-			
NZMH3-A320-BT 110305		B		NZMH3-A320-AVE 110861		
NZMH3-A400-BT 110306		B		NZMH3-A400-AVE 110862		
NZMH3-A500-BT 110307		B		NZMH3-A500-AVE 110863		



Switching capacity 400/415 V 50/60 Hz	Rated current = Rated uninterrupted current	Setting range		Rated operational power AC-3 50/60 Hz	Rated operational current	Fixed mounting with screw terminals Part no. Article no.	Price See price list		
		Overload releases	Short-circuit releases Non-delayed						
I_{cu} kA	$I_n = I_u$ A	I_r A	$I_i = I_n \times \dots$	400 V P kW	400 V I_e A				
									
Motor protection									
<ul style="list-style-type: none"> NZM...1-M...: with phase failure sensitivity Tripping class 10 A 									
Basic switching capacity									
	25	40	32-40	8-14	18.5	36	Screw terminals as accessories		
		50	40-50	8-14	22	41			
		63	50-63	8-14	30	55			
		80	63-80	8-14	37	68			
		100	80-100	8-12.5	45	81			
		125	100-125	8-14	45	99		NZMB2-M125 265715	S
		160	125-160	8-14	75	134		NZMB2-M160 265716	S
		200	160-200	8-14	110	196		NZMB2-M200 265717	S
Comfort switching capacity									
	36	40	32-40	8-14	18.5	36	Screw terminals as accessories		
		50	40-50	8-14	22	41			
		63	50-63	8-14	30	55			
		80	63-80	8-14	37	68			
		100	80-100	8-12.5	45	81			
		125	100-125	8-14	45	99		NZMC2-M125 271424	S
		160	125-160	8-14	75	134		NZMC2-M160 271425	S
		200	160-200	8-14	110	196		NZMC2-M200 271426	S
Normal switching capacity									
	50	40	32-40	8-14	18.5	36	Screw terminals as accessories		
		50	40-50	8-14	22	41			
		63	50-63	8-14	30	55			
		80	63-80	8-14	37	68			
		100	80-100	8-12.5	45	81			
		125	100-125	8-14	45	99		NZMN2-M125 265723	S
		160	125-160	8-14	75	134		NZMN2-M160 265724	S
		200	160-200	8-14	110	196		NZMN2-M200 265725	S

Fixed mounting with box terminals			Plug-in units													
Part no. Article no.	Price See price list		Part no. Article no.	Price See price list	Std. pack	Notes										
			Order base separately													
						B = box terminals S = screw terminals For further terminal types see accessories										
NZMB1-M40 265710		B		NZMB1-M40-SVE 112709	1 off	IEC/EN 60947-4-1, IEC/EN 60947-2 The circuit-breakers fulfill all requirements for utilization category AC-3.										
NZMB1-M50 265711	B	NZMB1-M50-SVE 112720														
NZMB1-M63 265712	B	NZMB1-M63-SVE 112721														
NZMB1-M80 265713	B	NZMB1-M80-SVE 112722														
NZMB1-M100 265714	B	NZMB1-M100-SVE 112723														
Terminals as accessory				NZMB2-M125-SVE 113196		<table border="1"> <thead> <tr> <th>Tripping class</th> <th>Tripping time T_p with load on all poles of 7.2 times set current value.</th> </tr> </thead> <tbody> <tr> <td>10 A</td> <td>$2 s < T_p \leq 10 s$</td> </tr> <tr> <td>10</td> <td>$4 s < T_p \leq 10 s$</td> </tr> <tr> <td>20</td> <td>$6 s < T_p \leq 20 s$</td> </tr> <tr> <td>30</td> <td>$9 s < T_p \leq 30 s$</td> </tr> </tbody> </table>	Tripping class	Tripping time T_p with load on all poles of 7.2 times set current value.	10 A	$2 s < T_p \leq 10 s$	10	$4 s < T_p \leq 10 s$	20	$6 s < T_p \leq 20 s$	30	$9 s < T_p \leq 30 s$
Tripping class	Tripping time T_p with load on all poles of 7.2 times set current value.															
10 A	$2 s < T_p \leq 10 s$															
10	$4 s < T_p \leq 10 s$															
20	$6 s < T_p \leq 20 s$															
30	$9 s < T_p \leq 30 s$															
			NZMB2-M160-SVE 113197													
			NZMB2-M200-SVE 113198													
NZMC1-M40 271398		B		NZMC1-M40-SVE 112743	1 off											
NZMC1-M50 271399	B	NZMC1-M50-SVE 112744														
NZMC1-M63 271400	B	NZMC1-M63-SVE 112745														
NZMC1-M80 271401	B	NZMC1-M80-SVE 112746														
NZMC1-M100 271402	B	NZMC1-M100-SVE 112747														
Terminals as accessory				NZMC2-M125-SVE 113223												
				NZMC2-M160-SVE 113224												
				NZMC2-M200-SVE 113225												
NZMN1-M40 265718		B		NZMN1-M40-SVE 112763	1 off											
NZMN1-M50 265719	B	NZMN1-M50-SVE 112764														
NZMN1-M63 265720	B	NZMN1-M63-SVE 112765														
NZMN1-M80 265721	B	NZMN1-M80-SVE 112766														
NZMN1-M100 265722	B	NZMN1-M100-SVE 112767														
Terminals as accessory				NZMN2-M125-SVE 113250												
				NZMN2-M160-SVE 113251												
				NZMN2-M200-SVE 113252												







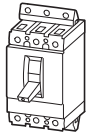





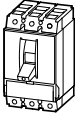

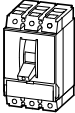
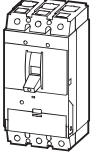





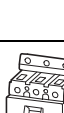

Switching capacity 400/415 V 50/60 Hz	Rated current = Rated uninterrupted current	Setting range		Rated operational power AC-3 50/60 Hz	Rated operational current	Fixed mounting with screw terminals Part no. Article no.	Price See price list	
		Overload releases	Short-circuit releases Non-delayed					
I_{cu} kA	$I_n = I_u$ A	I_r A	$I_i = I_n \times \dots$	400 V P kW	400 V I_e A			
								
Motor protection								
<ul style="list-style-type: none"> NZM...1-M...: with phase failure sensitivity Tripping class 10 A 								
High switching capacity								
	100	40	32-40	8-14	18.5	36	Screw terminals as accessories	
		50	40-50	8-14	22	41		
		63	50-63	8-14	30	55		
		80	63-80	8-14	37	68		
		100	80-100	8-12.5	45	81		
	150	20	16-20	350 A fixed	7.5	16	NZMH2-M20 281299	S
		25	20-25	350 A fixed	11	21.7	NZMH2-M25 281300	S
		32	25-32	10-14	15	29.3	NZMH2-M32 281301	S
		40	32-40	8-14	18.5	36	NZMH2-M40 281302	S
		50	40-50	8-14	22	41	NZMH2-M50 281303	S
		63	50-63	8-14	30	55	NZMH2-M63 281304	S
		80	63-80	8-14	37	68	NZMH2-M80 281305	S
		100	80-100	8-14	45	81	NZMH2-M100 281306	S
		125	100-125	8-14	45	99	NZMH2-M125 281307	S
		160	125-160	8-14	75	134	NZMH2-M160 281308	S
		200	160-200	8-14	110	196	NZMH2-M200 281309	S



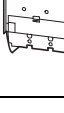

Fixed mounting with box terminals			Plug-in units													
Part no. Article no.	Price See price list		Part no. Article no.	Price See price list	Std. pack	Notes										
			Order base separately													
						B = box terminals S = screw terminals For further terminal types see accessories										
NZMH1-M40 115450		B		NZMH1-M40-SVE 115790	1 off	IEC/EN 60947-4-1, IEC/EN 60947-2 The circuit-breakers fulfill all requirements for utilization category AC-3.										
NZMH1-M50 115451		B		NZMH1-M50-SVE 115791												
NZMH1-M63 115452		B		NZMH1-M63-SVE 115792												
NZMH1-M80 115453		B		NZMH1-M80-SVE 115793												
NZMH1-M100 115454		B		NZMH1-M100-SVE 115794												
Terminals as accessory				NZMH2-M20-SVE 113354		<table border="1"> <thead> <tr> <th>Tripping class</th> <th>Tripping time T_p with load on all poles of 7.2 times set current value.</th> </tr> </thead> <tbody> <tr> <td>10 A</td> <td>$2 s < T_p \leq 10 s$</td> </tr> <tr> <td>10</td> <td>$4 s < T_p \leq 10 s$</td> </tr> <tr> <td>20</td> <td>$6 s < T_p \leq 20 s$</td> </tr> <tr> <td>30</td> <td>$9 s < T_p \leq 30 s$</td> </tr> </tbody> </table>	Tripping class	Tripping time T_p with load on all poles of 7.2 times set current value.	10 A	$2 s < T_p \leq 10 s$	10	$4 s < T_p \leq 10 s$	20	$6 s < T_p \leq 20 s$	30	$9 s < T_p \leq 30 s$
Tripping class	Tripping time T_p with load on all poles of 7.2 times set current value.															
10 A	$2 s < T_p \leq 10 s$															
10	$4 s < T_p \leq 10 s$															
20	$6 s < T_p \leq 20 s$															
30	$9 s < T_p \leq 30 s$															
				NZMH2-M25-SVE 113355												
				NZMH2-M32-SVE 113356												
				NZMH2-M40-SVE 113357												
				NZMH2-M50-SVE 113358												
				NZMH2-M63-SVE 113359												
				NZMH2-M80-SVE 113360												
			NZMH2-M100-SVE 113361													
			NZMH2-M125-SVE 113362													
			NZMH2-M160-SVE 113363													
			NZMH2-M200-SVE 113364													





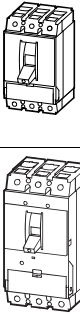

Switching capacity 400/415 V 50/60 Hz	Rated current = Rated uninterrupted current	Setting range	Rated operational power AC-3 50/60 Hz	Rated operational current AC-3 50/60 Hz	Fixed mounting with screw terminals Part no. Article no.	Price See price list		
I_{cu} kA	$I_n = I_u$ A	Short-circuit releases Non-delayed $I_i = I_n \times \dots$ 	400 V P kW	400 V I_e A				
Short-circuit protection								
Motor protection in conjunction with overload relay								
<ul style="list-style-type: none"> • With short-circuit releases • Without overload releases! 								
Basic switching capacity								
	25	40	8-14	18.5	max. 36	Screw terminals as accessories		
		50	8-14	22	max. 41			
		63	8-14	30	max. 55			
		80	8-14	37	max. 68			
		100	8-12.5	45	max. 99			
		125	8-14	45	max. 99		NZMB2-S125 265736	S
		160	8-14	75	max. 134		NZMB2-S160 265737	S
		200	8-12.5	110	max. 196		NZMB2-S200 265738	S
Comfort switching capacity								
	36	40	8-14	18.5	max. 36	Screw terminals as accessories		
		50	8-14	22	max. 41			
		63	8-14	30	max. 55			
		80	8-14	37	max. 68			
		100	8-12.5	45	max. 99			
		125	8-14	45	max. 99		NZMC2-S125 271427	S
		160	8-14	75	max. 134		NZMC2-S160 271428	S
		200	8-12.5	110	max. 196		NZMC2-S200 271429	S
	250	8-14	132	max. 231	NZMC3-S250 109676	S		
	320	8-14	160	max. 279	NZMC3-S320 109677	S		
	400	6-10	200	max. 349	NZMC3-S400 109678	S		
	500	6-10	250	max. 437	NZMC3-S500 109679	S		
Normal switching capacity								
	50	40	8-14	18.5	max. 36	Screw terminals as accessories		
		50	8-14	22	max. 41			
		63	8-14	30	max. 55			
		80	8-14	37	max. 68			
		100	8-12.5	45	max. 99			

Fixed mounting with box terminals			Plug-in/withdrawable units																																												
Part no. Article no.	Price See price list		Part no. Article no.	Price See price list	Std. pack	Notes																																									
			Order base separately																																												
						B = box terminals S = screw terminals For further terminal types see accessories																																									
NZMB1-S40 265726 NZMB1-S50 265727 NZMB1-S63 265728 NZMB1-S80 265729 NZMB1-S100 265730 Terminals as accessory		B  B  B  B  B  	NZMB1-S40-SVE 112724 NZMB1-S50-SVE 112725 NZMB1-S63-SVE 112726 NZMB1-S80-SVE 112727 NZMB1-S100-SVE 112728 NZMB2-S125-SVE 113199 NZMB2-S160-SVE 113200 NZMB2-S200-SVE 113201		1 off	IEC/EN 60947-4-1, IEC/EN 60947-2 The circuit-breakers fulfill all requirements for utilization category AC-3. <table border="1"> <thead> <tr> <th>Tripping class</th> <th>Tripping time T_p with load on all poles of 7.2 times set current value.</th> </tr> </thead> <tbody> <tr> <td>10 A</td> <td>$2 s < T_p \leq 10 s$</td> </tr> <tr> <td>10</td> <td>$4 s < T_p \leq 10 s$</td> </tr> <tr> <td>20</td> <td>$6 s < T_p \leq 20 s$</td> </tr> <tr> <td>30</td> <td>$9 s < T_p \leq 30 s$</td> </tr> </tbody> </table> Selection of circuit-breakers without overload release when combining for instance with ZEV electronic motor-protective relays: The tripping response of the motor-protective relay is matched by setting the tripping class to match the starting behavior of the motor to be protected.	Tripping class	Tripping time T_p with load on all poles of 7.2 times set current value.	10 A	$2 s < T_p \leq 10 s$	10	$4 s < T_p \leq 10 s$	20	$6 s < T_p \leq 20 s$	30	$9 s < T_p \leq 30 s$																															
Tripping class	Tripping time T_p with load on all poles of 7.2 times set current value.																																														
10 A	$2 s < T_p \leq 10 s$																																														
10	$4 s < T_p \leq 10 s$																																														
20	$6 s < T_p \leq 20 s$																																														
30	$9 s < T_p \leq 30 s$																																														
NZMC1-S40 271403 NZMC1-S50 271404 NZMC1-S63 271405 NZMC1-S80 271406 NZMC1-S100 271407 Terminals as accessory		B  B  B  B  B  	NZMC1-S40-SVE 112748 NZMC1-S50-SVE 112749 NZMC1-S63-SVE 112750 NZMC1-S80-SVE 112751 NZMC1-S100-SVE 112752 NZMC2-S125-SVE 113226 NZMC2-S160-SVE 113227 NZMC2-S200-SVE 113228 NZMC3-S250-AVE 113512 NZMC3-S320-AVE 113513 NZMC3-S400-AVE 113514 NZMC3-S500-AVE 113515		1 off	<table border="1"> <thead> <tr> <th></th> <th>I_n in A</th> <th>Maximum permissible tripping class</th> </tr> </thead> <tbody> <tr> <td rowspan="5">NZM...1-S...</td> <td>40</td> <td>30</td> </tr> <tr> <td>50</td> <td>30</td> </tr> <tr> <td>63</td> <td>30</td> </tr> <tr> <td>80</td> <td>20</td> </tr> <tr> <td>100</td> <td>15</td> </tr> <tr> <td rowspan="7">NZM...2-S...</td> <td>40</td> <td>30</td> </tr> <tr> <td>50</td> <td>30</td> </tr> <tr> <td>63</td> <td>30</td> </tr> <tr> <td>80</td> <td>30</td> </tr> <tr> <td>100</td> <td>30</td> </tr> <tr> <td>125</td> <td>30</td> </tr> <tr> <td>160</td> <td>20</td> </tr> <tr> <td rowspan="5">NZM...3-S...</td> <td>250</td> <td>30</td> </tr> <tr> <td>320</td> <td>30</td> </tr> <tr> <td>400</td> <td>30</td> </tr> <tr> <td>500</td> <td>20</td> </tr> <tr> <td></td> <td></td> <td></td> </tr> </tbody> </table>		I_n in A	Maximum permissible tripping class	NZM...1-S...	40	30	50	30	63	30	80	20	100	15	NZM...2-S...	40	30	50	30	63	30	80	30	100	30	125	30	160	20	NZM...3-S...	250	30	320	30	400	30	500	20			
	I_n in A	Maximum permissible tripping class																																													
NZM...1-S...	40	30																																													
	50	30																																													
	63	30																																													
	80	20																																													
	100	15																																													
NZM...2-S...	40	30																																													
	50	30																																													
	63	30																																													
	80	30																																													
	100	30																																													
	125	30																																													
	160	20																																													
NZM...3-S...	250	30																																													
	320	30																																													
	400	30																																													
	500	20																																													
NZMN1-S40 265731 NZMN1-S50 265732 NZMN1-S63 265733 NZMN1-S80 265734 NZMN1-S100 265735		B  B  B  B  B 	NZMN1-S40-SVE 112768 NZMN1-S50-SVE 112769 NZMN1-S63-SVE 112770 NZMN1-S80-SVE 112771 NZMN1-S100-SVE 112772		1 off																																										



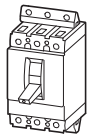

Switching capacity 400/415 V 50/60 Hz	Rated current = Rated uninterrupted current	Setting range	Rated operational power AC-3 50/60 Hz	Rated operational current AC-3 50/60 Hz	Fixed mounting with screw terminals Part no. Article no.	Price See price list	
							I_{cu} kA
Short-circuit protection							
Motor protection in conjunction with overload relay							
<ul style="list-style-type: none"> • With short-circuit release • Without overload release I_r 							
Normal switching capacity							
	50	125	8-14	45	max. 99	NZMN2-S125 265739	S
		160	8-14	75	max. 134	NZMN2-S160 265740	S
		200	8-12.5	110	max. 196	NZMN2-S200 265741	S
		250	8-14	132	max. 231	NZMN3-S250 109680	S
		320	8-14	160	max. 279	NZMN3-S320 109681	S
		400	6-10	200	max. 349	NZMN3-S400 109682	S
		500	6-10	250	max. 437	NZMN3-S500 109683	S
High switching capacity							
	100	40	8-14	18.5	max. 36	Screw terminals as accessories	
		50	8-14	22	max. 41		
		63	8-14	30	max. 55		
		80	8-14	37	max. 68		
		100	8-12.5	45	max. 99		
	150	40	8-14	18.5	max. 36	NZMH2-S40 265742	S
		50	8-14	22	max. 41	NZMH2-S50 265743	S
		63	8-14	30	max. 55	NZMH2-S63 265744	S
		80	8-14	37	max. 68	NZMH2-S80 265745	S
		100	8-14	45	max. 99	NZMH2-S100 265746	S
		125	8-14	45	max. 99	NZMH2-S125 265747	S
		160	8-14	75	max. 134	NZMH2-S160 265748	S
		200	8-12.5	110	max. 196	NZMH2-S200 265749	S
		250	8-14	132	max. 231	NZMH3-S250 109684	S
		320	8-14	160	max. 279	NZMH3-S320 109685	S
		400	6-10	200	max. 349	NZMH3-S400 109686	S
500	6-10	250	max. 437	NZMH3-S500 109687	S		

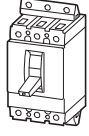
HPL17021EN

Fixed mounting with box terminals		Plug-in/withdrawable units		Std. pack	Notes																																						
Part no. Article no.	Price See price list	Part no. Article no.	Price See price list																																								
			Order base separately																																								
					B = box terminals S = screw terminals For further terminal types see accessories																																						
Terminals as accessory			NZM2-S125-SVE 113253 NZM2-S160-SVE 113254 NZM2-S200-SVE 113255 NZM3-S250-AVE 113523 NZM3-S320-AVE 113524 NZM3-S400-AVE 113525 NZM3-S500-AVE 113526	1 off	IEC/EN 60947-4-1, IEC/EN 60947-2 The circuit-breakers fulfill all requirements for utilization category AC-3. <table border="1"> <thead> <tr> <th>Tripping class</th> <th>Tripping time T_p with load on all poles of 7.2 times set current value.</th> </tr> </thead> <tbody> <tr> <td>10 A</td> <td>$2 s < T_p \leq 10 s$</td> </tr> <tr> <td>10</td> <td>$4 s < T_p \leq 10 s$</td> </tr> <tr> <td>20</td> <td>$6 s < T_p \leq 20 s$</td> </tr> <tr> <td>30</td> <td>$9 s < T_p \leq 30 s$</td> </tr> </tbody> </table>	Tripping class	Tripping time T_p with load on all poles of 7.2 times set current value.	10 A	$2 s < T_p \leq 10 s$	10	$4 s < T_p \leq 10 s$	20	$6 s < T_p \leq 20 s$	30	$9 s < T_p \leq 30 s$																												
Tripping class	Tripping time T_p with load on all poles of 7.2 times set current value.																																										
10 A	$2 s < T_p \leq 10 s$																																										
10	$4 s < T_p \leq 10 s$																																										
20	$6 s < T_p \leq 20 s$																																										
30	$9 s < T_p \leq 30 s$																																										
NZMH1-S40 284436 NZMH1-S50 284437 NZMH1-S63 284438 NZMH1-S80 284439 NZMH1-S100 284440		B  B  B  B B 	NZMH1-S40-SVE 112805 NZMH1-S50-SVE 112806 NZMH1-S63-SVE 112807 NZMH1-S80-SVE 112808 NZMH1-S100-SVE 112809	1 off	Selection of circuit-breakers without overload release when combining for instance with ZEV electronic motor-protective relays: The tripping response of the motor-protective relay is matched by setting the tripping class to match the starting behavior of the motor to be protected.																																						
Terminals as accessory			NZMH2-S40-SVE 113340 NZMH2-S50-SVE 113341 NZMH2-S63-SVE 113342 NZMH2-S80-SVE 113343 NZMH2-S100-SVE 113344 NZMH2-S125-SVE 113345 NZMH2-S160-SVE 113346 NZMH2-S200-SVE 113347 NZMH3-S250-AVE 113566 NZMH3-S320-AVE 113567 NZMH3-S400-AVE 113568 NZMH3-S500-AVE 113569		<table border="1"> <thead> <tr> <th></th> <th>I_n in A</th> <th>Maximum permissible tripping class</th> </tr> </thead> <tbody> <tr> <td rowspan="5">NZM...1-S...</td> <td>40</td> <td>30</td> </tr> <tr> <td>50</td> <td>30</td> </tr> <tr> <td>63</td> <td>30</td> </tr> <tr> <td>80</td> <td>20</td> </tr> <tr> <td>100</td> <td>15</td> </tr> <tr> <td rowspan="7">NZM...2-S...</td> <td>40</td> <td>30</td> </tr> <tr> <td>50</td> <td>30</td> </tr> <tr> <td>63</td> <td>30</td> </tr> <tr> <td>80</td> <td>30</td> </tr> <tr> <td>100</td> <td>30</td> </tr> <tr> <td>125</td> <td>30</td> </tr> <tr> <td>160</td> <td>20</td> </tr> <tr> <td rowspan="5">NZM...3-S...</td> <td>250</td> <td>30</td> </tr> <tr> <td>320</td> <td>30</td> </tr> <tr> <td>400</td> <td>30</td> </tr> <tr> <td>500</td> <td>20</td> </tr> </tbody> </table>		I_n in A	Maximum permissible tripping class	NZM...1-S...	40	30	50	30	63	30	80	20	100	15	NZM...2-S...	40	30	50	30	63	30	80	30	100	30	125	30	160	20	NZM...3-S...	250	30	320	30	400	30	500	20
	I_n in A	Maximum permissible tripping class																																									
NZM...1-S...	40	30																																									
	50	30																																									
	63	30																																									
	80	20																																									
	100	15																																									
NZM...2-S...	40	30																																									
	50	30																																									
	63	30																																									
	80	30																																									
	100	30																																									
	125	30																																									
	160	20																																									
NZM...3-S...	250	30																																									
	320	30																																									
	400	30																																									
	500	20																																									



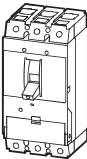
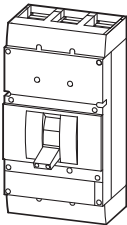
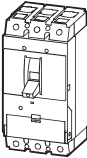
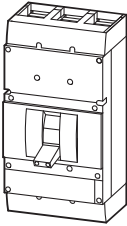
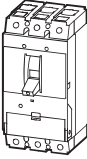



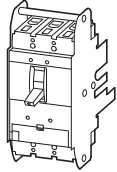
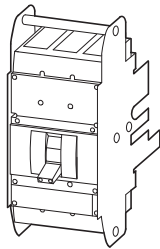
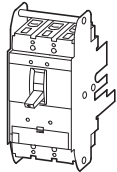
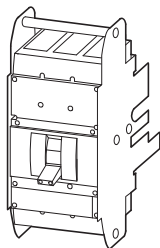
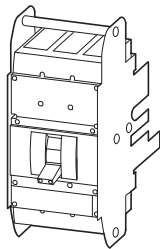



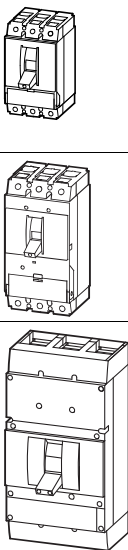
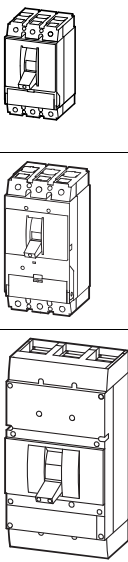
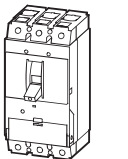

	Switching capacity 400/415 V 50/60 Hz	Rated current = Rated uninterrupted current	Setting range		Fixed mounting with screw terminals Part no. Article no.	Price See price list
			Overload releases	Short-circuit releases Non-delayed		
	I_{cu} kA	$I_n = I_u$ A				
System and cable protection						
Normal switching capacity						
	50	630	315-630	2-8	NZMN3-AE630 259115	S
	50	630	315-630	2-12	NZMN4-AE630 265758	S
		800	400-800	2-12	NZMN4-AE800 265759	S
		1000	500-1000	2-12	NZMN4-AE1000 265760	S
		1250	630-1250	2-12	NZMN4-AE1250 265761	S
		1600	800-1600	2-12	NZMN4-AE1600 265762	S
High switching capacity						
	150	630	315-630	2-8	NZMH3-AE630 259118	S
	85	630	315-630	2-12	NZMH4-AE630 265763	S
		800	400-800	2-12	NZMH4-AE800 265764	S
		1000	500-1000	2-12	NZMH4-AE1000 265765	S
		1250	630-1250	2-12	NZMH4-AE1250 265766	S
		1600	800-1600	2-12	NZMH4-AE1600 265767	S
Earth fault protection						
	50	250	125-250	2-11	NZMN3-AE250-T 110888	S
		400	200-400	2-11	NZMN3-AE400-T 110889	S
		630	315-630	2-8	NZMN3-AE630-T 110890	S
	150	250	125-250	2-11	NZMH3-AE250-T 110894	S
		400	200-400	2-11	NZMH3-AE400-T 110895	S
		630	315-630	2-8	NZMH3-AE630-T 110896	S

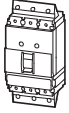
HPL17023EN

Fixed mounting with box terminals			Withdrawable units			
Part no. Article no.	Price See price list		Part no. Article no.	Price See price list	Std. pack	Notes
			Order base separately			
						B = box terminals S = screw terminals For further terminal types see accessories
NZMN3-AE630-BT 111656		B 	NZMN3-AE630-AVE 110842		1 off	IEC/EN 60947-2 R.m.s. value measurement and "thermal memory"
Terminals as accessory			Withdrawable units as accessories			
Terminals as accessory			NZMH3-AE630-AVE 110851		1 off	
Terminals as accessory			Withdrawable units as accessories			
Terminals as accessory			NZMN3-AE250-T-AVE 113527 NZMN3-AE400-T-AVE 113528 NZMN3-AE630-T-AVE 113093 NZMH3-AE250-T-AVE 113570 NZMH3-AE400-T-AVE 113571 NZMH3-AE630-T-AVE 113572		1 off	

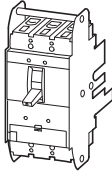
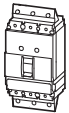

	Switching capacity 400/415 V 50/60 Hz	Rated current = Rated uninterrupted current	Setting range		Fixed mounting with screw terminals	Part no. Article no.	Price See price list			
			I_{cu} kA	$I_n = I_u$ A				Overload releases	Short-circuit releases	
									Non-delayed	Delayed
			I_r A	$I_i = I_n \times \dots$	$I_{sd} = I_r \times \dots$					
										
Systems protection, cable protection, selectivity, generator protection										
Normal switching capacity										
	50	100	50-100	1200 A fixed	2-10	NZMN2-VE100 259122	S			
		160	80-160	1920 A fixed	2-10	NZMN2-VE160 259123	S			
		250	125-250	3000 A fixed	2-10	NZMN2-VE250 259124	S			
		250	125-250	2-11	2-10	NZMN3-VE250 259131	S			
		400	200-400	2-11	2-10	NZMN3-VE400 259132	S			
		630	315-630	2-8	1.5-7	NZMN3-VE630 259133	S			
		630	315-630	2-12	1.5-7	NZMN4-VE630 265768	S			
		800	400-800	2-12	2-10	NZMN4-VE800 265769	S			
		1000	500-1000	2-12	2-10	NZMN4-VE1000 265770	S			
		1250	630-1250	2-12	2-10	NZMN4-VE1250 265771	S			
1600	800-1600	2-12	2-10	NZMN4-VE1600 265772	S					
High switching capacity										
	150	100	50-100	1200 A fixed	2-10	NZMH2-VE100 259125	S			
		160	80-160	1920 A fixed	2-10	NZMH2-VE160 259126	S			
		250	125-250	3000 A fixed	2-10	NZMH2-VE250 259127	S			
		250	125-250	2-11	2-10	NZMH3-VE250 259134	S			
		400	200-400	2-11	2-10	NZMH3-VE400 259135	S			
		630	315-630	2-8	1.5-7	NZMH3-VE630 259136	S			
	85	630	315-630	2-12	1.5-7	NZMH4-VE630 265773	S			
		800	400-800	2-12	2-10	NZMH4-VE800 265774	S			
		1000	500-1000	2-12	2-10	NZMH4-VE1000 265775	S			
		1250	630-1250	2-12	2-10	NZMH4-VE1250 265776	S			
1600	800-1600	2-12	2-10	NZMH4-VE1600 265777	S					
Earth fault protection										
	50	250	125-250	2-11	2-10	NZMN3-VE250-T 110891	S			
		400	200-400	2-11	2-10	NZMN3-VE400-T 110892	S			
		630	315-630	2-8	1.5-7	NZMN3-VE630-T 110893	S			
	150	250	125-250	2-11	2-10	NZMH3-VE250-T 110897	S			
		400	200-400	2-11	2-10	NZMH3-VE400-T 110898	S			
		630	315-630	2-8	1.5-7	NZMH3-VE630-T 110899	S			

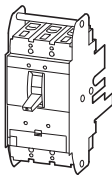
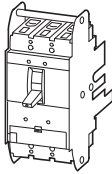
Fixed mounting with box terminals		Plug-in/withdrawable units		Std. pack	Notes
Part no. Article no.	Price See price list	Part no. Article no.	Price See price list		
		Order base separately			
					B = box terminals S = screw terminals For further terminal types see accessories
Terminals as accessory			NZM2-VE100-SVE 113247	1 off	IEC/EN 60947-2 R.m.s. value measurement and "thermal memory" Adjustable delay setting t_r • 2 – 20 s at 6 x I_n and infinite (without overload release) Adjustable delay t_{sd} • Steps: 0, 20, 60, 100, 200, 300, 500, 750, 1000 ms i^2t constant function • NZM2 fixed OFF • NZM3, NZM4 switchable
			NZM2-VE160-SVE 113248		
			NZM2-VE250-SVE 113249		
			NZM3-VE250-AVE 110843		
NZMN3-VE400-BT 111659	1,467.37 43	B 	NZMN3-VE400-AVE 110844		
NZMN3-VE630-BT 111730	1,914.22 43	B 	NZMN3-VE630-AVE 110845		
Terminals as accessory			Withdrawable units as accessories		
Terminals as accessory			NZMH2-VE100-SVE 113337	1 off	
			NZMH2-VE160-SVE 113338		
			NZMH2-VE250-SVE 113339		
			NZMH3-VE250-AVE 110852		
NZMH3-VE400-BT 111731	1,668.52 43	B 	NZMH3-VE400-AVE 110853		
NZMH3-VE630-BT 111732	2,079.92 43	B 	NZMH3-VE630-AVE 110854		
Terminals as accessory			Withdrawable units as accessories		
Terminals as accessory			NZMN3-VE250-T-AVE 113529	1 off	
			NZMN3-VE400-T-AVE 113530		
			NZMN3-VE630-T-AVE 113531		
			NZMH3-VE250-T-AVE 113573		
			NZMH3-VE400-T-AVE 113574		
			NZMH3-VE630-T-AVE 113575		



Switching capacity 400/415 V 50/60 Hz	Rated current = Rated uninterrupted current	Setting range		Rated operational power AC-3 50/60 Hz		Rated operational current AC-3 50/60 Hz		Fixed mounting with screw terminals Part no. Article no.	Price See price list		
		Overload releases	Short-circuit releases	Non-delayed		400 V				690 V	
				I_r	$I_i = I_n \times \dots$	P	P			I_e	I_e
I_{cu} kA	$I_n = I_u$ A	I_r A		400 V	690 V	400 V	690 V				
				kW	kW	A	A				



Motor protection

With phase-failure sensitivity

Normal switching capacity

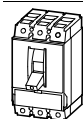

50	90	45-90	2-14	45	75	81	78		
	140	70-140	2-14	75	132	134	134	NZMN2-ME90 265778	S
	220	110-220	2-14	110	200	196	202	NZMN2-ME140 265779	S
	220	110-220	2-14	110	200	196	202	NZMN2-ME220 265780	S
	350	175-350	2-14	200	315	349	316	NZMN3-ME220 265781	S
	450	225-450	2-12	250	450	437	446	NZMN3-ME350 265782	S
	550	275-550	2-14	315	560	544	550	NZMN3-ME450 284468	S
	875	438-875	2-14	500	600	820	588	NZMN4-ME550 265783	S
	1400	700-1400	2-14	630	600	1066	588	NZMN4-ME875 265784	S
								NZMN4-ME1400 265785	S

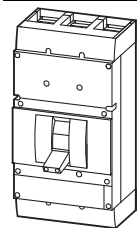
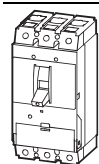

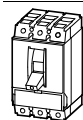

High switching capacity



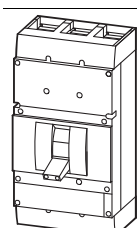
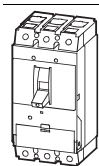

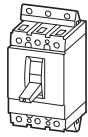
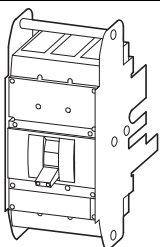
150	90	45-90	2-14	45	45	81	78		
	140	70-140	2-14	75	132	134	134	NZMH2-ME90 265786	S
	220	110-220	2-14	110	200	196	202	NZMH2-ME140 265787	S
	220	110-220	2-14	110	200	196	202	NZMH2-ME220 265788	S
	220	110-220	2-14	110	200	196	202	NZMH3-ME220 265789	S
	350	175-350	2-14	200	315	349	316	NZMH3-ME350 265790	S
	450	225-450	2-12	250	450	437	446	NZMH3-ME450 284469	S
	550	275-550	2-14	315	560	544	550	NZMH4-ME550 265791	S
	875	438-875	2-14	500	600	820	588	NZMH4-ME875 265792	S
	1400	700-1400	2-14	630	600	1066	588	NZMH4-ME1400 265793	S

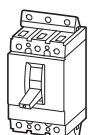
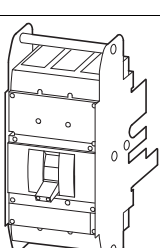

Plug-in units		Std. pack	Notes
Part no. Article no.	Price See price list		
Order base separately			
B = box terminals S = screw terminals For further terminal types see accessories			
	NZMN2-ME90-SVE 113256	1 off	IEC/EN 60947-4-1, IEC/EN 60947-2 The circuit-breakers fulfill all requirements for utilization category AC-3. R.m.s. value measurement and "thermal memory" Adjustable delay setting t_r • 2 – 20 s at 6 x I_r , and infinite (without overload release)
	NZMN2-ME140-SVE 113257		
	NZMN2-ME220-SVE 113258		
	NZMN3-ME220-AVE 110846		
	NZMN3-ME350-AVE 110847		
	NZMN3-ME450-AVE 110848		
	Withdrawable units as accessories		
	NZMH2-ME90-SVE 113348	1 off	
	NZMH2-ME140-SVE 113349		
	NZMH2-ME220-SVE 113350		
	NZMH3-ME220-AVE 110855		
	NZMH3-ME350-AVE 110856		
	NZMH3-ME450-AVE 110857		
	Withdrawable units as accessories		



Switching capacity 400/415 V 50/60 Hz	Rated current = Rated uninterrupted current		Setting range			Fixed mounting with screw terminals Part no. Article no.	Price See price list
	Phase conductors	Neutral conductor	Overload releases		Short-circuit releases Non-delayed		
			I_r	I_r			
I_{cu}	$I_n = I_u$	$I_r \times \% \text{ of phase conductor}$	I_r	I_r			
kA	A	%	A	A			
							

System and cable protection

Basic switching capacity



25	20	100	15-20	15...20	350 A fixed	Screw terminals as accessories		
	25	100	20-25	20...25	350 A fixed			
	32	100	25-32	25...32	350 A fixed			
	40	100	32-40	32...40	8-10			
	50	100	40-50	40...50	6-10			
	63	100	50-63	50...63	6-10			
	80	100	63-80	63...80	6-10			
	100	100	80-100	80...100	6-10			
	125	100	100-125	100...125	6-10			
	160	100	125-160	125...160	1280 A fixed			
	160	100	125-160	125...160	6-10		NZMB2-4-A160 265849	S
	160	60	125-160	80...100	6-10		NZMB2-4-A160/100 265850	S
	200	100	160-200	160...200	6-10		NZMB2-4-A200 265852	S
	200	60	160-200	100...125	6-10		NZMB2-4-A200/125 265853	S
	250	100	200-250	200...250	6-10		NZMB2-4-A250 265855	S
	250	60	200-250	125...160	6-10		NZMB2-4-A250/160 265856	S
	300	100	240-300	240...300	6-10		NZMB2-4-A300 107582	S
	300	60	240-300	160...200	6-10		NZMB2-4-A300/200 107583	S

Comfort switching capacity

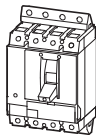

36	20	100	15-20	15...20	350 A fixed	Screw terminals as accessories		
	25	100	20-25	20...25	350 A fixed			
	32	100	25-32	25...32	350 A fixed			
	40	100	32-40	32...40	8-10			
	50	100	40-50	40...50	6-10			
	63	100	50-63	50...63	6-10			
	80	100	63-80	63...80	6-10			
	100	100	80-100	80...100	6-10			
	125	100	100-125	100...125	6-10			
	160	100	125-160	125...160	1280 A fixed			

Fixed mounting with box terminals		Plug-in units		Std. pack	Notes
Part no. Article no.	Price See price list	Part no. Article no.	Price See price list		
		Order base separately			
					B = box terminals S = screw terminals For further terminal types see accessories
NZMB1-4-A20 281237		B -	-	1 off	IEC/EN 60947-2 Set value for neutral conductor is same as set value I _n for main pole.
NZMB1-4-A25 281239		B	-		
NZMB1-4-A32 281241		B	-		
NZMB1-4-A40 265799		B	-		
NZMB1-4-A50 265801		B	-		
NZMB1-4-A63 265803		B	-		
NZMB1-4-A80 265805		B	-		
NZMB1-4-A100 265807		B	-		
NZMB1-4-A125 265809		B	-		
NZMB1-4-A160 281243		B	-		
Terminals as accessory			NZMB2-4-A160-SVE 113209 NZMB2-4-A160/100-SVE 113210 NZMB2-4-A200-SVE 113212 NZMB2-4-A200/125-SVE 113213 NZMB2-4-A250-SVE 113215 NZMB2-4-A250/160-SVE 113216 - -		
NZMC1-4-A20 283300		B -	-	1 off	
NZMC1-4-A25 283302		B	-		
NZMC1-4-A32 283304		B	-		
NZMC1-4-A40 271408		B	-		
NZMC1-4-A50 271410		B	-		
NZMC1-4-A63 271412		B	-		
NZMC1-4-A80 271414		B	-		
NZMC1-4-A100 271416		B	-		
NZMC1-4-A125 271418		B	-		
NZMC1-4-A160 283306		B	-		



Switching capacity 400/415 V 50/60 Hz	Rated current = Rated uninterrupted current		Setting range			Short-circuit releases Non-delayed $I_i = I_n \times \dots$	Fixed mounting with screw terminals Part no. Article no.	Price See price list
	I_{cu} kA	Phase conductors $I_n = I_u$ A	Neutral conductor $I_n \times \% \text{ of phase conductor}$ %	Overload releases				
				I_r A	Phase conductors I_r A			



System and cable protection

Comfort switching capacity

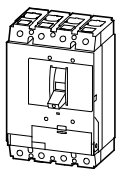
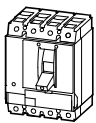

36								
	125	100	100-125	100...125	6-10	NZMC2-4-A125 271430		S
	160	100	125-160	125...160	6-10	NZMC2-4-A160 271432		S
	160	60	125-160	80...100	6-10	NZMC2-4-A160/100 271433		S
	200	100	160-200	160...200	6-10	NZMC2-4-A200 271435		S
	200	60	160-200	100...125	6-10	NZMC2-4-A200/125 271436		S
	250	100	200-250	200...250	6-10	NZMC2-4-A250 271438		S
	250	60	200-250	125...160	6-10	NZMC2-4-A250/160 271439		S
	300	100	240-300	240...300	6-10	NZMC2-4-A300 107584		S
	300	60	240-300	160...200	6-10	NZMC2-4-A300/200 107585		S
	320	100	250-320	250...320	6-10	NZMC3-4-A320 109688		S
	320	60	250-320	160...200	6-10	NZMC3-4-A320/200 109689		S
	400	100	320-400	320...400	6-10	NZMC3-4-A400 109690		S
	400	60	320-400	200...250	6-10	NZMC3-4-A400/250 109691		S
	500	100	400-500	400...500	6-10	NZMC3-4-A500 109692		S
	500	60	400-500	250...320	6-10	NZMC3-4-A500/320 109693		S



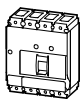

Normal switching capacity

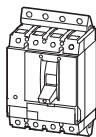
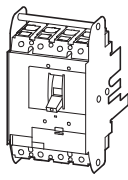

50								
	20	100	15-20	15...20	350 A fixed	Screw terminals as accessories		
	25	100	20-25	20...25	350 A fixed			
	32	100	25-32	25...32	350 A fixed			
	40	100	32-40	32...40	8-10			
	50	100	40-50	40...50	6-10			
	63	100	50-63	50...63	6-10			
	80	100	63-80	63...80	6-10			
	100	100	80-100	80...100	6-10			
	125	100	100-125	100...125	6-10			
	160	100	125-160	125...160	1280 A fixed			

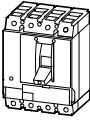

Fixed mounting with box terminals		Plug-in units		Std. pack	Notes
Part no. Article no.	Price See price list	Part no. Article no.	Price See price list		
		Order base separately			
					B = box terminals S = screw terminals For further terminal types see accessories
Terminals as accessory			NZMC2-4-A125-SVE 113231 NZMC2-4-A160-SVE 113233 NZMC2-4-A160/100-SVE 113234 NZMC2-4-A200-SVE 113236 NZMC2-4-A200/125-SVE 113237 NZMC2-4-A250-SVE 113239 NZMC2-4-A250/160-SVE 113240 - -	1 off	IEC/EN 60947-2 Set value for neutral conductor is same as set value I _n for main pole.
			NZMC3-4-A320-AVE 113516 NZMC3-4-A320/200-AVE 113517 NZMC3-4-A400-AVE 113518 NZMC3-4-A400/250-AVE 113519 NZMC3-4-A500-AVE 113520 NZMC3-4-A500/320-AVE 113521		
NZMN1-4-A20 281245		B	-		1 off
NZMN1-4-A25 281247		B	-		
NZMN1-4-A32 281249		B	-		
NZMN1-4-A40 265811		B	-		
NZMN1-4-A50 265813		B	-		
NZMN1-4-A63 265815		B	-		
NZMN1-4-A80 265817		B	-		
NZMN1-4-A100 265819		B	-		
NZMN1-4-A125 265821		B	-		
NZMN1-4-A160 281251		B	-		

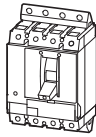
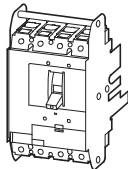

Switching capacity 400/415 V 50/60 Hz	Rated current = Rated uninterrupted current		Setting range			Fixed mounting with screw terminals Part no. Article no.	Price See price list	
	Phase conductors	Neutral conductor	Overload releases		Short-circuit releases			
			I_r	I_r	Non-delayed			
I_{cu}	$I_n = I_u$	$I_r \times \% \text{ of phase conductor}$	I_r	I_r	$I_i = I_n \times \dots$			
kA	A	%	A	A				
								
System and cable protection								
Normal switching capacity								
	50	160	100	125-160	125...160	6-10	NZMN2-4-A160 265860	S
		160	60	125-160	80...100	6-10	NZMN2-4-A160/100 265861	S
		200	100	160-200	160...200	6-10	NZMN2-4-A200 265863	S
		200	60	160-200	100...125	6-10	NZMN2-4-A200/125 265864	S
		250	100	200-250	200...250	6-10	NZMN2-4-A250 265866	S
		250	60	200-250	125...160	6-10	NZMN2-4-A250/160 265867	S
		300	100	240-300	240...300	6-10	NZMN2-4-A300 107586	S
		300	60	240-300	160...200	6-10	NZMN2-4-A300/200 107587	S
		320	100	250-320	250...320	6-10	NZMN3-4-A320 109694	S
		320	60	250-320	160...200	6-10	NZMN3-4-A320/200 109695	S
		400	100	320-400	320...400	6-10	NZMN3-4-A400 109696	S
		400	60	320-400	200...250	6-10	NZMN3-4-A400/250 109697	S
		500	100	400-500	400...500	6-10	NZMN3-4-A500 109698	S
		500	60	400-500	250...320	6-10	NZMN3-4-A500/320 109699	S
High switching capacity								
	100	20	100	15-20	15...20	350 A fixed	Screw terminals as accessories	
		25	100	20-25	20...25	350 A fixed		
		32	100	25-32	25...32	350 A fixed		
		40	100	32-40	32...40	8-10		
		50	100	40-50	40...50	6-10		
		63	100	50-63	50...63	6-10		
		80	100	63-80	63...80	6-10		
		100	100	80-100	80...100	6-10		
		125	100	100-125	100...125	6-10		
		160	100	125-160	125...160	1280 A fixed		

Fixed mounting with box terminals		Plug-in units		Std. pack	Notes
Part no. Article no.	Price See price list	Part no. Article no.	Price See price list		
		Order base separately			
					B = box terminals S = screw terminals For further terminal types see accessories
Terminals as accessory			NZMN2-4-A160-SVE 113266 NZMN2-4-A160/100-SVE 113267 NZMN2-4-A200-SVE 113269 NZMN2-4-A200/125-SVE 113270 NZMN2-4-A250-SVE 113272 NZMN2-4-A250/160-SVE 113273 - -	1 off	IEC/EN 60947-2 Set value for neutral conductor is same as set value I _n for main pole.
			NZMN3-4-A320-AVE 113532 NZMN3-4-A320/200-AVE 113533 NZMN3-4-A400-AVE 113534 NZMN3-4-A400/250-AVE 113535 NZMN3-4-A500-AVE 113536 NZMN3-4-A500/320-AVE 113537		
NZMH1-4-A20 284416		B -	-	1 off	
NZMH1-4-A25 284418		B	-		
NZMH1-4-A32 284420		B	-		
NZMH1-4-A40 284422		B	-		
NZMH1-4-A50 284424		B	-		
NZMH1-4-A63 284426		B	-		
NZMH1-4-A80 284428		B	-		
NZMH1-4-A100 284430		B	-		
NZMH1-4-A125 284432		B	-		
NZMH1-4-A160 284434		B	-		



Switching capacity 400/415 V 50/60 Hz	Rated current = Rated uninterrupted current		Setting range			Short-circuit releases Non-delayed $I_i = I_n \times \dots$	Fixed mounting with screw terminals Part no. Article no.	Price See price list
	Phase conductors $I_n = I_u$	Neutral conductor $I_n \times \% \text{ of phase conductor}$	Overload releases		Phase conductors			
			I_r	I_r				
I_{cu} kA	A	%	A	A				
								

System and cable protection

High switching capacity

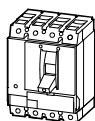



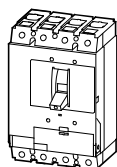

150	20	100	15-20	15...20	350 A fixed	NZMH2-4-A20 281287	S
	25	100	20-25	20...25	350 A fixed	NZMH2-4-A25 281289	S
	32	100	25-32	25...32	350 A fixed	NZMH2-4-A32 281291	S
	40	100	32-40	32...40	6-10	NZMH2-4-A40 265823	S
	50	100	40-50	40...50	6-10	NZMH2-4-A50 265825	S
	63	100	50-63	50...63	6-10	NZMH2-4-A63 265827	S
	80	100	63-80	63...80	6-10	NZMH2-4-A80 265829	S
	100	100	80-100	80...100	6-10	NZMH2-4-A100 265831	S
	125	100	100-125	100...125	6-10	NZMH2-4-A125 265833	S
	160	100	125-160	125...160	6-10	NZMH2-4-A160 265871	S
	160	60	125-160	80...100	6-10	NZMH2-4-A160/100 265872	S
	200	100	160-200	160...200	6-10	NZMH2-4-A200 265874	S
	200	60	160-200	100...125		NZMH2-4-A200/125 265875	S
	250	100	200-250	200...250	6-10	NZMH2-4-A250 265877	S
	250	60	200-250	125...160	6-10	NZMH2-4-A250/160 265878	S
300	100	240-300	240...300	6-10	NZMH2-4-A300 107588	S	
300	60	240-300	160...200	6-10	NZMH2-4-A300/200 107589	S	
150	320	100	250-320	250...320	6-10	NZMH3-4-A320 109700	S
	320	60	250-320	160...200	6-10	NZMH3-4-A320/200 109701	S
	400	100	320-400	320...400	6-10	NZMH3-4-A400 109702	S
	400	60	320-400	200...250	6-10	NZMH3-4-A400/250 109703	S
	500	100	400-500	400...500	6-10	NZMH3-4-A500 109704	S
	500	60	400-500	250...320	6-10	NZMH3-4-A500/320 109705	S

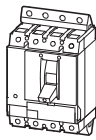
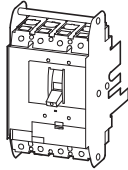

HPL17035EN

Fixed mounting with box terminals		Plug-in units		Std. pack	Notes
Part no. Article no.	Price See price list	Part no. Article no.	Price See price list		
		Order base separately			
					B = box terminals S = screw terminals For further terminal types see accessories
Terminals as accessory			NZMH2-4-A20-SVE 113396 NZMH2-4-A25-SVE 113398 NZMH2-4-A32-SVE 113400 NZMH2-4-A40-SVE 113367 NZMH2-4-A50-SVE 113369 NZMH2-4-A63-SVE 113371 NZMH2-4-A80-SVE 113373 NZMH2-4-A100-SVE 113375 NZMH2-4-A125-SVE 113377 NZMH2-4-A160-SVE 113379 NZMH2-4-A160/100-SVE 113380 NZMH2-4-A200-SVE 113382 NZMH2-4-A200/125-SVE 113383 NZMH2-4-A250-SVE 113385 NZMH2-4-A250/160-SVE 113386 - -	1 off	IEC/EN 60947-2 Set value for neutral conductor is same as set value I _n for main pole.
			NZMH3-4-A320-AVE 113578 NZMH3-4-A320/200-AVE 113579 NZMH3-4-A400-AVE 113580 NZMH3-4-A400/250-AVE 113581 NZMH3-4-A500-AVE 113582 NZMH3-4-A500/320-AVE 113583	1 off	

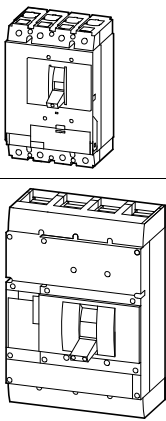
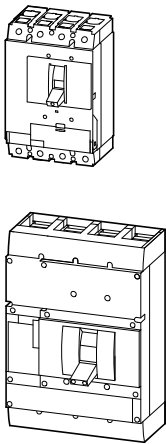
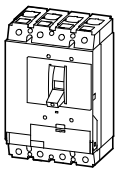

	Switching capacity 400/415 V 50/60 Hz	Rated current = Rated uninterrupted current		Setting range				Fixed mounting with screw terminals Part no. Article no.	Price See price list
		Phase conductors	Neutral conductor	Overload releases		Short-circuit releases			
				I_r	Phase conductors	Non- delayed	Delayed		
	I_{cu}	$I_n = I_u$	I_r x % of phase conductor	I_r	I_r	$I_i = I_n \times \dots$	$I_{sd} = I_r \times \dots$		
	kA	A	%	A	A				
									
System and cable protection									
Normal switching capacity									
	50	630	100	315-630	315...630	2-8	-	NZMN3-4-AE630 265894	S
		630	60	315-630	200...400	2-8	-	NZMN3-4-AE630/400 265895	S
	80	800	100	400-800	400...800	2-12	-	NZMN4-4-AE800 265909	S
		800	60	400-800	250...500	2-12	-	NZMN4-4-AE800/500 265910	S
		1000	100	500-1000	500...1000	2-12	-	NZMN4-4-AE1000 265912	S
		1000	60	500-1000	315...630	2-12	-	NZMN4-4-AE1000/630 265913	S
		1250	100	630-1250	630...1250	2-12	-	NZMN4-4-AE1250 265915	S
		1250	60	630-1250	400...800	2-12	-	NZMN4-4-AE1250/800 265916	S
		1600	100	800-1600	800...1600	2-12	-	NZMN4-4-AE1600 265918	S
1600	60	800-1600	500...1000	2-12	-	NZMN4-4-AE1600/1000 265919	S		
High switching capacity									
	150	630	100	315-630	315...630	2-8	-	NZMH3-4-AE630 265900	S
		630	60	315-630	200...400	2-8	-	NZMH3-4-AE630/400 265901	S
	85	800	100	400-800	400...800	2-12	-	NZMH4-4-AE800 265921	S
		800	60	400-800	250...500	2-12	-	NZMH4-4-AE800/500 265922	S
		1000	100	500-1000	500...1000	2-12	-	NZMH4-4-AE1000 265924	S
		1000	60	500-1000	315...630	2-12	-	NZMH4-4-AE1000/630 265925	S
		1250	100	630-1250	630...1250	2-12	-	NZMH4-4-AE1250 265927	S
		1250	60	630-1250	400...800	2-12	-	NZMH4-4-AE1250/800 265928	S
		1600	100	800-1600	800...1600	2-12	-	NZMH4-4-AE1600 265930	S
		1600	60	800-1600	500...1000	2-12	-	NZMH4-4-AE1600/1000 265931	S
Earth fault protection									
	50	400	100	200-400	200...400	2-11	-	NZMN3-4-AE400-T 110902	S
		400	60	200-400	125...250	2-11	-	NZMN3-4-AE400/250-T 110903	S
		630	100	315-630	315...630	2-8	-	NZMN3-4-AE630-T 110904	S
		630	60	315-630	200...400	2-8	-	NZMN3-4-AE630/400-T 110905	S
	150	400	100	200-400	200...400	2-11	-	NZMH3-4-AE400-T 110906	S
		400	60	200-400	125...250	2-11	-	NZMH3-4-AE400/250-T 110907	S
		630	100	315-630	315...630	2-8	-	NZMH3-4-AE630-T 110908	S
		630	60	315-630	200...400	2-8	-	NZMH3-4-AE630/400-T 110909	S

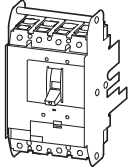
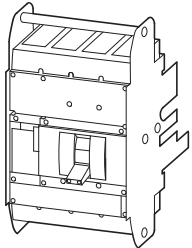
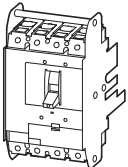
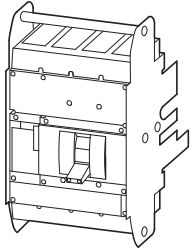
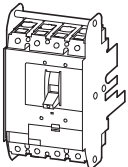
Fixed mounting with box terminals			Withdrawable units			Std. pack	Notes
Part no. Article no.	Price See price list		Part no. Article no.	Price See price list			
			Order base separately				
							B = box terminals S = screw terminals
NZMN3-4-AE630-BT 111658		B		NZMN3-4-AE630-AVE 110875		1 off	For further terminal types see accessories IEC/EN 60947-2 R.m.s. value measurement and "thermal memory" Set value for neutral conductor is same as set value I _n for main pole.
Terminals as accessory				NZMN3-4-AE630/400-AVE 113544			
				Withdrawable units as accessories			
				NZMH3-4-AE630-AVE 110879		1 off	
				NZMH3-4-AE630/400-AVE 113590			
				Withdrawable units as accessories			
Terminals as accessory				NZMN3-4-AE400-T-AVE 113538		1 off	
				NZMN3-4-AE400/250-T-AVE 113539			
				NZMN3-4-AE630-T-AVE 113540			
				NZMN3-4-AE630/400-T-AVE 113541			
				NZMH3-4-AE400-T-AVE 113584			
				NZMH3-4-AE400/250-T-AVE 113585			
				NZMH3-4-AE630-T-AVE 113586			
				NZMH3-4-AE630/400-T-AVE 113587			



Switching capacity 400/415 V 50/60 Hz	Rated current = Rated uninterrupted current		Setting range				Fixed mounting with screw terminals Part no. Article no.	Price See price list
	Phase conductors	Neutral conductor	Overload releases		Short-circuit releases			
			I_r	Phase conductor	Non- delayed	Delayed		
I_{cu}	$I_n = I_u$	$I_r \times \% \text{ of phase conductor}$	I_r	I_r	$I_i = I_n \times \dots$	$I_{sd} = I_r \times \dots$		
kA	A	%	A	A				

Systems protection, cable protection, selectivity, generator protection

Normal switching capacity

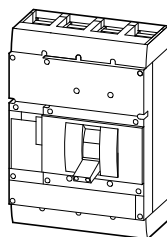
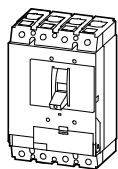
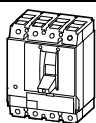

50	Rated current (Phase)	Rated current (Neutral)	Setting range (Overload)	Setting range (Phase)	Short-circuit releases (Non-delayed)	Short-circuit releases (Delayed)	Part no.	Price
	100	100	50-100	50...100	1200 A fixed	2-10	NZMN2-4-VE100 265933	S
	160	100	80-160	80...160	1920 A fixed	2-10	NZMN2-4-VE160 265935	S
	160	60	80-160	50...100	1920 A fixed	2-10	NZMN2-4-VE160/100 265936	S
	250	100	125-250	125...250	3000 A fixed	2-10	NZMN2-4-VE250 265938	S
	250	60	125-250	80...160	3000 A fixed	2-10	NZMN2-4-VE250/160 265939	S
	400	100	200-400	200...400	2-11	2-10	NZMN3-4-VE400 265957	S
	400	60	200-400	125...250	2-11	2-10	NZMN3-4-VE400/250 265958	S
	630	100	315-630	315...630	2-8	1.5-7	NZMN3-4-VE630 265960	S
	630	60	315-630	200...400	2-8	1.5-7	NZMN3-4-VE630/400 265961	S
	800	100	400-800	400...800	2-12	2-10	NZMN4-4-VE800 265975	S
	800	60	400-800	250...500	2-12	2-10	NZMN4-4-VE800/500 265976	S
	1000	100	500-1000	500...1000	2-12	2-10	NZMN4-4-VE1000 265978	S
	1000	60	500-1000	315...630	2-12	2-10	NZMN4-4-VE1000/630 265979	S
	1250	100	630-1250	630...1250	2-12	2-10	NZMN4-4-VE1250 265981	S
	1250	60	630-1250	400...800	2-12	2-10	NZMN4-4-VE1250/800 265982	S
	1600	100	800-1600	800...1600	2-12	2-10	NZMN4-4-VE1600 265984	S
	1600	60	800-1600	500...1000	2-12	2-10	NZMN4-4-VE1600/1000 265985	S



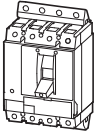
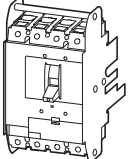
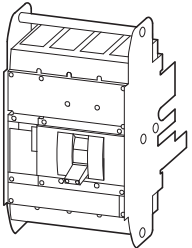

Fixed mounting with box terminals		Plug-in/withdrawable units		Std. pack	Notes		
Part no. Article no.	Price See price list	Part no. Article no.	Price See price list				
		Order base separately					
					B = box terminals S = screw terminals For further terminal types see accessories		
Terminals as accessory		NZMN2-4-VE100-SVE 113275		1 off	IEC/EN 60947-2 Set value for neutral conductor is same as set value I_r for main pole. R.m.s. value measurement and "thermal memory" Adjustable delay setting t_r • 2 – 20 s at 6 x I_r and infinite (without overload release) – NZM...3-4-VE400(630): 2 – 14 s at 6 x I_r and infinite (without overload release) Adjustable delay t_{sd} • Steps: 0, 20, 60, 100, 200, 300, 500, 750, 1000 ms i ² t constant function • NZM2 fixed OFF • NZM3, NZM4 switchable		
		NZMN2-4-VE160-SVE 113277					
		NZMN2-4-VE160/100-SVE 113278					
		NZMN2-4-VE250-SVE 113280					
		NZMN2-4-VE250/160-SVE 113281					
		NZMN3-4-VE400-AVE 110876					
		NZMN3-4-VE400/250-AVE 113546					
		NZMN3-4-VE630-AVE 110877					
		NZMN3-4-VE630/400-AVE 113548					
		Withdrawable units as accessories					
							
							

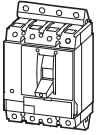
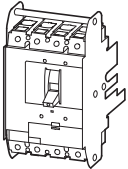

	Switching capacity 400/415 V 50/60 Hz	Rated current = Rated uninterrupted current		Setting range		Short-circuit releases		Fixed mounting with screw terminals Part no. Article no.	Price See price list
		Phase conductors	Neutral conductor	Overload releases		Non- delayed	Delayed		
				I_r	Phase conductor				
	I_{cu} kA	$I_n = I_u$ A	$I_r \times \% \text{ of phaseconductor}$ %	I_r A	I_r A	$I_i = I_n \times \dots$	$I_{sd} = I_r \times \dots$		
Systems protection, cable protection, selectivity, generator protection									
High switching capacity									
	150	100	100	50-100	50...100	1200 A fixed	2-10	NZMH2-4-VE100 265941	S
		160	100	80-160	80...160	1920 A fixed	2-10	NZMH2-4-VE160 265943	S
		160	60	80-160	50...100	1920 A fixed	2-10	NZMH2-4-VE160/100 265944	S
		250	100	125-250	125...250	3000 A fixed	2-10	NZMH2-4-VE250 265946	S
		250	60	125-250	80...160	3000 A fixed	2-10	NZMH2-4-VE250/160 265947	S
		400	100	200-400	200...400	2-11	2-10	NZMH3-4-VE400 265963	S
		400	60	200-400	125...250	2-11	2-10	NZMH3-4-VE400/250 265964	S
		630	100	315-630	315...630	2-8	1.5-7	NZMH3-4-VE630 265966	S
		630	60	315-630	200...400	2-8	1.5-7	NZMH3-4-VE630/400 265967	S
			85	800	100	400-800	400...800	2-12	2-10
800	60			400-800	250...500	2-12	2-10	NZMH4-4-VE800/500 265988	S
1000	100			500-1000	500...1000	2-12	2-10	NZMH4-4-VE1000 265990	S
1000	60			500-1000	315...630	2-12	2-10	NZMH4-4-VE1000/630 265991	S
1250	100			630-1250	630...1250	2-12	2-10	NZMH4-4-VE1250 265993	S
1250	60			630-1250	400...800	2-12	2-10	NZMH4-4-VE1250/800 265994	S
1600	100			800-1600	800...1600	2-12	2-10	NZMH4-4-VE1600 265996	S
1600	60			800-1600	500...1000	2-12	2-10	NZMH4-4-VE1600/1000 265997	S
Earth fault protection									
	50	400	100	200-400	200...400	2-11	2-10	—	—
		630	100	315-630	315...630	2-8	1.5-7	—	—
	150	400	100	200-400	200...400	2-11	2-10	—	—
		630	100	315-630	315...630	2-8	1.5-7	—	—

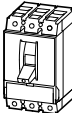
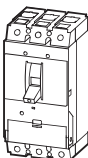

Fixed mounting with box terminals		Plug-in/withdrawable units		Std. pack	Notes
Part no. Article no.	Price See price list	Part no. Article no.	Price See price list		
		Order base separately			
					B = box terminals S = screw terminals For further terminal types see accessories
Terminals as accessory		NZMH2-4-VE100-SVE 113388		1 off	IEC/EN 60947-2 Set value for neutral conductor is same as set value I_r for main pole. R.m.s. value measurement and "thermal memory" Adjustable delay setting t_r • 2 – 20 s at $6 \times I_r$ and infinite (without overload release) – NZM...3-4-VE400(630): 2 – 14 s at $6 \times I_r$ and infinite (without overload release) Adjustable delay t_{sd} • Steps: 0, 20, 60, 100, 200, 300, 500, 750, 1000 ms i^2t constant function • NZM2 fixed OFF • NZM3, NZM4 switchable
		NZMH2-4-VE160-SVE 113390			
		NZMH2-4-VE160/100-SVE 113391			
		NZMH2-4-VE250-SVE 113393			
		NZMH2-4-VE250/160-SVE 113394			
		NZMH3-4-VE400-AVE 110880			
		NZMH3-4-VE400/250-AVE 113592			
		NZMH3-4-VE630-AVE 110881			
		NZMH3-4-VE630/400-AVE 113594			
		NZMN3-4-VE400-T-AVE 119902		1 off	
		NZMN3-4-VE630-T-AVE 119903			
		NZMH3-4-VE400-T-AVE 119900			
		NZMH3-4-VE630-T-AVE 119901			

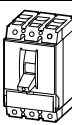
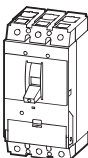
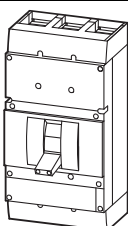

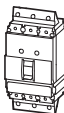
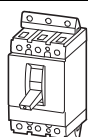
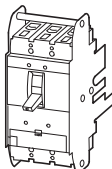
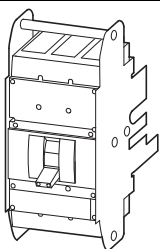
	Rated current = Rated uninterrupted current $I_n = I_u$ A	Short-circuit protection, max. fuse gL-characteristic A gL	Fixed mounting with screw terminals Part no. Article no.	Price See price list	Fixed mounting with box terminals Part no. Article no.	Price See price list
Switch-disconnectors						
2 switch positions I, 0						
	63	125	Screw terminals as accessories		PN1-63 259140	B
	100	125			PN1-100 259141	B
	125	125			PN1-125 259142	B
	160	160			PN1-160 281235	B
	160	250	PN2-160 266005	S	PN2-160-BT 110308	B
	200	250	PN2-200 266006	S	PN2-200-BT 110309	B
	250	250	PN2-250 266007	S	PN2-250-BT 110310	B
	400	630	PN3-400 266017	S	PN3-400-BT 110314	B
	630	630	PN3-630 266018	S	PN3-630-BT 110315	B
3 switch positions I, +, 0 Can be remotely operated with shunt release XU/XA, remote operator XR, Can be equipped with trip-indicating auxiliary contact M22-K..						
	63	125	Screw terminals as accessories		N1-63 259143	B
	100	125			N1-100 259144	B
	125	125			N1-125 259145	B
	160	160			N1-160 281236	B
	160	250	N2-160 266008	S	N2-160-BT 110311	B
	200	250	N2-200 266009	S	N2-200-BT 110312	B
	250	250	N2-250 266010	S	N2-250-BT 110313	B
	400	630	N3-400 266019	S	N3-400-BT 110316	B
	630	630	N3-630 266020	S	N3-630-BT 110317	B
	800	1600	N4-800 266025	S	Terminals as acces- sory	
	1000	1600	N4-1000 266026	S		
	1250	1600	N4-1250 266027	S		
	1600	1600	N4-1600 266028	S		

Plug-in/withdrawable units		Std. pack	Notes
Part no. Article no.	Price See price list		
			B = box terminals S = screw terminals For further terminal types see accessories
-	-	1 off	IEC/EN 60947-3 Main switch characteristics including positive operation to IEC/EN 60204, VDE 0113 Isolating characteristics to IEC/EN 60947-3, VDE 0660 Contact protection to VDE 0160 part 100
	N1-63-SVE 113729	1 off	
	N1-100-SVE 113730		
	N1-125-SVE 113731		
	-		
	N2-160-SVE 113733	1 off	
	N2-200-SVE 113734		
	N2-250-SVE 113735		
	N3-400-AVE 110768	1 off	
	N3-630-AVE 110769		
	Withdrawable units as accessories		

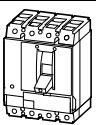
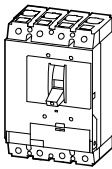

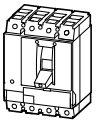
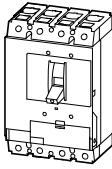
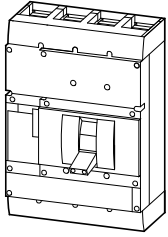
	Rated current = Rated uninterrupted current $I_n = I_u$ A	Short-circuit protection, max. fuse gL-characteristic A gL	Fixed mounting with screw terminals Part no. Article no.	Price See price list	Fixed mounting with box terminals Part no. Article no.	Price See price list
Switch-disconnectors						
2 switch positions I, 0						
	63	125	Screw terminals as accessories		PN1-4-63 265999	B
	100	125			PN1-4-100 266000	B
	125	125			PN1-4-125 266001	B
	160	160			PN1-4-160 281253	B
	160	250	PN2-4-160 266011	S	PN2-4-160-BT 118880	B
	200	250	PN2-4-200 266012	S	PN2-4-200-BT 118881	B
	250	250	PN2-4-250 266013	S	PN2-4-250-BT 118882	B
	400	630	PN3-4-400 266021	S	PN3-4-400-BT 111653	B
	630	630	PN3-4-630 266022	S	PN3-4-630-BT 111654	B
3 switch positions I, +, 0 Can be remotely operated with shunt release XU/XA, remote operator XR, Can be equipped with trip-indicating auxiliary contact M22-K..						
	63	125	Screw terminals as accessories		N1-4-63 266002	B
	100	125			N1-4-100 266003	B
	125	125			N1-4-125 266004	B
	160	160			N1-4-160 281254	B
	160	250	N2-4-160 266014	S	N2-4-160-BT 118883	B
	200	250	N2-4-200 266015	S	N2-4-200-BT 118884	B
	250	250	N2-4-250 266016	S	N2-4-250-BT 118885	B
	400	630	N3-4-400 266023	S	N3-4-400-BT 111651	B
	630	630	N3-4-630 266024	S	N3-4-630-BT 111652	B
	800	1600	N4-4-800 266029	S	Terminals as accessory	
	1000	1600	N4-4-1000 266030	S		
	1250	1600	N4-4-1250 266031	S		
	1600	1600	N4-4-1600 266032	S		

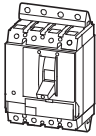
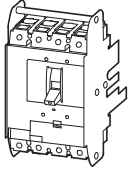
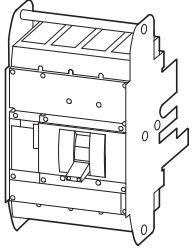
Plug-in units		Price See price list	Std. pack	Notes
Part no. Article no.	Order base separately			
<p>B = box terminals S = screw terminals</p> <p>For further terminal types see accessories</p>				
-	-	-	1 off	IEC/EN 60947-3
-	-	-	-	Main switch characteristics including positive operation to IEC/EN 60204, VDE 0113
-	-	-	-	Isolating characteristics to IEC/EN 60947-3, VDE 0660
-	-	-	-	Contact protection to VDE 0160 part 100
-	-	-	-	
-	-	-	-	
-	-	-	-	
-	-	-	1 off	
-	-	-	-	
-	-	-	-	
	N2-4-160-SVE 113736	-	-	
	N2-4-200-SVE 113737	-	-	
	N2-4-250-SVE 113738	-	-	
	N3-4-400-AVE 110872	-	-	
	N3-4-630-AVE 110873	-	-	
	Withdrawable units as accessories	-	-	



17/46 Circuit-breakers, switch-disconnectors

Technical overview for 1000 V

NZM...-S1, N...-S1

With main switch characteristics to IEC/EN 60204 and isolating characteristics to IEC/EN 60947, VDE 660

Circuit-breakers for 1000 V AC, 3 pole

Switch-disconnectors for 1000 V DC, 2 pole
Without overload and short-circuit release

		System and cable protection			Selectivity protection		Motor protection				
Switching capacity											
1000 V	kA/p.f.	I_{cu}	10/0.5	15/0.5	20/0.3	10/0.5	20/0.3	15/0.5	20/0.3		
		I_{cs}	3/0.5	10/0.5	15/0.3	3/0.5	15/0.3	10/0.5	15/0.3		
Rated uninterrupted current I_u = Rated current I_n		I_u	I_u	I_u	I_u	I_u	I_u	I_u	I_u	I_u	I_u
Ambient air temperature at 100% I_u min./max. -25/+50 °C N... S1-DC max. +70 °C		A	A	A	A	A	A	A	A	A	A
		NZMH2-A...-S1	NZMH3-AE...-S1	NZMH4-AE...-S1	NZMH2-VE...-S1	NZMH4-VE...-S1	NZMH3-ME...-S1	NZMH4-ME...-S1	N2-...-S1-DC	N3-...-S1-DC	N4-...-S1-DC
		20	250	630	100	630	220	550	160	320	800
		25	400	800	160	800	350	875	200	400	1000
		32	630	1000	250	1000	450	1400		500	1250
		40		1250		1250					1400
		50		1600		1600					
		63									
		80									
		100									
		125									
		160									
		200									
		250									
		300									
Rated short-time withstand current I_{cw} (0.1s current t_{rms})		kA							3	6	25

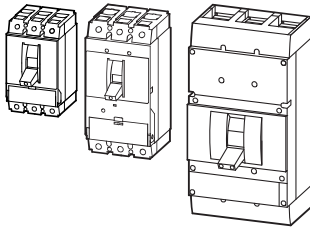

HPL17047EN

	Switching capacity 1000 V 50/60 Hz	Rated current = Rated uninterrupted current	Setting range		Fixed mounting Part no. Article no.	Price See price list	Std. pack	
			Overload releases	Short-circuit releases				
				Non-delayed				Delayed
	I_{cu} kA	$I_n = I_u$ A	I_r A	$I_i = I_n \times \dots$	$I_{sd} = I_r \times \dots$			
System and cable protection								
Thermomagnetic releases								
	10	20	15-20	350 A fixed	–	NZMH2-A20-S1 290355	S	1 off
		25	20-25	350 A fixed	–	NZMH2-A25-S1 290356	S	
		32	25-32	350 A fixed	–	NZMH2-A32-S1 290357	S	
		40	32-40	8-10	–	NZMH2-A40-S1 290358	S	
		50	40-50	6-10	–	NZMH2-A50-S1 290359	S	
		63	50-63	6-10	–	NZMH2-A63-S1 290360	S	
		80	63-80	6-10	–	NZMH2-A80-S1 290361	S	
		100	80-100	6-10	–	NZMH2-A100-S1 290362	S	
		125	100-125	6-10	–	NZMH2-A125-S1 290363	S	
		160	125-160	6-10	–	NZMH2-A160-S1 290364	S	
		200	160-200	6-10	–	NZMH2-A200-S1 290365	S	
250	200-250	6-10	–	NZMH2-A250-S1 290366	S			
300	240-300	6-10	–	NZMH2-A300-S1 107577	S			
Electronic releases								
R.m.s. value measurement and "thermal memory"								
	15	250	125-250	2-11	–	NZMH3-AE250-S1 119361	S	1 off
		400	200-400	2-11	–	NZMH3-AE400-S1 119362	S	
		630	315-630	2-8	–	NZMH3-AE630-S1 119363	S	
	20	630	315-630	2-12	–	NZMH4-AE630-S1 290370	S	
		800	400-800	2-12	–	NZMH4-AE800-S1 290371	S	
		1000	500-1000	2-12	–	NZMH4-AE1000-S1 290372	S	
		1250	630-1250	2-12	–	NZMH4-AE1250-S1 290373	S	
		1600	800-1600	2-12	–	NZMH4-AE1600-S1 290374	S	



Notes

B = box terminals
S = screw terminals

IEC/EN 60947-2

Terminal type:
NZM2: Cover NZM2-XKSA required
NZM3: Cover NZM3-XKSA required
NZM4: Isolated bar connection (screw terminal NZM4-XKS)



Switching capacity 1000 V 50/60 Hz	Rated current = Rated uninterrupted current	Setting range		Short-circuit releases		Fixed mounting Part no. Article no.	Price See price list	Std. pack
		Overload releases	Non-delayed	Delayed				
				I_r A	$I_i = I_n \times \dots$			
I_{cu} kA	$I_n = I_u$ A							

Systems protection, cable protection, selectivity, generator protection

- IEC/EN 60947-2
R.m.s. value measurement and "thermal memory"
Adjustable delay setting t_r
• 2 – 20 s at 6 x I_r and infinite (without overload release)
Adjustable delay t_{sd}
• Steps: 0, 20, 60, 100, 200, 300, 500, 750, 1000 ms
 i^2t constant function
• NZM2 fixed OFF
• NZM3, NZM4 switchable

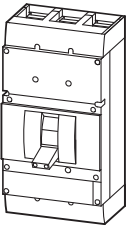
	10	100	50-100	1200 A fixed	2-10	NZMH2-VE100-S1 100777	S	1 off
		160	80-160	1920 A fixed	2-10	NZMH2-VE160-S1 100778	S	
		250	125-250	3000 A fixed	2-10	NZMH2-VE250-S1 100779	S	
		400	200-400	2-11	2-10	NZMH3-VE400-S1 119367	S	
		630	315-630	2-8	1.5-7	NZMH3-VE630-S1 119368	S	
	20	630	315-630	2-12	2-10	NZMH4-VE630-S1 290375	S	
		800	400-800	2-12	2-10	NZMH4-VE800-S1 290376	S	
		1000	500-1000	2-12	2-10	NZMH4-VE1000-S1 290377	S	
		1250	630-1250	2-12	2-10	NZMH4-VE1250-S1 290378	S	
		1600	800-1600	2-12	2-10	NZMH4-VE1600-S1 290379	S	

Motor protection

- IEC/EN 60947-4-1, IEC/EN 60947-2
Phase-failure sensitivity
R.m.s. value measurement and "thermal memory"
Adjustable delay setting t_r
• 2 – 20 s at 6 x I_r and infinite (without overload release)

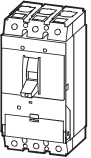
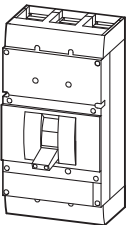
	15	220	110-220	2-14	–	NZMH3-ME220-S1 119364	S	1 off
		350	175-350	2-14	–	NZMH3-ME350-S1 119365	S	
		450	225-450	2-12	–	NZMH3-ME450-S1 119366	S	
	20	550	275-550	2-14	–	NZMH4-ME550-S1 290383	S	
		875	438-875	2-14	–	NZMH4-ME875-S1 290384	S	
		1400	700-1400	2-14	–	NZMH4-ME1400-S1 290385	S	



Notes

B = box terminals
S = screw terminals

Terminal type:
NZM2: Cover NZM2-XKSA required
NZM3: Cover NZM3-XKSA required
NZM4: Isolated bus connection (screw terminal NZM4-XKS)

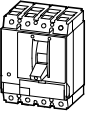
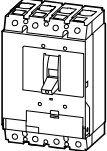
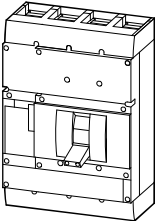
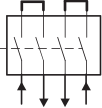
HPL17049EN

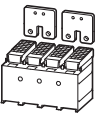
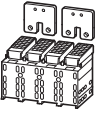
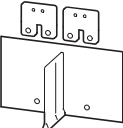
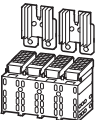
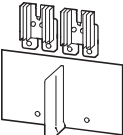
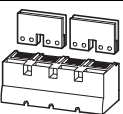
	Rated current = Rated uninterrupted current $I_n = I_u$ A	Short-circuit protection, max. fuse gR- characteristic A gR	Fixed mounting Part no. Article no.	Price See price list	Std. pack	Notes
Switch-disconnectors for 1000 V DC						
	160	200	N2-4-160-S1-DC 127732		1 off	S IEC/EN 60947-3
	200	200	N2-4-200-S1-DC 127733			S Main switch characteristics including positive operation to IEC/EN 60204, VDE 0113. Isolating characteristics to IEC/EN 60947, VDE 0660. Protection against electric shock to VDE 0160 part 100. Switch-disconnectors N can, in addition, be combined with shunt releases NZM...-XU, NZM...-XA and auxiliary contacts as well as with remote operator NZM...-XR...
	320	500	N3-4-320-S1-DC 127734			S
	400	500	N3-4-400-S1-DC 142267			S
	500	500	N3-4-500-S1-DC 142268			S
	800	1600	N4-4-800-S1-DC 119890			S
	1000	1600	N4-4-1000-S1-DC 119891			S
	1250	1600	N4-4-1250-S1-DC 119886			S
	1400	1400	N4-4-1400-S1-DC 119887			S
						<p>Connection types: For 2 pole switching, series connection of two poles each is required. See jumper kits under accessories</p>  <p>Terminals as accessory Switch can not be combined with plug-in/withdrawable units and/or connection on rear.</p>

	Rated operational current I_n A	For use with	Number of poles	Degree of protection	Part no. Article no.	Price See price list	Std. pack
Jumper kits							
Model contains parts for upper switch side for 4 pole switches N...-S1-DC that are used as 2 pole switches for DC. The jumpers each connect two current paths in series. Incomer and outgoing at bottom or top, freely selectable. ≥ 1250 A: For 65 °C ambient air temperature connection at bottom through module plates NZM4-4-XKM2S-1600.							
	Jumper kit with cover	200 at 65 °C 160 at 70 °C	N2-4-...S1-DC	4 pole/ 2 pole	IP2X	NZM2-4-XKV2P 131730	1 off
	Terminal jumpers with cover	400 at 70 °C	N3-320(400)-S1-DC	4 pole/ 2 pole	IP2X	NZM3-4-XKV2P 131731	
	Jumper kit with insulating plates	500 at 50 °C 400 at 70 °C	N3-400(500)-S1-DC	4 pole/ 2 pole	IP00	NZM3-4-XKV12P 142269	
	Jumper kit with cover and heat sink	400 at 70 °C 500 at 55 °C 500 at 40 °C	N3-400(500)-S1-DC	4 pole/ 2 pole	IP1X IP2X	NZM3-4-XKV2P-K 142271	
	Jumper kit with insulating plates and heat sinks	500 at 65 °C	N3-500-S1-DC	4 pole/ 2 pole	IP00	NZM3-4-XKV12P-K 142270	
	Jumper kit with cover	1400 at 40 °C 1250 at 65 °C	N4-4-...S1-DC	4 pole/ 2 pole	IP2X	NZM4-4-XKV2P 119888	
	Jumper kit with heat sink	1400 at 65 °C	N4-4-1400-S1-DC	4 pole/ 2 pole	IP00	NZM4-4-XKV2P-1400 119905	

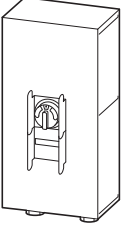
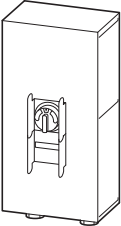
	Number of conductors	Rated current = Rated uninterrupted current $I_n = I_u$ A	Short-circuit protection, max. fuse gL-characteristic A gL	Fixed mounting Part no. Article no.	Price See price list	Std. pack
Switch-disconnectors for ATEX type						
2 switch positions I, 0						
	3 pole	125	125	PN1-125/HIV/DA-SVD-SW/ATEX22 119386		1 off
		160	160	PN1-160/HIV/DA-SVD-SW/ATEX22 119387		
		200	250	PN2-200/HIV/DA-SVD-SW/ATEX22 119388		
		240	250	PN2-250/HIV/DA-SVD-SW/ATEX22 119389		
		400	630	PN3-400/HIV/DA-SVD-SW/ATEX22 119410		
		630	630	PN3-630/HIV/DA-SVD-SW/ATEX22 119411		
		6 pole	160	160	2PN1-160/HIV/DA-SVD-SW/ATEX22 119418	
6 pole	250	250	2PN2-250/HIV/DA-SVD-SW/ATEX22 119419			
ATEX switches for EMC type						
	3 pole	125	125	PN1-125/HIV/DA-SVD-SW/EMV/ATEX22 119412		
		160	160	PN1-160/HIV/DA-SVD-SW/EMV/ATEX22 119413		
		200	250	PN2-200/HIV/DA-SVD-SW/EMV/ATEX22 119414		
		240	250	PN2-250/HIV/DA-SVD-SW/EMV/ATEX22 119415		
		400	630	PN3-400/HIV/DA-SVD-SW/EMV/ATEX22 119416		
		630	630	PN3-630/HIV/DA-SVD-SW/EMV/ATEX22 119417		

Notes

Main switch characteristics including positive operation to IEC/EN 60204, VDE 0113.

Isolating characteristics to IEC/EN 60947-3, VDE 0660.

Protection against electric shock to VDE 0160 part 100.

ATEX = Atmosphères explosibles = explosive atmospheres

Eaton supplies switch-disconnectors PN1, PN2 and PN3 for a current range of up to 630 A as complete device according to ATEX Directive 94/9 EG (binding as of 06/2003).

The switches are approved for device group II, the application "everything, except for mining" and for category 3 (normal safety).

Switch-disconnectors in surface mounting enclosure with ATEX approval are used in potentially explosive dust-laden areas, such as mills, metal grinding works, wood processing operations, cement works, the aluminum industry, the foodstuffs industry, grain storage and processing plants, agriculture, and in the pharmaceuticals industry.

ATEX switches for EMC are suitable for use with screened cables.

For important general flush mounting and application notes, see the included installation instructions AWA1230-2480, which you can also download from our homepage www.moeller.net.





Circuit-breakers

UL/CSA approved to UL 489, CSA-C22.2 No. 5-09
as well as IEC/EN 60947

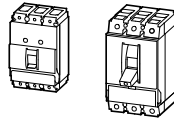

With main switch characteristics to IEC/EN 60204 and isolating
characteristics to IEC/EN 60947, VDE 0660

Rated uninterrupted current I_u = Rated current I_n
Adjustable overload releases I_r
Adjustable short-circuit releases I_s
Delayed short-circuit releases I_{sd}

Thermomagnetic releases

Overload release

Fixed		Adjustable		None		
I_u	A	I_u	A	I_r	I_u	
NZM1		NZM2	NZM1	NZM2	NZM1	NZM2

			15-125		15-250	20-125	20-250	0.8-1 x I_n	1.2-100	1.6-250
Basic switching capacity¹⁾			NZMB1-...-NA		NZMB2-...-NA					
NEMA Test Procedure	240 V 60 Hz	sym. rms kA	35		35					
SCCR	480 V 60 Hz	sym. rms kA	25 ²⁾		25					
	600 V 60 Hz	sym. rms kA	—		18 ⁴⁾					
IEC/EN 60947	400/415 V	kA/p.f.	25	0.25	25	0.25				
	440 V	kA/p.f.	25	0.25	25	0.25				
Normal switching capacity¹⁾			NZMN1-...-NA		NZMN2-...-NA					
NEMA Test Procedure	240 V 60 Hz	sym. rms kA	85		85					
SCCR	480 V 60 Hz	sym. rms kA	35 ²⁾		35					
	600 V 60 Hz	sym. rms kA	—		25 ⁴⁾					
IEC/EN 60947	400/415 V	kA/p.f.	50	0.25	50	0.25				
	440 V	kA/p.f.	35	0.25	35	0.25				
	525 V	kA/p.f.	20	0.30	25	0.25				
	690 V	kA/p.f.	10	0.50	20	0.30				
High switching capacity¹⁾					NZMH2-...-NA					
NEMA Test Procedure	240 V 60 Hz	sym. rms kA			150					
SCCR	480 V 60 Hz	sym. rms kA			100					
	600 V 60 Hz	sym. rms kA			65 ³⁾⁴⁾					
IEC/EN 60947	400/415 V	kA/p.f.			150	0.20				
	440 V	kA/p.f.			130	0.20				
	525 V	kA/p.f.			50	0.25				
	690 V	kA/p.f.			20	0.30				

Notes

- ¹⁾ Switches correspond with both UL/CSA and IEC regulations
IEC switching performance values shown on type label. → Technical data
²⁾ For NZM...1-...-NA 480V/277V
³⁾ For NZMH2 > 125 A: 50 kA
⁴⁾ For NZM...2: 600V/347 V

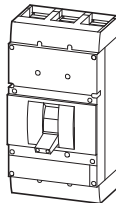
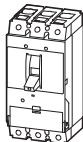
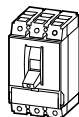

Electronic releases

Overload release

Fixed	Adjustable		None	Fixed	Adjustable		None
I_u	I_u	I_r	I_u	I_u	I_u	I_r	I_u
A	A	A	A	A	A	A	A

Short-circuit releases

System protection		Motor protection
I_{sd}	I_i	I_i
A	A	A

150-250	100-250	0.5 - 1 x I_n	90-220	250-600	250-600	0.5 - 1 x I_n	220-450	600-1200	800-1200	0.5 - 1 x I_n	2-10 x I_r	2-12 x I_n	2-14 x I_n
---------	---------	-----------------	--------	---------	---------	-----------------	---------	----------	----------	-----------------	--------------	--------------	--------------

NZMN2-...E...-NA			NZMN3-...E...-NA			NZMN4-...E...-NA		
85			85			85		
35			42			42		
25 ⁴⁾			35			35		
50	0.25		50	0.25		50	0.25	
35	0.25		35	0.25		35	0.25	
25	0.25		25	0.25		25	0.25	
20	0.30		20	0.30		20	0.30	

NZMH2-...E...-NA			NZMH3-...E...-NA			NZMH4-...E...-NA		
150			150			125		
100			100			85		
50 ⁴⁾			50			50		
150	0.20		150	0.20		85	0.20	
130	0.20		130	0.20		85	0.20	
50	0.25		65	0.25		65	0.25	
20	0.30		35	0.25		50	0.25	

The approved switches are suitable for world-wide use. The UL and CSA certificates can be found at www.ul.com and www.csa.com
 UL certificates: File No.:E 31593 (NZM1-4), E 148671 (N(S)1-4)
 CSA certificates: File No.165628 (NZM1-4)

Molded case switch
UL/CSA approved to UL 489, CSA 22.2 No. 5-09
as well as IEC/EN 60947-2 Annex L

With main switch characteristics to IEC/EN 60204, VDE 0113
 Isolating characteristics to IEC/EN 60947

Without overcurrent protection

With short-circuit release

Rated uninterrupted current $I_u = I_n$

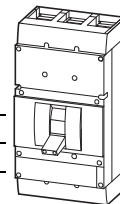
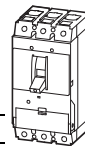

63
100
125

160
200
250

400
600

800
1000
1200

Switching capacity		NS1-...-NA	NS2-...-NA	NS3-...-NA	NS4-...-NA
according to UL 489, CSA 22.2	240 V	85	150	150	85
SCCR	480 V	35 ¹⁾	100	100	65
	600 V	—	50 ⁴⁾	50	42
	IEC/EN 60947	400/415 V	50	150	150
	440 V	35	130	130	65
	525 V	20	50	65	40
	690	10	20	35	35

Notes

¹⁾ For NS1-...-NA: 480Y/277V

⁴⁾ For NZM...2: 600Y/347 V

Switching capacity				Rated current = Rated uninterrupted current	Setting range		Fixed mounting	Part no. Article no.	Price See price list
SCCR 480Y/ 277 V 60 Hz	SCCR 480 V 60 Hz	SCCR 600Y/ 347 V 60 Hz	SCCR 600 V 60 Hz		Overload releases	Short-circuit releases			
I_{cu} kA	I_{cu} kA	I_{cu} kA	I_{cu} kA	$I_n = I_u$ A	Fixed I_r A	Non-delayed $I_i = I_n \times \dots$			

System and cable protection

Fixed overload releases I_r

Basic switching capacity



Basic switching capacity	25								
	25	-	-	-	20	20	350 A fixed	Screw terminals as accessories	-
					25	25	350 A fixed		-
					30	30	350 A fixed		-
					35	35	Approx. 8-10		-
					40	40	Approx. 8-10		-
					45	45	Approx. 6-10		-
					50	50	Approx. 6-10		-
					60	60	Approx. 6-10		-
					70	70	Approx. 6-10		-
					80	80	Approx. 6-10		-
					90	90	Approx. 6-10		-
					100	100	Approx. 6-10		-
					110	110	Approx. 6-10		-
					125	125	Approx. 6-10		-

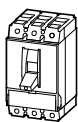

Basic switching capacity	25	25	18						
	25	25	18	-	15	15	350 A fixed	NZMB2-AF15-NA 269142	S
				-	20	20	350 A fixed	NZMB2-AF20-NA 269143	S
				-	25	25	350 A fixed	NZMB2-AF25-NA 269144	S
				-	30	30	350 A fixed	NZMB2-AF30-NA 269145	S
				-	35	35	Approx. 8-10	NZMB2-AF35-NA 269146	S
				-	40	40	Approx. 8-10	NZMB2-AF40-NA 269147	S
				-	45	45	Approx. 6-10	NZMB2-AF45-NA 269148	S
				-	50	50	Approx. 6-10	NZMB2-AF50-NA 269149	S
				-	60	60	Approx. 6-10	NZMB2-AF60-NA 269160	S
				-	70	70	Approx. 6-10	NZMB2-AF70-NA 269161	S
				-	80	80	Approx. 6-10	NZMB2-AF80-NA 269162	S
				-	90	90	Approx. 6-10	NZMB2-AF90-NA 269163	S
				-	100	100	Approx. 6-10	NZMB2-AF100-NA 269164	S
				-	110	110	Approx. 6-10	NZMB2-AF110-NA 269165	S
				-	125	125	Approx. 6-10	NZMB2-AF125-NA 269166	S
				-	150	150	Approx. 6-10	NZMB2-AF150-NA 269167	S

HPL17055EN

NZM...AF...NA

Fixed mounting with box terminals				Information relevant for export to North America	Notes
Part no. Article no.	Price See price list	Std. pack			
B = box terminals S = screw terminals					
NZMB1-AF20-NA 281554		B	1 off	Product Standards UL 489; CSA-C22.2 No. 5-09; IEC 60947-2; CE marking UL File No. E31593 UL CCN DIVQ CSA File No. 022086 CSA Class No. 1432-01 NA Certification UL Listed, CSA certified Specially designed for NA Yes Suitable for Feeder circuits, branch circuits Current Limiting CB Yes Max. Voltage Rating 480Y/277 V Degree of Protection IEC: IP20; UL/CSA Type: -	Switches correspond with both UL/CSA and IEC regulations. IEC switching performance values shown on type label.
NZMB1-AF25-NA 281555		B			
NZMB1-AF30-NA 281556		B			
NZMB1-AF35-NA 272204		B			
NZMB1-AF40-NA 272205		B			
NZMB1-AF45-NA 272206		B			
NZMB1-AF50-NA 272207		B			
NZMB1-AF60-NA 272208		B			
NZMB1-AF70-NA 272209		B			
NZMB1-AF80-NA 272250		B			
NZMB1-AF90-NA 272251		B			
NZMB1-AF100-NA 272252		B			
NZMB1-AF110-NA 281557		B			
NZMB1-AF125-NA 281558		B			
NZMB2-AF15-BT-NA 107611		B	1 off	Product Standards UL 489; CSA-C22.2 No. 5-09; IEC 60947-2; CE marking UL File No. E31593 UL CCN DIVQ CSA File No. 022086 CSA Class No. 1432-01 NA Certification UL Listed, CSA certified Specially designed for NA Yes Suitable for Feeder circuits, branch circuits Current Limiting CB Yes Max. Voltage Rating 600Y/347 V, 480 V Degree of Protection IEC: IP20; UL/CSA Type: -	
NZMB2-AF20-BT-NA 107612		B			
NZMB2-AF25-BT-NA 107613		B			
NZMB2-AF30-BT-NA 107614		B			
NZMB2-AF35-BT-NA 107615		B			
NZMB2-AF40-BT-NA 107616		B			
NZMB2-AF45-BT-NA 107617		B			
NZMB2-AF50-BT-NA 107618		B			
NZMB2-AF60-BT-NA 107619		B			
NZMB2-AF70-BT-NA 107620		B			
NZMB2-AF80-BT-NA 107621		B			
NZMB2-AF90-BT-NA 107622		B			
NZMB2-AF100-BT-NA 107623		B			
NZMB2-AF110-BT-NA 107624		B			
NZMB2-AF125-BT-NA 107625		B			
NZMB2-AF150-BT-NA 107626		B			



Switching capacity				Rated current = Rated uninterrupted current	Setting range		Part no. Article no.	Price See price list
SCCR 480Y/ 277 V 60 Hz	SCCR 480 V 60 Hz	SCCR 600Y/ 347 V 60 Hz	SCCR 600 V 60 Hz		Overload releases Fixed	Short-circuit releases Non-delayed		
I_{cu} kA	I_{cu} kA	I_{cu} kA	I_{cu} kA	$I_n = I_u$ A	I_r A	$I_i = I_n \times \dots$		

System and cable protection

Fixed overload releases I_r

Basic switching capacity

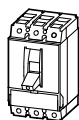

25	25	18	-	175	175	Approx. 6-10	NZMB2-AF175-NA 269168	S
			-	200	200	Approx. 6-10	NZMB2-AF200-NA 269169	S
			-	225	225	Approx. 6-10	NZMB2-AF225-NA 271089	S
			-	250	250	Approx. 6-10	NZMB2-AF250-NA 271100	S

Normal switching capacity







35	-	-	-	20	20	350 A fixed	Screw terminals as accessories		
			-	25	25	350 A fixed			
			-	30	30	350 A fixed			
			-	35	35	Approx. 8-10			
			-	40	40	Approx. 8-10			
			-	45	45	Approx. 6-10			
			-	50	50	Approx. 6-10			
			-	60	60	Approx. 6-10			
			-	70	70	Approx. 6-10			
			-	80	80	Approx. 6-10			
			-	90	90	Approx. 6-10			
			-	100	100	Approx. 6-10			
			-	110	110	Approx. 6-10			
			-	125	125	Approx. 6-10			





35	35	25	-	15	15	350 A fixed	NZMN2-AF15-NA 269170	S
			-	20	20	350 A fixed	NZMN2-AF20-NA 269171	S
			-	25	25	350 A fixed	NZMN2-AF25-NA 269172	S
			-	30	30	350 A fixed	NZMN2-AF30-NA 269173	S
			-	35	35	Approx. 8-10	NZMN2-AF35-NA 269174	S
			-	40	40	Approx. 8-10	NZMN2-AF40-NA 269175	S
			-	45	45	Approx. 6-10	NZMN2-AF45-NA 269176	S
			-	50	50	Approx. 6-10	NZMN2-AF50-NA 269177	S
			-	60	60	Approx. 6-10	NZMN2-AF60-NA 269178	S
			-	70	70	Approx. 6-10	NZMN2-AF70-NA 269179	S



HPL17057EN

NZM...AF...NA



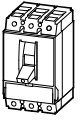
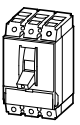

Fixed mounting with box terminals					
Part no. Article no.	Price See price list	Std. pack	Information relevant for export to North America 		Notes
B = box terminals S = screw terminals					
NZMB2-AF175-BT-NA 107627		B	1 off 	Product Standards UL 489; CSA-C22.2 No. 5-09; IEC 60947-2; CE marking	Switches correspond with both UL/CSA and IEC regulations. IEC switching performance values shown on type label.
NZMB2-AF200-BT-NA 107628		B		UL File No. E31593	
NZMB2-AF225-BT-NA 107629		B		UL CCN DIVQ	
NZMB2-AF250-BT-NA 107630		B		CSA File No. 022086 CSA Class No. 1432-01 NA Certification UL Listed, CSA certified Specially designed for NA Yes Suitable for Feeder circuits, branch circuits Current Limiting CB Yes Max. Voltage Rating 600Y/347 V, 480 V Degree of Protection IEC: IP20; UL/CSA Type: -	
NZMN1-AF20-NA 281565		B	1 off 	Product Standards UL 489; CSA-C22.2 No. 5-09; IEC 60947-2; CE marking	
NZMN1-AF25-NA 281566		B		UL File No. E31593	
NZMN1-AF30-NA 281567		B		UL CCN DIVQ	
NZMN1-AF35-NA 274220		B		CSA File No. 022086 CSA Class No. 1432-01 NA Certification UL Listed, CSA certified Specially designed for NA Yes Suitable for Feeder circuits, branch circuits Current Limiting CB Yes Max. Voltage Rating 480Y/277 V Degree of Protection IEC: IP20; UL/CSA Type: -	
NZMN1-AF40-NA 274223		B			
NZMN1-AF45-NA 274230		B			
NZMN1-AF50-NA 274231		B			
NZMN1-AF60-NA 274232		B			
NZMN1-AF70-NA 274233		B			
NZMN1-AF80-NA 274234		B			
NZMN1-AF90-NA 274235		B			
NZMN1-AF100-NA 274236		B			
NZMN1-AF110-NA 281568		B			
NZMN1-AF125-NA 281569		B			
NZMN2-AF15-BT-NA 107631		B	1 off 	Product Standards UL 489; CSA-C22.2 No. 5-09; IEC 60947-2; CE marking	
NZMN2-AF20-BT-NA 107632		B		UL File No. E31593	
NZMN2-AF25-BT-NA 107633		B		UL CCN DIVQ	
NZMN2-AF30-BT-NA 107634		B		CSA File No. 022086 CSA Class No. 1432-01 NA Certification UL Listed, CSA certified Specially designed for NA Yes Suitable for Feeder circuits, branch circuits Current Limiting CB Yes Max. Voltage Rating 600Y/347 V, 480 V Degree of Protection IEC: IP20; UL/CSA Type: -	
NZMN2-AF35-BT-NA 107635		B			
NZMN2-AF40-BT-NA 107636		B			
NZMN2-AF45-BT-NA 107637		B			
NZMN2-AF50-BT-NA 107638		B			
NZMN2-AF60-BT-NA 107639		B			
NZMN2-AF70-BT-NA 107640		B			





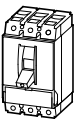

								Fixed mounting	
Switching capacity				Rated current = Rated uninterrupted current	Setting range		Part no. Article no.	Price See price list	
SCCR 480Y/ 277 V 60 Hz	SCCR 480 V 60 Hz	SCCR 600Y/ 347 V 60 Hz	SCCR 600 V 60 Hz		Overload releases Fixed	Short-circuit releases Non-delayed			
I_{cu} kA	I_{cu} kA	I_{cu} kA	I_{cu} kA		$I_n = I_u$ A	$I_i = I_n \times \dots$			
									
System and cable protection									
Fixed overload releases I_r									
Normal switching capacity									
	35	35	25	-	80	80	Approx. 6-10	NZMN2-AF80-NA 269180	S
				-	90	90	Approx. 6-10	NZMN2-AF90-NA 269181	S
				-	100	100	Approx. 6-10	NZMN2-AF100-NA 269182	S
				-	110	110	Approx. 6-10	NZMN2-AF110-NA 269183	S
				-	125	125	Approx. 6-10	NZMN2-AF125-NA 269184	S
				-	150	150	Approx. 6-10	NZMN2-AF150-NA 269185	S
				-	175	175	Approx. 6-10	NZMN2-AF175-NA 269186	S
				-	200	200	Approx. 6-10	NZMN2-AF200-NA 269187	S
				-	225	225	Approx. 6-10	NZMN2-AF225-NA 271101	S
				-	250	250	Approx. 6-10	NZMN2-AF250-NA 271102	S
High switching capacity									
	150	150	65	-	15	15	350 A fixed	NZMH2-AF15-NA 269188	S
				-	20	20	350 A fixed	NZMH2-AF20-NA 269189	S
				-	25	25	350 A fixed	NZMH2-AF25-NA 269190	S
				-	30	30	350 A fixed	NZMH2-AF30-NA 269191	S
				-	35	35	Approx. 8-10	NZMH2-AF35-NA 269192	S
				-	40	40	Approx. 8-10	NZMH2-AF40-NA 269193	S
				-	45	45	Approx. 6-10	NZMH2-AF45-NA 269194	S
				-	50	50	Approx. 6-10	NZMH2-AF50-NA 269195	S
				-	60	60	Approx. 6-10	NZMH2-AF60-NA 269196	S
				-	70	70	Approx. 6-10	NZMH2-AF70-NA 269197	S
				-	80	80	Approx. 6-10	NZMH2-AF80-NA 269198	S
				-	90	90	Approx. 6-10	NZMH2-AF90-NA 269199	S
				-	100	100	Approx. 6-10	NZMH2-AF100-NA 269200	S
				-	110	110	Approx. 6-10	NZMH2-AF110-NA 269201	S
				-	125	125	Approx. 6-10	NZMH2-AF125-NA 269202	S
				-	150	150	Approx. 6-10	NZMH2-AF150-NA 269203	S
				-	175	175	Approx. 6-10	NZMH2-AF175-NA 269204	S
				-	200	200	Approx. 6-10	NZMH2-AF200-NA 269205	S
				-	225	225	Approx. 6-10	NZMH2-AF225-NA 271103	S
				-	250	250	Approx. 6-10	NZMH2-AF250-NA 271104	S





Fixed mounting with box terminals					
Part no. Article no.	Price See price list	Std. pack	Information relevant for export to North America 		Notes
B = box terminals S = screw terminals					
NZMN2-AF80-BT-NA 107641		B	1 off 	Product Standards UL 489; CSA-C22.2 No. 5-09; IEC 60947-2; CE marking UL File No. E31593 UL CCN DIVQ CSA File No. 022086 CSA Class No. 1432-01 NA Certification UL Listed, CSA certified Specially designed for NA Yes Suitable for Feeder circuits, branch circuits Current Limiting CB Yes Max. Voltage Rating 600Y/347 V, 480 V Degree of Protection IEC: IP20; UL/CSA Type: -	Switches correspond with both UL/CSA and IEC regulations. IEC switching performance values shown on type label.
NZMN2-AF90-BT-NA 107642		B			
NZMN2-AF100-BT-NA 107643		B			
NZMN2-AF110-BT-NA 107644		B			
NZMN2-AF125-BT-NA 107645		B			
NZMN2-AF150-BT-NA 107646		B			
NZMN2-AF175-BT-NA 107647		B			
NZMN2-AF200-BT-NA 107648		B			
NZMN2-AF225-BT-NA 107649		B			
NZMN2-AF250-BT-NA 107650		B			
NZMH2-AF15-BT-NA 107809		B	1 off 	Product Standards UL 489; CSA-C22.2 No. 5-09; IEC 60947-2; CE marking UL File No. E31593 UL CCN DIVQ CSA File No. 022086 CSA Class No. 1432-01 NA Certification UL Listed, CSA certified Specially designed for NA Yes Suitable for Feeder circuits, branch circuits Current Limiting CB Yes Max. Voltage Rating 600Y/347 V, 480 V Degree of Protection IEC: IP20; UL/CSA Type: -	
NZMH2-AF20-BT-NA 107810		B			
NZMH2-AF25-BT-NA 107811		B			
NZMH2-AF30-BT-NA 107812		B			
NZMH2-AF35-BT-NA 107813		B			
NZMH2-AF40-BT-NA 107814		B			
NZMH2-AF45-BT-NA 107815		B			
NZMH2-AF50-BT-NA 107816		B			
NZMH2-AF60-BT-NA 107817		B			
NZMH2-AF70-BT-NA 107818		B			
NZMH2-AF80-BT-NA 107819		B			
NZMH2-AF90-BT-NA 107820		B			
NZMH2-AF100-BT-NA 107821		B			
NZMH2-AF110-BT-NA 107822		B			
NZMH2-AF125-BT-NA 107823		B			
NZMH2-AF150-BT-NA 107824		B			
NZMH2-AF175-BT-NA 107825		B			
NZMH2-AF200-BT-NA 107826		B			
NZMH2-AF225-BT-NA 107827		B			
NZMH2-AF250-BT-NA 107828		B			





								Fixed mounting	
Switching capacity				Rated current = Rated uninterrupted current	Setting range			Part no. Article no.	Price See price list
SCCR 480Y/ 277 V 60 Hz	SCCR 480 V 60 Hz	SCCR 600Y/ 347 V 60 Hz	SCCR 600 V 60 Hz	$I_n = I_u$	Overload releases	Short-circuit releases			
I_{cu} kA	I_{cu} kA	I_{cu} kA	I_{cu} kA	A	I_r A	Non-delayed $I_i = I_n \times \dots$			
									
System and cable protection									
Adjustable overload release I_r									
Basic switching capacity									
	25	-	-	-	20	15-20	350 A fixed	Screw terminals as accessories	
					25	20-25	350 A fixed		
					32	25-32	350 A fixed		
					40	32-40	8-10		
					50	40-50	6-10		
					63	50-63	6-10		
					80	63-80	6-10		
					100	80-100	6-10		
					125	100-125	6-10		
	25	25	18	-	20	15-20	350 A fixed	NZMB2-A20-NA 269206	S
				-	25	20-25	350 A fixed	NZMB2-A25-NA 269207	S
				-	32	25-32	350 A fixed	NZMB2-A32-NA 269208	S
				-	40	32-40	8-10	NZMB2-A40-NA 269209	S
				-	50	40-50	6-10	NZMB2-A50-NA 269210	S
				-	63	50-63	6-10	NZMB2-A63-NA 269211	S
				-	80	63-80	6-10	NZMB2-A80-NA 269212	S
				-	100	80-100	6-10	NZMB2-A100-NA 269213	S
				-	125	100-125	6-10	NZMB2-A125-NA 269214	S
				-	160	125-160	6-10	NZMB2-A160-NA 269215	S
				-	200	160-200	6-10	NZMB2-A200-NA 269216	S
				-	250	200-250	6-10	NZMB2-A250-NA 271105	S
Normal switching capacity									
	35	-	-	-	20	15-20	350 A fixed	Screw terminals as accessories	
					25	20-25	350 A fixed		
					32	25-32	350 A fixed		
					40	32-40	8-10		
					50	40-50	6-10		
					63	50-63	6-10		



Fixed mounting with box terminals	Price See price list	Std. pack	Information relevant for export to North America	Notes	
Part no. Article no.					
B = box terminals S = screw terminals					
NZMB1-A20-NA 281559		B	1 off 	Switches correspond with both UL/CSA and IEC regulations. IEC switching performance values shown on type label.	
NZMB1-A25-NA 281560		B			
NZMB1-A32-NA 281561		B			
NZMB1-A40-NA 272253		B			
NZMB1-A50-NA 272254		B			
NZMB1-A63-NA 272255		B			
NZMB1-A80-NA 272256		B			
NZMB1-A100-NA 272258		B			
NZMB1-A125-NA 281562		B			
NZMB2-A20-BT-NA 107773		B	1 off 		Switches correspond with both UL/CSA and IEC regulations. IEC switching performance values shown on type label.
NZMB2-A25-BT-NA 107774		B			
NZMB2-A32-BT-NA 107775		B			
NZMB2-A40-BT-NA 107776		B			
NZMB2-A50-BT-NA 107777		B			
NZMB2-A63-BT-NA 107778		B			
NZMB2-A80-BT-NA 107779		B			
NZMB2-A100-BT-NA 107780		B			
NZMB2-A125-BT-NA 107781		B			
NZMB2-A160-BT-NA 107782		B			
NZMB2-A200-BT-NA 107783		B			
NZMB2-A250-BT-NA 107784		B			
NZMN1-A20-NA 281570		B	1 off 	Switches correspond with both UL/CSA and IEC regulations. IEC switching performance values shown on type label.	
NZMN1-A25-NA 281571		B			
NZMN1-A32-NA 281572		B			
NZMN1-A40-NA 274237		B			
NZMN1-A50-NA 274239		B			
NZMN1-A63-NA 274240		B			



Switching capacity				Rated current = Rated uninterrupted current	Setting range		Fixed mounting	Part no. Article no.	Price See price list
SCCR 480V/ 277 V 60 Hz	SCCR 480 V 60 Hz	SCCR 600V/ 347 V 60 Hz	SCCR 600 V 60 Hz		Overload releases	Short-circuit releases Non-delayed			
I_{cu} kA	I_{cu} kA	I_{cu} kA	I_{cu} kA	$I_n = I_u$ A	I_r A	$I_i = I_n \times \dots$			
									
System and cable protection									
Adjustable overload release I_r									
Normal switching capacity									
	35	-	-	-	80	63-80	6-10	Screw terminals as accessories	
					100	80-100	6-10		
					125	100-125	6-10		
	35	35	25	-	20	15-20	350 A fixed	NZMN2-A20-NA 269217	S
				-	25	20-25	350 A fixed	NZMN2-A25-NA 269218	S
				-	32	25-32	350 A fixed	NZMN2-A32-NA 269219	S
				-	40	32-40	8-10	NZMN2-A40-NA 269220	S
				-	50	40-50	6-10	NZMN2-A50-NA 269221	S
				-	63	50-63	6-10	NZMN2-A63-NA 269222	S
				-	80	63-80	6-10	NZMN2-A80-NA 269223	S
				-	100	80-100	6-10	NZMN2-A100-NA 269224	S
				-	125	100-125	6-10	NZMN2-A125-NA 269225	S
				-	160	125-160	6-10	NZMN2-A160-NA 269226	S
				-	200	160-200	6-10	NZMN2-A200-NA 269227	S
				-	250	200-250	6-10	NZMN2-A250-NA 271106	S
High switching capacity									
	150	150	65	-	20	15-20	350 A fixed	NZMH2-A20-NA 269228	S
					25	20-25	350 A fixed	NZMH2-A25-NA 269229	S
					32	25-32	350 A fixed	NZMH2-A32-NA 269230	S
					40	32-40	8-10	NZMH2-A40-NA 269231	S
					50	40-50	6-10	NZMH2-A50-NA 269232	S
					63	50-63	6-10	NZMH2-A63-NA 269233	S
					80	63-80	6-10	NZMH2-A80-NA 269234	S
					100	80-100	6-10	NZMH2-A100-NA 269235	S
					125	100-125	6-10	NZMH2-A125-NA 269236	S
	100	100	50	-	160	125-160	6-10	NZMH2-A160-NA 269237	S
					200	160-200	6-10	NZMH2-A200-NA 269238	S
					250	200-250	6-10	NZMH2-A250-NA 271107	S

<p>Fixed mounting with box terminals</p> <p>Part no. Article no.</p> <p>Price See price list</p>	<p>Std. pack</p>	<p>Information relevant for export to North America</p> <p></p>	<p>Notes</p>
<p>B = box terminals S = screw terminals</p>			
<p>NZMN1-A80-NA 274241</p>	<p>B</p>	<p>1 off </p> <p>Product Standards UL 489; CSA-C22.2 No. 5-09; IEC 60947-2; CE marking</p> <p>Max. Voltage Rating 480Y/277 V</p> <p>Other Standards as NZMN2... below.</p>	<p>Switches correspond with both UL/CSA and IEC regulations. IEC switching performance values shown on type label.</p>
<p>NZMN1-A100-NA 274242</p>	<p>B</p>		
<p>NZMN1-A125-NA 281573</p>	<p>B</p>		
<p>NZMN2-A20-BT-NA 107785</p>	<p>B</p>	<p>Product Standards UL 489; CSA-C22.2 No. 5-09; IEC 60947-2; CE marking</p> <p>UL File No. E31593</p> <p>UL CCN DIVQ</p> <p>CSA File No. 022086</p> <p>CSA Class No. 1432-01</p> <p>NA Certification UL Listed, CSA Certified</p> <p>Specially designed for NA Yes</p> <p>Suitable for Feeder circuits, Branch Circuits</p> <p>Current Limiting CB Yes</p> <p>Max. Voltage Rating 600Y/347 V, 480 V</p> <p>Degree of Protection IEC: IP20; UL/CSA Type: -</p>	
<p>NZMN2-A25-BT-NA 107786</p>	<p>B</p>		
<p>NZMN2-A32-BT-NA 107787</p>	<p>B</p>		
<p>NZMN2-A40-BT-NA 107788</p>	<p>B</p>		
<p>NZMN2-A50-BT-NA 107789</p>	<p>B</p>		
<p>NZMN2-A63-BT-NA 107790</p>	<p>B</p>		
<p>NZMN2-A80-BT-NA 107791</p>	<p>B</p>		
<p>NZMN2-A100-BT-NA 107792</p>	<p>B</p>		
<p>NZMN2-A125-BT-NA 107793</p>	<p>B</p>		
<p>NZMN2-A160-BT-NA 107794</p>	<p>B</p>		
<p>NZMN2-A200-BT-NA 107795</p>	<p>B</p>		
<p>NZMN2-A250-BT-NA 107796</p>	<p>B</p>		
<p>NZMH2-A20-BT-NA 107797</p>	<p>B</p>		
<p>NZMH2-A25-BT-NA 107798</p>	<p>B</p>		
<p>NZMH2-A32-BT-NA 107799</p>	<p>B</p>		
<p>NZMH2-A40-BT-NA 107800</p>	<p>B</p>		
<p>NZMH2-A50-BT-NA 107801</p>	<p>B</p>		
<p>NZMH2-A63-BT-NA 107802</p>	<p>B</p>		
<p>NZMH2-A80-BT-NA 107803</p>	<p>B</p>		
<p>NZMH2-A100-BT-NA 107804</p>	<p>B</p>		
<p>NZMH2-A125-BT-NA 107805</p>	<p>B</p>		
<p>NZMH2-A160-BT-NA 107806</p>	<p>B</p>		
<p>NZMH2-A200-BT-NA 107807</p>	<p>B</p>		
<p>NZMH2-A250-BT-NA 107808</p>	<p>B</p>		



Switching capacity				Rated current = Rated uninterrupted current	Setting range		Fixed mounting Part no. Article no.	Price See price list	Std. pack
SCCR 480Y/ 277 V 60 Hz	SCCR 480 V 60 Hz	SCCR 600Y/ 347 V 60 Hz	SCCR 600 V 60 Hz		Overload releases	Short-circuit releases Non- delayed			
I_{cu} kA	I_{cu} kA	I_{cu} kA	I_{cu} kA	$I_n = I_u$ A	I_r A	$I_i = I_n \times \dots$			
									

System and cable protection

Fixed overload release I_r
R.m.s. value measurement and "thermal memory"

Normal switching capacity

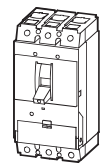

42	42	35	35	250	250	2-11
				300	300	2-11
				350	350	2-11
				400	400	2-11
				450	450	2-8
				500	500	2-8
				550	550	2-8
				600	600	2-8

1)	NZMN3-AEF250-NA 269275	S
	NZMN3-AEF300-NA 269276	S
	NZMN3-AEF350-NA 269277	S
	NZMN3-AEF400-NA 269278	S
	NZMN3-AEF450-NA 269279	S
	NZMN3-AEF500-NA 269280	S
	NZMN3-AEF550-NA 269281	S
	NZMN3-AEF600-NA 269282	S

1 off 

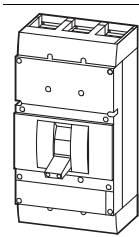

42	42	35	35	600	600	2-12
				700	700	2-12
				800	800	2-12
				900	900	2-12
				1000	1000	2-12
				1200	1200	2-12

2)	NZMN4-AEF600-NA 271108	S
	NZMN4-AEF700-NA 271109	S
	NZMN4-AEF800-NA 271110	S
	NZMN4-AEF900-NA 271111	S
	NZMN4-AEF1000-NA 271112	S
	NZMN4-AEF1200-NA 271113	S

High switching capacity

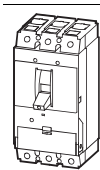

100	100	50	50	250	250	2-11
				300	300	2-11
				350	350	2-11
				400	400	2-11
				450	450	2-8
				500	500	2-8
				550	550	2-8
				600	600	2-8



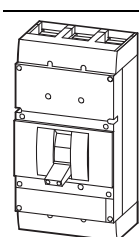

1)	NZMH3-AEF250-NA 269283	S
	NZMH3-AEF300-NA 269284	S
	NZMH3-AEF350-NA 269285	S
	NZMH3-AEF400-NA 269286	S
	NZMH3-AEF450-NA 269287	S
	NZMH3-AEF500-NA 269288	S
	NZMH3-AEF550-NA 269289	S
	NZMH3-AEF600-NA 269290	S

1 off 

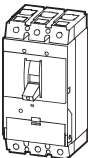

85	85	50	50	600	600	2-12
				700	700	2-12
				800	800	2-12
				900	900	2-12
				1000	1000	2-12
				1200	1200	2-12

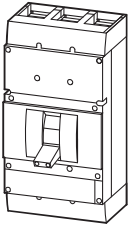
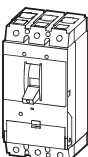
2)	NZMH4-AEF600-NA 271114	S
	NZMH4-AEF700-NA 271115	S
	NZMH4-AEF800-NA 271116	S
	NZMH4-AEF900-NA 271117	S
	NZMH4-AEF1000-NA 271118	S
	NZMH4-AEF1200-NA 271119	S

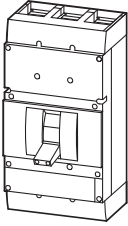
Switching capacity								Rated current = Rated uninterrupted current	Setting range		Fixed mounting Part no. Article no.	Price See price list	Std. pack
SCCR 480Y/ 277 V 60 Hz	SCCR 480 V 60 Hz	SCCR 600Y/ 347 V 60 Hz	SCCR 600 V 60 Hz	Overload releases	Short-circuit releases Non- delayed								
I_{cu} kA	I_{cu} kA	I_{cu} kA	I_{cu} kA	$I_n = I_u$ A	I_r A	$I_i = I_n \times \dots$							
System and cable protection													
Adjustable overload release I_r R.m.s. value measurement and "thermal memory"													
Normal switching capacity													
	42	42	35	35	250	125-250	2-11	1)	NZMN3-AE250-NA 269299	S	1 off 		
					400	200-400	2-11		NZMN3-AE400-NA 269300	S			
					600	300-600	2-8		NZMN3-AE600-NA 269301	S			
	42	42	35	35	800	400-800	2-12	2)	NZMN4-AE800-NA 271120	S			
					1000	500-1000	2-12		NZMN4-AE1000-NA 271121	S			
					1200	600-1200	2-12		NZMN4-AE1200-NA 271122	S			
High switching capacity													
	100	100	50	50	250	125-250	2-11	1)	NZMH3-AE250-NA 269302	S	1 off 		
					400	200-400	2-11		NZMH3-AE400-NA 269303	S			
					600	300-600	2-8		NZMH3-AE600-NA 269304	S			
	85	85	50	50	800	400-800	2-12	2)	NZMH4-AE800-NA 271123	S			
					1000	500-1000	2-12		NZMH4-AE1000-NA 271124	S			
					1200	600-1200	2-12		NZMH4-AE1200-NA 271125	S			

Notes Switches correspond with both UL/CSA and IEC regulations. IEC switching performance values shown on type label.

B = box terminals
S = screw terminals

Information relevant for export to North America





Product Standards	UL 489; CSA-C22.2 No. 5-09; IEC 60947-2; CE marking
UL File No.	E31593
UL CCN	DIVQ
CSA File No.	022086
CSA Class No.	1432-01
NA Certification	UL Listed, CSA certified
Specially designed for NA	Yes
Suitable for	Feeder circuits, branch circuits
Current Limiting CB	¹⁾ Yes ²⁾ No
Max. Voltage Rating	600 V
Degree of Protection	IEC: IP20; UL/CSA Type: -





										Fixed mounting		
										Part no. Article no.	Price See price list	
Switching capacity				Rated current = Rated uninterrupted current	Setting range							
SCCR 480Y/ 277 V 60 Hz	SCCR 480 V 60 Hz	SCCR 600Y/ 347 V 60 Hz	SCCR 600 V 60 Hz		$I_n = I_u$	Overload releases		Short-circuit releases				
I_{cu}	I_{cu}	I_{cu}	I_{cu}	I_r		Fixed	Non- delayed	Delayed				
kA	kA	kA	kA		A			A	$I_i = I_n \times \dots$	$I_{sd} = I_r \times \dots$		
Systems protection, cable protection, selectivity, generator protection												
Fixed overload release I_r R.m.s. value measurement and "thermal memory"												
Normal switching capacity												
	35	35	25	-	150	150	1800 A fixed	2-10	NZMN2-VEF150-NA 271126	S		
					175	175	2100 A fixed	2-10	NZMN2-VEF175-NA 271127	S		
					200	200	2400 A fixed	2-10	NZMN2-VEF200-NA 271128	S		
					225	225	2700 A fixed	2-10	NZMN2-VEF225-NA 271129	S		
					250	250	3000 A fixed	2-10	NZMN2-VEF250-NA 271130	S		
	42	42	35	35	250	250	2-11	2-10	NZMN3-VEF250-NA 269308	S		
					300	300	2-11	2-10	NZMN3-VEF300-NA 269309	S		
					350	350	2-11	2-10	NZMN3-VEF350-NA 269310	S		
					400	400	2-11	2-10	NZMN3-VEF400-NA 269311	S		
					450	450	2-8	1.5-7	NZMN3-VEF450-NA 269312	S		
					500	500	2-8	1.5-7	NZMN3-VEF500-NA 269313	S		
					550	550	2-8	1.5-7	NZMN3-VEF550-NA 269314	S		
					600	600	2-8	1.5-7	NZMN3-VEF600-NA 269315	S		
	42	42	35	35	600	600	2-12	2-10	NZMN4-VEF600-NA 271136	S		
					700	700	2-12	2-10	NZMN4-VEF700-NA 271137	S		
					800	800	2-12	2-10	NZMN4-VEF800-NA 271138	S		
					900	900	2-12	2-10	NZMN4-VEF900-NA 271139	S		
					1000	1000	2-12	2-10	NZMN4-VEF1000-NA 271140	S		
					1200	1200	2-12	2-10	NZMN4-VEF1200-NA 271141	S		

Fixed mounting with box terminals		Std. pack	Information relevant for export to North America	Notes
Part no. Article no.	Price See price list			
NZMN2-VEF150-BT-NA 107593		B	1 off 	Switches correspond with both UL/CSA and IEC regulations. IEC switching performance values shown on type label. Adjustable delay setting t_r • 2 – 20 s at 6 x I_r Adjustable delay t_{sd} • Steps 0, 20, 60, 100, 200, 300, 500, 750, 1000 ms i ² t constant function • NZM2 fixed OFF • NZM3, NZM4 switchable (ex-works OFF)
NZMN2-VEF175-BT-NA 107594		B		
NZMN2-VEF200-BT-NA 107595		B		
NZMN2-VEF225-BT-NA 107596		B		
NZMN2-VEF250-BT-NA 107597		B		
Terminals as accessory			1 off 	
Terminals as accessory			1 off 	

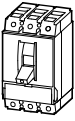
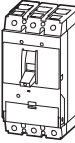
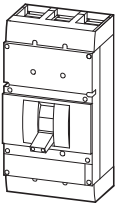



										Fixed mounting	
										Part no. Article no.	Price See price list
Switching capacity				Rated current = Rated uninterrupted current	Setting range						
SCCR 480Y/ 277 V 60 Hz	SCCR 480 V 60 Hz	SCCR 600Y/ 347 V 60 Hz	SCCR 600 V 60 Hz		$I_n = I_u$	Overload releases Fixed	Short-circuit releases		$I_i = I_n \times \dots$	$I_{sd} = I_r \times \dots$	
I_{cu}	I_{cu}	I_{cu}	I_{cu}	I_r			Non- delayed	Delayed			
kA	kA	kA	kA	A	A						
											
Systems protection, cable protection, selectivity, generator protection											
Fixed overload release I_r R.m.s. value measurement and "thermal memory"											
High switching capacity											
	100	100	50	-	150	150	1800 A fixed	2-10	NZMH2-VEF150-NA 271131	S	
				-	175	175	2100 A fixed	2-10	NZMH2-VEF175-NA 271132	S	
				-	200	200	2400 A fixed	2-10	NZMH2-VEF200-NA 271133	S	
				-	225	225	2700 A fixed	2-10	NZMH2-VEF225-NA 271134	S	
				-	250	250	3000 A fixed	2-10	NZMH2-VEF250-NA 271135	S	
	100	100	50	50	250	250	2-11	2-10	NZMH3-VEF250-NA 269316	S	
					300	300	2-11	2-10	NZMH3-VEF300-NA 269317	S	
					350	350	2-11	2-10	NZMH3-VEF350-NA 269318	S	
					400	400	2-11	2-10	NZMH3-VEF400-NA 269319	S	
					450	450	2-8	1.5-7	NZMH3-VEF450-NA 269320	S	
					500	500	2-8	1.5-7	NZMH3-VEF500-NA 269321	S	
					550	550	2-8	1.5-7	NZMH3-VEF550-NA 269322	S	
	85	85	50	50	600	600	2-12	2-10	NZMH4-VEF600-NA 271142	S	
					700	700	2-12	2-10	NZMH4-VEF700-NA 271143	S	
					800	800	2-12	2-10	NZMH4-VEF800-NA 271144	S	
					900	900	2-12	2-10	NZMH4-VEF900-NA 271145	S	
					1000	1000	2-12	2-10	NZMH4-VEF1000-NA 271146	S	
					1200	1200	2-12	2-10	NZMH4-VEF1200-NA 271147	S	



Fixed mounting with box terminals					
Part no. Article no.	Price See price list	Std. pack	Information relevant for export to North America		Notes
					
NZMH2-VEF150-BT-NA 107598		B	1 off 	Product Standards UL File No. UL CCN CSA File No. CSA Class No. NA Certification Specially designed for NA Suitable for Current Limiting CB Max. Voltage Rating Degree of Protection	IEC switching performance values shown on type label. Adjustable delay setting t_r • 2 – 20 s at 6 x I_r Adjustable delay t_{sd} • Steps 0, 20, 60, 100, 200, 300, 500, 750, 1000 ms i ² t constant function • NZM2 fixed OFF • NZM3, NZM4 switchable (ex-works OFF)
NZMH2-VEF175-BT-NA 107599		B		UL 489; CSA-C22.2 No. 5-09; IEC 60947-2; CE marking E31593 DIVQ 022086 1432-01 UL Listed, CSA certified Yes Feeder circuits, branch circuits Yes 600Y/347 V, 480 V IEC: IP20; UL/CSA Type: -	
NZMH2-VEF200-BT-NA 107840		B			
NZMH2-VEF225-BT-NA 107841		B			
NZMH2-VEF250-BT-NA 107842		B			
Terminals as accessory			1 off 	Product Standards UL File No. UL CCN CSA File No. CSA Class No. NA Certification Specially designed for NA Suitable for Current Limiting CB Max. Voltage Rating Degree of Protection	
Terminals as accessory				UL 489; CSA-C22.2 No. 5-09; IEC 60947-2; CE marking E31593 DIVQ 022086 1432-01 UL Listed, CSA certified Yes Feeder circuits, branch circuits Yes 600 V IEC: IP20; UL/CSA Type: -	





									Fixed mounting	
Switching capacity				Rated current = Rated uninterrupted current	Setting range			Part no. Article no.	Price See price list	
SCCR 480Y/ 277 V 60 Hz	SCCR 480 V 60 Hz	SCCR 600Y/ 347 V 60 Hz	SCCR 600 V 60 Hz		Overload releases	Short-circuit releases				
I_{cu}	I_{cu}	I_{cu}	I_{cu}			Non- delayed	Delayed			
kA	kA	kA	kA	$I_n = I_u$	I_r	$I_i = I_n \times \dots$	$I_{sd} = I_r \times \dots$			
Systems protection, cable protection, selectivity, generator protection										
Adjustable overload release I_r R.m.s. value measurement and "thermal memory"										
Normal switching capacity										
	35	35	25	-	100	50-100	1200 A fixed	2-10	NZMN2-VE100-NA 271148	S
					160	80-160	1920 A fixed	2-10	NZMN2-VE160-NA 271149	S
					250	125-250	3000 A fixed	2-10	NZMN2-VE250-NA 271150	S
	42	42	35	35	250	125-250	2-11	2-10	NZMN3-VE250-NA 269332	S
					400	200-400	2-11	2-10	NZMN3-VE400-NA 269333	S
					600	300-600	2-8	1.5-7	NZMN3-VE600-NA 269334	S
	42	42	35	35	800	400-800	2-12	2-10	NZMN4-VE800-NA 271154	S
					1000	500-1000	2-12	2-10	NZMN4-VE1000-NA 271155	S
					1200	630-1200	2-12	2-10	NZMN4-VE1200-NA 271156	S
High switching capacity										
	100	100	50	-	100	50-100	1200 A fixed	2-10	NZMH2-VE100-NA 271151	S
					160	80-160	1920 A fixed	2-10	NZMH2-VE160-NA 271152	S
					250	125-250	3000 A fixed	2-10	NZMH2-VE250-NA 271153	S
	100	100	50	50	250	125-250	2-11	2-10	NZMH3-VE250-NA 269335	S
					400	200-400	2-11	2-10	NZMH3-VE400-NA 269336	S
					600	300-600	2-8	1.5-7	NZMH3-VE600-NA 269337	S
	85	85	50	50	800	400-800	2-12	2-10	NZMH4-VE800-NA 271157	S
					1000	500-1000	2-12	2-10	NZMH4-VE1000-NA 271158	S
					1200	630-1200	2-12	2-10	NZMH4-VE1200-NA 271159	S

Fixed mounting with box terminals Part no. Article no.	Price See price list	Std. pack	Information relevant for export to North America 	Notes
NZMN2-VE100-BT-NA 107843	B	1 off 	Product Standards UL 489; CSA-C22.2 No. 5-09; IEC 60947-2; CE marking UL File No. E31593 UL CCN DIVQ CSA File No. 022086 CSA Class No. 1432-01 NA Certification UL Listed, CSA certified Specially designed for NA Yes Suitable for Feeder circuits, branch circuits Current Limiting CB Yes Max. Voltage Rating 600Y/347 V, 480 V Degree of Protection IEC: IP20; UL/CSA Type: -	Switches correspond with both UL/CSA and IEC regulations. IEC switching performance values shown on type label. Adjustable delay setting t_r • 2 – 20 s at 6 x I_r Adjustable delay t_{sd} • Steps: 0, 20, 60, 100, 200, 300, 500, 750, 1000 ms i^2t constant function • NZM2 fixed OFF • NZM3, NZM4 switchable (ex-works OFF)
NZMN2-VE160-BT-NA 107844	B		Product Standards UL 489; CSA-C22.2 No. 5-09; IEC 60947-2; CE marking UL File No. E31593 UL CCN DIVQ CSA File No. 022086 CSA Class No. 1432-01 NA Certification UL Listed, CSA certified Specially designed for NA Yes Suitable for Feeder circuits, branch circuits Current Limiting CB Yes Max. Voltage Rating 600Y/347 V, 480 V Degree of Protection IEC: IP20; UL/CSA Type: -	
NZMN2-VE250-BT-NA 107845	B		Product Standards UL 489; CSA-C22.2 No. 5-09; IEC 60947-2; CE marking UL File No. E31593 UL CCN DIVQ CSA File No. 022086 CSA Class No. 1432-01 NA Certification UL Listed, CSA certified Specially designed for NA Yes Suitable for Feeder circuits, branch circuits Current Limiting CB Yes Max. Voltage Rating 600Y/347 V, 480 V Degree of Protection IEC: IP20; UL/CSA Type: -	
Terminals as accessory			Product Standards UL 489; CSA-C22.2 No. 5-09; IEC 60947-2; CE marking UL File No. E31593 UL CCN DIVQ CSA File No. 022086 CSA Class No. 1432-01 NA Certification UL Listed, CSA certified Specially designed for NA Yes Suitable for Feeder circuits, branch circuits Current Limiting CB Yes Max. Voltage Rating 600 V Degree of Protection IEC: IP20; UL/CSA Type: -	
NZMH2-VE100-BT-NA 107846	B	1 off 	Product Standards UL 489; CSA-C22.2 No. 5-09; IEC 60947-2; CE marking UL File No. E31593 UL CCN DIVQ CSA File No. 022086 CSA Class No. 1432-01 NA Certification UL Listed, CSA certified Specially designed for NA Yes Suitable for Feeder circuits, branch circuits Current Limiting CB Yes Max. Voltage Rating 600Y/347 V, 480 V Degree of Protection IEC: IP20; UL/CSA Type: -	
NZMH2-VE160-BT-NA 107847	B		Product Standards UL 489; CSA-C22.2 No. 5-09; IEC 60947-2; CE marking UL File No. E31593 UL CCN DIVQ CSA File No. 022086 CSA Class No. 1432-01 NA Certification UL Listed, CSA certified Specially designed for NA Yes Suitable for Feeder circuits, branch circuits Current Limiting CB Yes Max. Voltage Rating 600Y/347 V, 480 V Degree of Protection IEC: IP20; UL/CSA Type: -	
NZMH2-VE250-BT-NA 107848	B		Product Standards UL 489; CSA-C22.2 No. 5-09; IEC 60947-2; CE marking UL File No. E31593 UL CCN DIVQ CSA File No. 022086 CSA Class No. 1432-01 NA Certification UL Listed, CSA certified Specially designed for NA Yes Suitable for Feeder circuits, branch circuits Current Limiting CB Yes Max. Voltage Rating 600 V Degree of Protection IEC: IP20; UL/CSA Type: -	
Terminals as accessory			Product Standards UL 489; CSA-C22.2 No. 5-09; IEC 60947-2; CE marking UL File No. E31593 UL CCN DIVQ CSA File No. 022086 CSA Class No. 1432-01 NA Certification UL Listed, CSA certified Specially designed for NA Yes Suitable for Feeder circuits, branch circuits Current Limiting CB Yes Max. Voltage Rating 600 V Degree of Protection IEC: IP20; UL/CSA Type: -	



	Rated current = Rated uninterrupted current	Setting range	Fixed mounting with screw terminals	Price
	$I_n = I_u$ A	Short-circuit releases Non-delayed $I_i = I_n \times \dots$ 	Part no. Article no.	See price list
Short-circuit protection				
Motor protection in conjunction with contactor and overload relay				
<ul style="list-style-type: none"> • With short-circuit release • Without overload release I_r 				
Basic switching capacity				
	1.2	7-12	Screw terminals as accessories	
	2	6-11		
	3	6-11		
	5	6-11		
	8	6-11		
	12	7-12		
	18	7-12		
	26	8-13		
	33	8-14		
	40	8-14		
	50	8-14		
	63	8-14		
	80	8-14		
	100	8-13		
	1.6	8-14	NZMB2-S1.6-CNA 269472	S
	2.4	8-14	NZMB2-S2.4-CNA 269473	S
	5	6-11	NZMB2-S5-CNA 103034	S
	8	6-11	NZMB2-S8-CNA 103035	S
	12	7-12	NZMB2-S12-CNA 103036	S
	18	7-12	NZMB2-S18-CNA 103037	S
	26	8-13	NZMB2-S26-CNA 103038	S
	33	8-14	NZMB2-S33-CNA 103039	S
	40	8-14	NZMB2-S40-CNA 269243	S
	50	8-14	NZMB2-S50-CNA 269244	S
	63	8-14	NZMB2-S63-CNA 269245	S
	80	8-14	NZMB2-S80-CNA 269246	S
	100	8-14	NZMB2-S100-CNA 269247	S
	125	8-14	NZMB2-S125-CNA 269248	S
	160	8-14	NZMB2-S160-CNA 269249	S
	200	8-13	NZMB2-S200-CNA 269250	S
250	8-10	NZMB2-S250-CNA 102478	S	

Fixed mounting with box terminals	Price See price list	Std. pack	Information relevant for export to North America	Notes
				
				B = box terminals S = screw terminals For further terminal types see accessories
NZMB1-S1.2-CNA 102906		B	1 off  Product Standards UL 489; CSA-C22.2 No. 5-09; IEC 60947-2; CE marking UL File No. E31593 UL CCN DKPU2 CSA File No. 022086 CSA Class No. 1432-01 NA Certification UL Recognized, CSA certified Conditions of Acceptability Only used in motor circuits in conjunction with suitable contactor and overload relay. SCCR value applies for complete combination starter only, consisting of instantaneous trip circuit breaker, contactor and overload relay. Specially designed for NA Yes Suitable for Branch circuits, feeder circuits Max. Voltage Rating 480Y/277 V Degree of Protection IEC: IP20; UL/CSA Type: -	Switches correspond with both UL/CSA and IEC regulations. IEC switching performance values shown on type label.
NZMB1-S2-CNA 102907		B		
NZMB1-S3-CNA 102908		B		
NZMB1-S5-CNA 102909		B		
NZMB1-S8-CNA 103020		B		
NZMB1-S12-CNA 103021		B		
NZMB1-S18-CNA 103022		B		
NZMB1-S26-CNA 103023		B		
NZMB1-S33-CNA 103024		B		
NZMB1-S40-CNA 281263		B		
NZMB1-S50-CNA 281264		B		
NZMB1-S63-CNA 281265		B		
NZMB1-S80-CNA 281266		B		
NZMB1-S100-CNA 281267		B		
NZMB2-S1.6-BT-CNA 107651		B	1 off  Product Standards UL 489; CSA-C22.2 No. 5-09; IEC 60947-2; CE marking UL File No. E31593 UL CCN DKPU2 CSA File No. 022086 CSA Class No. 1432-01 NA Certification UL Recognized, CSA certified Conditions of Acceptability Only used in motor circuits in conjunction with suitable contactor and overload relay. SCCR value applies for complete combination starter only, consisting of instantaneous trip circuit breaker, contactor and overload relay. Specially designed for NA Yes Suitable for Branch circuits, feeder circuits Max. Voltage Rating 600Y/347 V, 480 V Degree of Protection IEC: IP20; UL/CSA Type: -	Switches correspond with both UL/CSA and IEC regulations. IEC switching performance values shown on type label.
NZMB2-S2.4-BT-CNA 107652		B		
NZMB2-S5-BT-CNA 107653		B		
NZMB2-S8-BT-CNA 107654		B		
NZMB2-S12-BT-CNA 107655		B		
NZMB2-S18-BT-CNA 107656		B		
NZMB2-S26-BT-CNA 107657		B		
NZMB2-S33-BT-CNA 107658		B		
NZMB2-S40-BT-CNA 107659		B		
NZMB2-S50-BT-CNA 107660		B		
NZMB2-S63-BT-CNA 107661		B		
NZMB2-S80-BT-CNA 107662		B		
NZMB2-S100-BT-CNA 107663		B		
NZMB2-S125-BT-CNA 107664		B		
NZMB2-S160-BT-CNA 107665		B		
NZMB2-S200-BT-CNA 107666		B		
NZMB2-S250-BT-CNA 107667		B		



Rated current =
Rated uninterrupted current

Setting range

$I_n = I_u$
A

Short-circuit releases

Non-delayed

$I_i = I_n \times \dots$



Fixed mounting
with screw terminals

Part no.
Article no.

Price
See price
list

Std. pack

Short-circuit protection

Motor protection in conjunction with contactor and overload relay

- With short-circuit release
- Without overload release I_r

Normal switching capacity



1.2	7-12
2	6-11
3	6-11
5	6-11
8	6-11
12	7-12
18	7-12
26	8-13
33	8-14
40	8-14
50	8-14
63	8-14
80	8-14
100	8-13

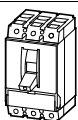

1.6	8-14
2.4	8-14
5	6-11
8	6-11
12	7-12
18	7-12
26	8-13
33	8-14
40	8-14
50	8-14
63	8-14
80	8-14
100	8-14
125	8-14
160	8-14
200	8-13
250	8-10



1)

NZMN1-S1.2-CNA 103025	B
NZMN1-S2-CNA 103026	B
NZMN1-S3-CNA 103027	B
NZMN1-S5-CNA 103028	B
NZMN1-S8-CNA 103029	B
NZMN1-S12-CNA 103030	B
NZMN1-S18-CNA 103031	B
NZMN1-S26-CNA 103032	B
NZMN1-S33-CNA 103033	B
NZMN1-S40-CNA 281276	B
NZMN1-S50-CNA 281277	B
NZMN1-S63-CNA 281278	B
NZMN1-S80-CNA 281279	B
NZMN1-S100-CNA 281280	B

2)

NZMN2-S1.6-CNA 269478	S
NZMN2-S2.4-CNA 269479	S
NZMN2-S5-CNA 103040	S
NZMN2-S8-CNA 103041	S
NZMN2-S12-CNA 103042	S
NZMN2-S18-CNA 103043	S
NZMN2-S26-CNA 103044	S
NZMN2-S33-CNA 103045	S
NZMN2-S40-CNA 269255	S
NZMN2-S50-CNA 269256	S
NZMN2-S63-CNA 269257	S
NZMN2-S80-CNA 269258	S
NZMN2-S100-CNA 269259	S
NZMN2-S125-CNA 269260	S
NZMN2-S160-CNA 269261	S
NZMN2-S200-CNA 269262	S
NZMN2-S250-CNA 102479	S

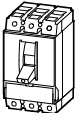
1 off

Rated current = Rated uninterrupted current	Setting range	Short-circuit releases	Fixed mounting with screw terminals	Price	Std. pack
$I_n = I_u$ A	Non-delayed $I_i = I_n \times \dots$ 		Part no. Article no.	See price list	
Short-circuit protection					
Motor protection in conjunction with contactor and overload relay					
<ul style="list-style-type: none"> • With short-circuit release • Without overload release I_r 					
High switching capacity					
	1.6	8-14	2) NZMH2-S1.6-CNA 269482	S	1 off 
	2.4	8-14	NZMH2-S2.4-CNA 269483	S	
	5	6-11	NZMH2-S5-CNA 103046	S	
	8	6-11	NZMH2-S8-CNA 103047	S	
	12	7-12	NZMH2-S12-CNA 103048	S	
	18	5-9	NZMH2-S18-CNA 103049	S	
	26	8-13	NZMH2-S26-CNA 103050	S	
	33	8-14	NZMH2-S33-CNA 103051	S	
	40	8-14	NZMH2-S40-CNA 269267	S	
	50	8-14	NZMH2-S50-CNA 269268	S	
	63	8-14	NZMH2-S63-CNA 269269	S	
	80	8-14	NZMH2-S80-CNA 269270	S	
	100	8-14	NZMH2-S100-CNA 269271	S	
	125	8-14	NZMH2-S125-CNA 269272	S	
	160	8-14	NZMH2-S160-CNA 269273	S	
	200	8-13	NZMH2-S200-CNA 269274	S	
	250	8-10	NZMH2-S250-CNA 102490	S	

Notes

B = box terminals
S = screw terminals

For further terminal types see accessories

Switches correspond with both UL/CSA and IEC regulations.
IEC switching performance values shown on type label.

Information relevant for export to North America



Product Standards

UL File No.
UL CCN
CSA File No.
CSA Class No.
NA Certification
Conditions of Acceptability

Specially designed for NA
Suitable for
Max. Voltage Rating

Degree of Protection



UL 489; CSA-C22.2 No. 5-09; IEC 60947-2; CE marking

E31593
DKPU2
022086
1432-01
UL Recognized, CSA certified
Only used in motor circuits in conjunction with suitable contactor and overload relay. SCCR value applies for complete combination starter only, consisting of instantaneous trip circuit breaker, contactor and overload relay.

Yes
Branch circuits, feeder circuits
1) 480Y/277 V
2) 600Y/347 V, 480 V

IEC: IP20; UL/CSA Type: -



Switching capacity	Rated current = Rated uninterrupted current	Setting range	Motor power	Fixed mounting with screw terminals	Part no. Article no.	Price See Price list
SCCR 480V/ 277 V 60 Hz	SCCR 480 V 60 Hz	Overload releases	460 V 480 V HP			
I_{cu} kA	$I_n = I_u$ A	Short-circuit releases	Non-delayed			
		I_r A	$I_i = I_n \times \dots$			
						

Motor protection

100% rated

Adjustable overload releases

For use in motor circuits with contactor.

Additional motor protective characteristics (calibration) to UL508, CSA-C22.2 No. 14-05.

Normal switching capacity

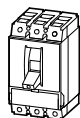

35	35	90	45-90	2-14	60
		140	70-140	2-14	100
		200	100-200	2-14	150



NZMN2-ME90-NA 118964	S
NZMN2-ME140-NA 118965	S
NZMN2-ME200-NA 118966	S

High switching capacity



100	100	90	45-90	2-14	60
		140	70-140	2-14	100
		200	100-200	2-14	150

NZMH2-ME90-NA 118967	S
NZMH2-ME140-NA 118968	S
NZMH2-ME200-NA 118969	S

Rated current = Rated uninterrupted current	Setting range Short- circuit releases	Fixed mounting with screw terminals	Part no. Article no.	Price See price list	Std. pack	Information relevant for export to North America	Notes
$I_n = I_u$ A	Non- delayed $I_i = I_n \times \dots$						
						 	

Short-circuit protection

Motor protection in conjunction with contactor and overload relay

- With short-circuit release
- Without overload release I_r

B = box terminals



S = screw terminals

For further terminal types see accessories

Normal switching capacity



90	2-14	NZMN2-SE90-CNA 271160	S
140	2-14	NZMN2-SE140-CNA 271161	S
220	2-14	NZMN2-SE220-CNA 271162	S

1 off	 	Product Standards	UL 489; CSA-C22.2 No. 5-09; IEC 60947-2; CE marking	Switches correspond with both UL/CSA and IEC regulations. IEC switching performance values shown on type label.
		UL File No.	E31593	
		UL CCN	DKPU2	
		CSA File No.	022086	
		CSA Class No.	1432-01	
		NA Certification	UL Recognized, CSA certified	
		Conditions of Acceptability	Only used in motor circuits in conjunction with suitable contactor and overload relay. SCCR value applies for complete combination starter only, consisting of instantaneous trip circuit breaker, contactor and overload relay.	
		Specially designed for NA Suitable for	Yes Branch circuits, feeder circuits	
		Max. Voltage Rating	480 V	
		Degree of Protection	IEC: IP20; UL/CSA Type: -	

HPL17077EN



Fixed mounting with box terminals		Std. pack	Information relevant for export to North America	Notes
Part no. Article no.	Price See Price list			
				B = box terminals S = screw terminals For further terminal types see accessories
NZMN2-ME90-BT-NA 142421	S	1 off 	Product Standards UL 489; CSA-C22.2 No. 5-09; IEC 60947-2; CE marking UL CCN NA Certification Specially designed for NA Suitable for Max. Voltage Rating Degree of Protection	Switches correspond with both UL/CSA and IEC regulations. IEC switching performance values shown on type label. Adjustable delay setting t_r • 2 – 20 s at 6 x I_n
NZMN2-ME140-BT-NA 142422	S			
NZMN2-ME200-BT-NA 142423	S			
NZMH2-ME90-BT-NA 142424	S	1 off 	Max. Voltage Rating Degree of Protection	
NZMH2-ME140-BT-NA 142425	S			
NZMH2-ME200-BT-NA 142426	S			

Rated current = Rated uninter- rupted current	Setting range Short-circuit releases Non-delayed $I_i = I_n \times \dots$	Part no. Article no.	Price See price list	Std. pack	Information relevant for export to North America	Notes
$I_n = I_u$						
A						

Short-circuit protection	B = box terminals S = screw terminals
Motor protection in conjunction with contactor and overload relay <ul style="list-style-type: none"> • With short-circuit release • Without overload release I_r 	For further terminal types see accessories

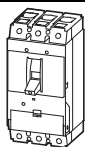
Normal switching capacity		Std. pack	Information relevant for export to North America	Notes
Rated current	Setting range			
220	2-14	S	Product Standards UL 489; CSA-C22.2 No. 5-09; IEC 60947-2; CE marking UL File No. UL CCN CSA File No. CSA Class No. NA Certification Conditions of Acceptability Specially designed for NA Suitable for Max. Voltage Rating Degree of Protection	Switches correspond with both UL/CSA and IEC regulations. IEC switching performance values shown on type label. Only used in motor circuits in conjunction with suitable contactor and overload relay. SCCR value applies for complete combination starter only, consisting of instantaneous trip circuit breaker, contactor and overload relay. Yes Branch circuits, feeder circuits 600 V IEC: IP20; UL/CSA Type: -
350	2-14	S		
450	2-12	S		



Switching capacity				Rated current = Rated uninterrupted current	Setting range		
SCCR 480Y/ 277 V 60 Hz	SCCR 480 V 60 Hz	SCCR 600Y/ 347 V 60 Hz	SCCR 600 V 60 Hz		Overload releases	Neutral conductor $I_r \times \% \text{ of phase conductor}$	Short-circuit releases Non-delayed $I_i = I_n \times \dots$
I_{cu} kA	I_{cu} kA	I_{cu} kA	I_{cu} kA	$I_n = I_u$ A	I_r A	%	
							

System and cable protection

Fixed overload releases I_r

Basic switching capacity

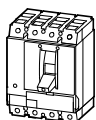

25	25						
		-	-	125	125	100	Approx. 6 - 10
		-	-	150	150	100	Approx. 6 - 10
		-	-	175	175	100	Approx. 6 - 10
		-	-	200	200	100	Approx. 6 - 10
		-	-	225	225	100	Approx. 6 - 10
		-	-	250	250	100	Approx. 6 - 10

Normal switching capacity

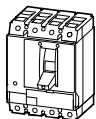





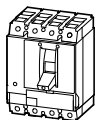



35	35						
		-	-	125	125	100	Approx. 6 - 10
		-	-	150	150	100	Approx. 6 - 10
		-	-	175	175	100	Approx. 6 - 10
		-	-	200	200	100	Approx. 6 - 10
		-	-	225	225	100	Approx. 6 - 10
		-	-	250	250	100	Approx. 6 - 10

High switching capacity





150	150						
		-	-	125	125	100	Approx. 6 - 10
100	100	-	-	150	150	100	Approx. 6 - 10
		-	-	175	175	100	Approx. 6 - 10
		-	-	200	200	100	Approx. 6 - 10
		-	-	225	225	100	Approx. 6 - 10
		-	-	250	250	100	Approx. 6 - 10





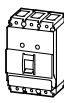

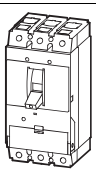
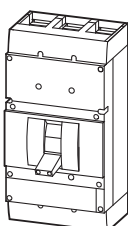
Fixed mounting with box terminals	Part no. Article no.	Price See price list	Std. pack	Information relevant for export to North America	Notes
				 	
					B = box terminals S = screw terminals For further terminal types see accessories
NZMB2-4-AF125-BT-NA 113011			B	1 off  	Product Standards UL 489; CSA-C22.2 No. 5-09; IEC 60947-2; CE marking UL File No. E31593 UL CCN DIVQ CSA File No. - CSA Class No. - NA Certification UL Listed Specially designed for NA Yes Suitable for Feeder circuits, branch circuits Current Limiting CB Yes Max. Voltage Rating 480 V Degree of Protection IEC: IP20; UL/CSA Type: -
NZMB2-4-AF150-BT-NA 113012			B		
NZMB2-4-AF175-BT-NA 113013			B		
NZMB2-4-AF200-BT-NA 113014			B		
NZMB2-4-AF225-BT-NA 113015			B		
NZMB2-4-AF250-BT-NA 113016			B		
NZMN2-4-AF125-BT-NA 113005			B	1 off  	
NZMN2-4-AF150-BT-NA 113006			B		
NZMN2-4-AF175-BT-NA 113007			B		
NZMN2-4-AF200-BT-NA 113008			B		
NZMN2-4-AF225-BT-NA 113009			B		
NZMN2-4-AF250-BT-NA 113010			B		
NZMH2-4-AF125-BT-NA 113017			B	1 off  	
NZMH2-4-AF150-BT-NA 113018			B		
NZMH2-4-AF175-BT-NA 113019			B		
NZMH2-4-AF200-BT-NA 113020			B		
NZMH2-4-AF225-BT-NA 113021			B		
NZMH2-4-AF250-BT-NA 113022			B		



	Rated current = Rated uninterrupted current	Switching capacity				Response value of short-circuit releases	Fixed mounting with screw terminals		
		SCCR 480Y/ 277 V 60 Hz	SCCR 480 V 60 Hz	SCCR 600Y/ 347 V 60 Hz	SCCR 600 V 60 Hz		Part no. Article no.	Price See price list	
	$I_n = I_u$ A	I_{cu} kA	I_{cu} kA	I_{cu} kA	I_{cu} kA	I_t A			
Molded case switches for North America									
With permanently set short-circuit release (self-protection)									
3 switch positions I, +, 0 Can be remotely operated with shunt release XU/XA, remote operator XR, Can be equipped with trip-indicating auxiliary contact M22-K..									
	63	35	—	—	—	1250	Screw terminals as accessories		
	100		—	—	1250				
	125		—	—	1250				
	160	100	100	50	—	2500	NS2-160-NA 102684	S	
	200					2500		NS2-200-NA 102685	S
	250					2500		NS2-250-NA 102686	S
	400	100	100	50	50	6600	NS3-400-NA 102687	S	
	600					6600		NS3-600-NA 102688	S
	800	65	65	42	42	25000	NS4-800-NA 102689	S	
	1000					25000		NS4-1000-NA 102690	S
	1200					25000		NS4-1200-NA 102691	S





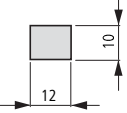
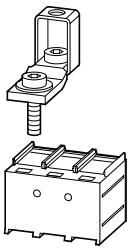
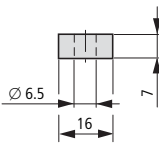
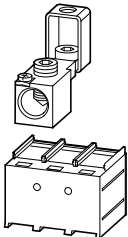
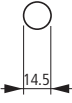
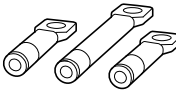

Fixed mounting with box terminals		Std. pack	Information relevant for export to North America	Notes
Part no. Article no.	Price See price list			
				B = box terminals S = screw terminals
				For further terminal types see accessories
NS1-63-NA 102681		B	1 off 	IEC/EN 60947-2: circuit-breaker without overcurrent protection (CBI-X) with main switch characteristics and isolating characteristics to IEC/EN 60204
NS1-100-NA 102682		B		
NS1-125-NA 102683		B		
NS2-160-BT-NA 107578		B	1 off 	IEC/EN 60947-2: circuit-breaker without overcurrent protection (CBI-X) with main switch characteristics and isolating characteristics to IEC/EN 60204
NS2-200-BT-NA 107579		B		
NS2-250-BT-NA 107610		B		
Terminals as accessory			1 off 	





	Max. cable connection area	Number of poles	For use with	Terminal capacity		Terminal capacity		
				Cable Cable lugs	Terminal capacity	AWG/kcmil	Copper strip No. of discs × width × disc thickness	Copper bar width × thickness
				mm ²		mm		mm
Box terminal								
Standard equipment								
 		3 pole	NZM1, PN1, N(S)1	Copper cable	1 x 10 - 70 2 x 6 - 25 1)	1 x 12 - 2/0	≥ 2 x 9 x 0.8	—
		4 pole	NZM1-4, PN1-4, N1-4					
Screw terminals								
 		3 pole	NZM1, PN1, N(S)1	Copper cable lugs	1 x 10 - 70 2 x 6 - 25 1 x 10 - 35	1 x 12 - 2/0	—	≥ 12 x 5
		4 pole	NZM1-4, PN1-4, N1-4	Aluminium cable lugs	2 x 10 - 35 1)			
Tunnel terminal								
 		3 pole	NZM1, PN1, N(S)1	Copper cable ☉ ☿ Aluminium cable ☉ ☿	1 x 16 - 95 1)	1 x 6 - 3/0 -	—	—
		4 pole	NZM1-4, PN1-4, N1-4					
Rear terminal bolts								
Not UL/CSA approved								
		3 pole	NZM1, PN1, N1	Copper cable lugs	1 x 10-70 2 x 6-25 1 x 10-35	—	—	min. 12 x 5 max. 16 x 5
		4 pole	NZM1-4, PN1-4, N1-4	Aluminium cable lugs	2 x 10-35 1)			





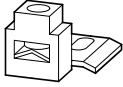
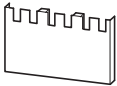
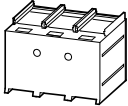

Notes1) Up to 95 mm² can be connected depending on make of cable.

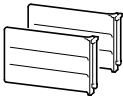
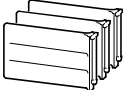
HPL17083EN

Part no. Article no. when ordered separately	Price See price list	Std. pack	Notes	Information relevant for export to North America	
					
NZM1-XKC 260015		1 set 	Standard connection with all NZM1, PN1 and N(S)1 switches. Conversion kit for circuit-breaker with screw terminal. Contains parts for a 3 or 4 pole switch side. Fitted within the switch housing. Use ferrules with flexible and highly flexible conductors. Max. cross section shown can only be connected when flexible and without ferrules.	Product Standards UL File No. UL CCN CSA File No. CSA Class No. NA Certification Suitable for	UL489; CSA-C22.2 No. 5-09; IEC60947, CE marking E31593 DIHS 022086 1437-01 UL Listed, CSA certified Refer to main component information
NZM1-4-XKC 267075		1 set		-	
NZM1-XKS 260019		1 set 	Contains parts for a terminal located at top or bottom for 3 or 4 pole circuit-breakers. Flush mounting outside the switch housing. Cover NZM1(-4)-XKSA must be fitted (included as standard).	Product Standards UL File No. UL CCN CSA File No. CSA Class No. NA Certification Suitable for	UL489; CSA-C22.2 No. 5-09; IEC60947, CE marking E31593 DIHS 022086 1437-01 UL Listed, CSA certified Refer to main component information
NZM1-4-XKS 266725		1 set		-	
NZM1-XKA 266730		1 set 	Contains parts for a terminal located at top or bottom for 3 or 4 pole switches. With control circuit terminal for 1 x 0.75 - 2.5 mm ² (18 - 14 AWG) or 2 x 0.75 - 1.5 mm ² (18 - 14 AWG) copper conductor. Flush mounting outside the switch housing. Use ferrules with flexible and highly flexible conductors. Max. cross section shown can only be connected when flexible and without ferrules. Cover NZM1(-4)-XKSA must be fitted (included as standard).	Product Standards UL File No. UL CCN CSA File No. CSA Class No. NA Certification Suitable for	UL489; CSA-C22.2 No. 5-09; IEC60947, CE marking E31593 DIHS 022086 1437-01 UL Listed, CSA certified Refer to main component information
NZM1-4-XKA 266731		1 set		-	
NZM1-XKR 266734		1 set	Contains parts for a terminal located at top or bottom for 3 or 4 pole switches.	-	
NZM1-4-XKR 266737		1 set		-	



	Max. cable connection area	Number of poles	For use with	Connection	Terminal capacity ¹⁾ mm ²	AWG/kcmil
Control cable terminals						
	–	3 and 4 pole	NZM1(-4), PN1(-4), N(S)1(-4)	Screw terminals	1 x 0.75-2.5 2 x 0.75-1.5	1 x 18-14 2 x 18-16
	–	3 and 4 pole	NZM1(-4), PN1(-4), N(S)1(-4)	Box terminal	1 x 0.75-2.5 2 x 0.75-1.5	1 x 18-14 2 x 18-16
Terminal covers knockout						
Not UL/CSA approved For box terminal						
	–	3 pole	NZM1, PN1, N1	–	–	–
	–	4 pole	NZM1-4, PN1-4, N1-4	–	–	–
Cover						
	–	3 pole	NZM1, PN1, N(S)1	–	–	–
	–	4 pole	NZM1-4, PN1-4, N1-4	–	–	–
IP2X protection against contact with finger						
For box terminal						
	–	3 pole	NZM1, PN1, N1	–	–	–
	–	4 pole	NZM1-4, PN1-4, N1-4	–	–	–
For covers NZM1(-4)-XKSA or NZM1...(C)NA, N(S)1...NA						
	–	3 pole	NZM1, PN1, NS1	–	–	–
	–	4 pole	NZM1-4, PN1-4, N1-4	–	–	–
Phase isolators						
	–	3 pole	NZM1, PN1, N(S)1	–	–	–
	–	4 pole	NZM1-4, PN1-4, N1-4	–	–	–

Part no. Article no. when ordered separately	Price See price list	Std. pack	Notes	Information relevant for export to North America	
					
NZM1-XSTS 260150		1 set 	Contains for two terminal locations located at top or bottom for 3 or 4 pole circuit-breakers. Included as standard with tunnel terminal. Degree of protection IP1X Height or thickness of connections: 2 mm	Product Standards	UL489; CSA-C22.2 No. 5-09; IEC60947, CE marking
NZM-XSTK 266739		1 set 	Contains for two terminal locations located at top or bottom for 3 or 4 pole circuit-breakers. cannot be combined with NZM1(-4)-XIPK IP2X protection against contact with a finger. Degree of protection IP1X Height or thickness of connections: 2 mm	UL File No. UL CCN CSA File No. CSA Class No. NA Certification	E140305 DIHS 022086 1437-01 UL Listed, CSA certified Refer to main component information
NZM1-XKSFA 100780		1 off	Contains parts for a terminal located at top or bottom for 3 or 4 pole switches.	UL/CSA certification not required	
NZM1-4-XKSFA 100781		1 off	Enhanced contact protection (simplified finger protection). Cannot be combined with NZM-XSTK control circuit terminal.	-	
NZM1-XKSA 260021		1 off 	Contains parts for a terminal located at top or bottom for 3 or 4 pole switches. Contact protection against direct contact where cable lugs, bars or tunnel terminals are used. Contained in the set with tunnel terminals and screw terminals. When using insulated conductor material to degree of protection IP1X.	Product Standards	UL489; CSA-C22.2 No. 5-09; IEC60947, CE marking
NZM1-4-XKSA 266741		1 off		UL File No. UL CCN CSA File No. CSA Class No. NA Certification	E31593 DIHS 022086 1437-01 UL Listed, CSA certified Refer to main component information
NZM1-XIPK 266744		1 set	Contains parts for a terminal located at top or bottom for 3 or 4 pole switches.	-	
NZM1-4-XIPK 266745		1 set	Enhanced contact protection to IP2X. Protection when reaching into the cable connection area with the connection of cables in the box terminal. Cannot be combined with NZM-XSTK control circuit terminal.	-	
NZM1-XIPA 266748		1 set 	Contains parts for a terminal located at top or bottom for 3 or 4 pole switches.	UL/CSA certification not required	
NZM1-4-XIPA 266749		1 set	Enhanced contact protection to IP2X.	-	
NZM1-XKP 119862		1 set 	Contains parts, including insulating plate for mounting plate, for a terminal located at top or bottom for 3 or 4 pole circuit-breakers. Insulation protection up to a rated operating voltage U _e of 415 V AC when minimum distances are not maintained.	UL/CSA certification not required	
NZM1-4-XKP 119863		1 set	Can not be combined with connection on rear NZM1(-4)-XKR.	-	



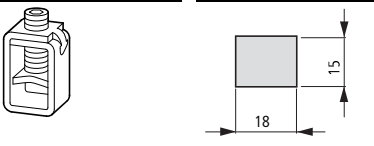
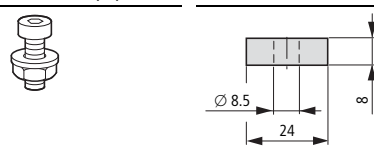
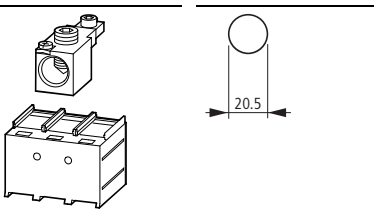
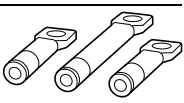



	Max. cable connection area	Number of poles	For use with	Terminal capacity		Terminal capacity		
				Cable lugs	Terminal capacity ¹⁾	AWG/kcmil	Copper strip No. of discs × width × disc thickness	Copper bar width × thickness
					mm ²		mm	mm
Box terminal								
		3 pole	NZM2, PN2, N(S)2 ≤ 160 A	Copper cable	1 x 10-185 2 x 4-70	1 x 12 - 350	≥ 2 x 9 x 0.8	-
			NZM2, PN2, N(S)2 > 160 A					
		4 pole	NZM2-4, PN2-4, N2-4 ≤ 160 A					
			NZM2-4, PN2-4, N2-4 > 160 A					
Screw terminals								
Standard equipment								
		3 pole	NZM2, PN2, N(S)2	Copper cable lugs Aluminium cable lugs	1 x 10 - 185 2 x 4 - 70 1 x 10 - 50 2 x 10 - 50	1 x 12 - 350	≥ 2 x 16 x 0.8	≥ 16 x 5
		4 pole	NZM2-4, PN2-4, N2-4					
Tunnel terminal								
		3 pole	NZM2, PN2, N(S)2	Copper cable Aluminium cable	1 x 16 - 185 1 x 16 - 185 Up to 240 mm ² can be connected depending on the cable manufacturer.	1 x 6 - 350	-	-
		4 pole	NZM2-4, PN2-4, N2-4					
Rear terminal bolts								
Not UL/CSA approved When using cable lugs without NZM3(-4)-XKSA cover, they must be insulated.								
		3 pole	NZM2, PN2, N2	Copper cable lugs Aluminium cable lugs	1 x 10 - 185 2 x 4 - 70 1 x 10 - 50 2 x 10 - 50	-	≥ 2 x 16 x 0.8 ≤ 6 x 24 x 0.5	≥ 16 x 5 ≥ 20 x 5
		4 pole	NZM2-4, PN2-4, N2-4					





Notes

¹⁾ Up to 240 mm² can be connected depending on the cable manufacturer.



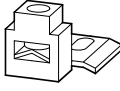
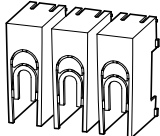
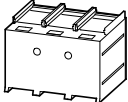
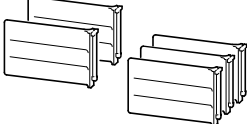
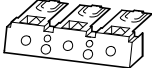





HPL17087EN

Part no. suffix Article no. for ordering with basic device	Price See price list	Part no. Article no. when ordered separately	Price See price list	Std. pack	Notes	Information relevant for export to North America	
							
+NZM2-160-XKCO 262218		NZM2-160-XKC 262240		1 set 	Part no. suffix and part no. contain parts for a circuit-breaker side at top or bottom for 3 or 4 pole switches. Conversion kit for circuit-breaker with screw terminal. Fitted within the switch housing. O = for fitting at the top U = for fitting at the bottom $U_e \geq 525$ V AC: Use NZM2(-4)-XKSA cover.	Product Standards UL489; CSA-C22.2 No. 5-09; IEC60947, CE marking UL File No. E31593 UL CCN DIHS CSA File No. 022086 CSA Class No. 1432-01 NA Certification UL Listed, CSA certified Suitable for Refer to main component information	
+NZM2-160-XKCU 262223		–	1 set 				
+NZM2-250-XKCO 262242		NZM2-250-XKC 262244		1 set			
+NZM2-250-XKCU 262243		–		1 set			
+NZM2-4-160-XKCO 266751		NZM2-4-160-XKC 266755		1 set			Use ferrules with flexible and highly flexible conductors. Max. cross section shown can only be connected when flexible and without ferrules.
+NZM2-4-160-XKCU 266753		–		1 set			
+NZM2-4-250-XKCO 266752		NZM2-4-250-XKC 266756		1 set			
+NZM2-4-250-XKCU 266754		–		1 set			
–		–		–			
–		NZM2-XKS 260030		1 set 	Contains parts for a terminal located at top or bottom for 3 or 4 pole switches. Standard connection with all NZM2, PN2 and N2 circuit-breakers. Conversion kit for circuit-breaker with box terminal. Use special cable lugs narrow version, → 17/88 Fitted within the switch housing. If a bar is used, insulation (400 mm) e.g. sleeving and a NZM2(-4)-XKSA cover are required. $U_e \geq 525$ V AC: With all other connection materials, e.g. cables and strips, use cover NZM2(-4)-XKSA.	Product Standards UL489; CSA-C22.2 No. 5-09; IEC60947, CE marking UL File No. E31593 UL CCN DIHS CSA File No. 022086 CSA Class No. 1432-01 NA Certification UL Listed, CSA certified Suitable for Refer to main component information	
–		NZM2-4-XKS 266750		1 set	–	–	
–		NZM2-XKA 271457		1 set 	Contains parts for a terminal located at top or bottom for 3 or 4 pole switches. With control circuit terminal for 1 x 0.75 - 2.5 mm ² (18 - 14 AWG) or 2 x 0.75 - 1.5 mm ² (18 - 16 AWG) copper conductor. Flush mounting outside the switch housing. Use ferrules with flexible and highly flexible conductors. Max. cross section shown can only be connected when flexible and without ferrules. Cover NZM2(-4)-XKSA must be fitted (included as standard).	Product Standards UL489; CSA-C22.2 No. 5-09; IEC60947, CE marking UL File No. E31593 UL CCN DIHS CSA File No. 022086 CSA Class No. 1432-01 NA Certification UL Listed, CSA certified Suitable for Refer to main component information	
–		NZM2-4-XKA 271458		1 set	–	–	
+NZM2-XKRO 266763		NZM2-XKR 266765		1 set	Part no. suffix and part no. contain parts for a circuit-breaker side at top or bottom for 3 or 4 pole switches. O = for fitting at the top U = for fitting at the bottom	–	
+NZM2-XKRU 266764		–		1 set			
+NZM2-4-XKRO 266766		NZM2-4-XKR 266768		1 set			
+NZM2-4-XKRU 266767		–		1 set			







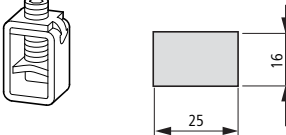
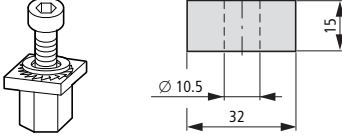
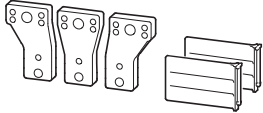
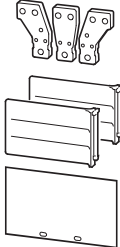
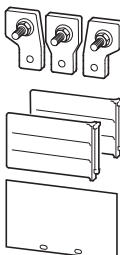

	Number of poles	For use with	Terminal capacity			Part no. suffix Article no. for ordering with basic device	Price See price list
			Connection	Terminal capacity ¹⁾ mm ²	AWG/kcmil		
Control cable terminals							
	3 and 4 pole	NZM2(-4), PN2(-4), N(S)2(-4)	Screw terminals	1 x 0.75 - 2.5 2 x 0.75 - 1.5	1 x 18 - 14 2 x 18 - 16	-	-
	3 and 4 pole	NZM2(-4), PN2(-4), N(S)2(-4)	Box terminal			-	-
Cable lug cover							
	3 pole	NZM2, PN2, NS2	Copper cable lugs	1 x 10-185 2 x 4-70	-	-	-
	4 pole	NZM2-4, PN2-4, N2-4	Aluminium cable lugs	1 x 10-50 2 x 10-50	-	-	-
Cover							
	3 pole	NZM2, PN2, NS2	-	-	-	-	-
	4 pole	NZM2-4, PN2-4, N2-4	-	-	-	-	-
Phase isolators							
	3 pole	NZM2, PN2, N(S)2	-	-	-	-	-
	4 pole	NZM2-4, PN2-4, N2-4	-	-	-	-	-
Terminal covers, knockout							
	3 pole	NZM2, PN2, N(S)2	-	-	-	+NZM2-XKSFAO 108269	-
			-	-	-	+NZM2-XKSFAU 108270	-
	4 pole	NZM2-4, PN2-4, N2-4	-	-	-	+NZM2-4-XKSFAO 108271	-
			-	-	-	+NZM2-4-XKSFAU 108272	-
IP2X protection against contact with finger							
For box terminal							
	3 pole	NZM2, PN2, N(S)2	-	-	-	-	-
	4 pole	NZM2-4, PN2-4, N2-4	-	-	-	-	-
For covers NZM2(-4)-XKSA or NZM2(-4) or NZM2...(C)NA and N(S)2...NA							
	3 pole	NZM2, PN2, N(S)2	-	-	-	-	-
	4 pole	NZM2-4, PN2-4, N2-4	-	-	-	-	-
Copper cable lug							
Not UL/CSA approved When using cable lugs without NZM3(-4)-XKSA cover, they must be insulated.							
	3 and 4 pole	NZM2(-4), PN2(-4), N2(-4)	-	150 mm ²	-	-	-
			-	120 mm ²	-	-	-
			-	95 mm ²	-	-	-
			-	185 mm ²	-	-	-

HPL17089EN





Part no. Article no. when ordered separately	Price See price list	Std. pack	Notes	Information relevant for export to North America
				
NZM2-XSTS 260156		1 set 	Contains parts for two terminal locations located at top or bottom for 3 or 4 pole switches. Included as standard with tunnel terminal. Degree of protection IP1X	Product Standards UL489; CSA-C22.2 No. 5-09; IEC60947, CE marking
NZM-XSTK 266739		1 set 	NZM-XSTK cannot be combined with NZM1(-4)-XIPK IP2X protection against contact with a finger. Height or thickness of connections: 2 mm	UL File No. E140305 UL CCN DIHS CSA File No. 022086 CSA Class No. 1437-01 NA Certification UL Listed, CSA certified Suitable for Refer to main component information
NZM2-XKSAE 119868		1 set 	Contains parts for a terminal located at top or bottom for 3 or 4 pole switches.	UL/CSA certification not required
NZM2-4-XKSAE 119870		1 set	Contact protection where cable lugs are used on screw terminals. When using insulated conductor material, degree of protection IP2X	-
NZM2-XKSA 260038		1 off 	Contains parts for a terminal located at top or bottom for 3 or 4 pole switches. Contact protection where cable lugs, bars or tunnel terminals are used. When using insulated conductor material, degree of protection IP1X	Product Standards UL489; CSA-C22.2 No. 5-09; IEC60947, CE marking
NZM2-4-XKSA 266770		1 off		UL File No. E31593 UL CCN DIHS CSA File No. 22086 CSA Class No. 1432-01 NA Certification UL Listed, CSA certified Suitable for Refer to main component information
NZM2-XKP 119864		1 set 	Contains parts, including insulating plate for mounting plate, for a terminal located at top or bottom for 3 or 4 pole circuit-breakers.	UL/CSA certification not required
NZM2-4-XKP 119865		1 set	Can not be combined with connection on rear NZM2(-4)-XKR. Insulation protection up to a rated operating voltage U_e of 415 V AC when minimum distances are not maintained.	-
NZM2-XKSFA 104640		1 off 	Contains parts for a terminal located at top or bottom for 3 or 4 pole switches.	UL/CSA certification not required
NZM2-4-XKSFA 104641		1 off	Enhanced contact protection (simplified finger protection). O = for fitting at the top U = for fitting at the bottom	
NZM2-XIPK 266773		1 set 	Contains parts for a terminal located at top or bottom for 3 or 4 pole switches.	UL/CSA certification not required
NZM2-4-XIPK 266774		1 set	Enhanced contact protection to IP2X. Protection on grasping terminal chamber when connecting cables in box terminals. With two conductors maximum cross-section 25 mm ² or AWG4. Can not be combined with control cable terminal NZM-XSTK.	-
NZM2-XIPA 266777		1 set 	Contains parts for a terminal located at top or bottom for 3 or 4 pole switches.	UL/CSA certification not required
NZM2-4-XIPA 266778		1 set	Enhanced contact protection to IP2X. When fitting to NZM2...-(C)NA or NZM...-NA: With 2 conductors maximum cross-section 25 mm ² or AWG4.	-
KS150-NZM7 059777		3 off	Contains a cable lug for 3 or 4 pole switch.	-
KS120-NZM7 059776			Special cable lug, narrow style	
KS95-NZM7 059775				
NZM2-XKS185 260032				



Max. cable connection area	Number of poles	For use with	Rated current ¹⁾ I_n A	Terminal capacity			Terminal capacity		
				Cable Cable lugs	Terminal capacities ¹⁾	AWG/kcmil	Copper strip No. of discs × width × disc thickness	Copper bar width × thickness	
									mm ²
Box terminal									
	3 pole	NZM3(-4), PN3(-4), N(S)3(-4)	max. 500 400 UL/ CSA	Copper cable Copper cable	1 x 35 - 240 2 x 16 - 120	1 x 2 - 350	min. 6 x 16 x 0.8 max. 10 x 24 x 1.0 or max. 11 x 21 x 1	—	
	4 pole		630	Copper cable	1 x 35 - 240 2 x 16 - 120	1 x 2 - 350	10 x 24 x 1.0 + 5 x 24 x 1.0 or (2 x) 8 x 24 x 1.0		
Screw connection, standard									
	3 pole	NZM3, PN3, N(S)3	630 Max. 400	Copper cable lugs Aluminium cable lugs	1 x 16 - 300 2 x 16 - 240 1 x 10 - 120 2 x 10 - 120	1 x 4 - 350 2 x 350 1 x 4 - 350 2 x 350	10 x 32 x 1.0 + 5 x 32 x 1.0	30 x 10 + 30 x 5	
	4 pole	NZM3-4, PN3-4, N(S)3-4							
Connection width extension									
One hole, for screws or terminals									
	3 pole	NZM3, PN3, N(S)3	630	Copper cable lugs Aluminium cable lugs	2 x 300	2 x 500	(2 x) 10 x 50 x 1.0	(2 x) 10 x 50	
	4 pole	NZM3-4, PN3-4, N3-4							
Two holes, for screws or terminals									
	3 pole	NZM3, PN3, N(S)3	630	Copper cable lugs	NZM3- XKV70-2: 4 x 35 - 185 NZM3- XKV70-2 + NZM4-XKA: 4 x 50 - 240	NZM3- XKV70-2: 2 x 350 NZM3- XKV70-2 + NZM4- XKA: 4 x 500	NZM3-XKV70-2 + NZM4-XKB: ≥ 6 x 16 - 0.8 ≤ (2 x) 10 x 32 x 1	(2 x) 10 x 50	
	4 pole	NZM3-4, PN3-4, N3-4							
One threaded stud									
	3 pole	NZM3, PN3, N(S)3	630	Copper cable lugs	2 x 95-300	2 x 500	(2x) 10 x 32 x 1.0	(2 x) 10 x 40	

Part no. suffix Article no. for ordering with basic device	Price See price list	Part no. Article no. when ordered separately	Price See price list	Std. pack	Notes	Information relevant for export to North America
						
+NZM3-XKCO 262246		NZM3-XKC 260042		1 set 	Part no. suffix and part no. contain parts for a circuit-breaker side at top or bottom for 3 or 4 pole switches. Conversion kit for circuit-breaker with screw terminal. Fitted within the switch housing. 0 = for fitting at the top U = for fitting at the bottom U _e ≥ 525 V AC. Use NZM3(-4)-XKSA cover. Use ferrules with flexible and highly flexible conductors. Observe limited cable cross-section through sleeve.	Product Standards UL489; CSA-C22.2 No. 5-09; IEC60947, CE marking UL File No. E31593 UL CCN DIHS CSA File No. 022086 CSA Class No. 1437-01 NA Certification UL Listed, CSA certified Suitable for Refer to main component information
+NZM3-XKCU 262245		-				
+NZM3-4-XKCO 266781		NZM3-4-XKC 266783		1 set		
+NZM3-4-XKCU 266782		-				
-	-	NZM3-XKS 260039		1 set 	Contains parts for a terminal located at top or bottom for 3 or 4 pole switches. Standard connection with all NZM3, PN3 and N3 circuit-breakers. Conversion kit for circuit-breaker with box terminal. Use special cable lugs narrow version, → 17/88 Fitted within the switch housing. If a bar is used, insulation (400 mm) heat-shrink tubing and a cover NZM3(-4)-XKSA are required. U _e ≥ 525 V AC. For all other connection types use cover NZM3(-4)-XKSA.	Product Standards UL489; CSA-C22.2 No. 5-09; IEC60947, CE marking UL File No. E31593 UL CCN DIHS CSA File No. 022086 CSA Class No. 1437-01 NA Certification UL Listed, CSA certified Suitable for Refer to main component information
-	-	NZM3-4-XKS 266780		1 set		
-	-	NZM3-XKV70 100514		1 set 	Contains parts for a terminal located at top or bottom for 3 or 4 pole switches. Central drilling for e.g. up to 2 cable lugs per phase. For fitting to switches with screw terminal. Phase isolator and insulation plate are included as standard. Distance between pole centres with NZM3(-4)-XKV70: 70 mm Hole for control wire exists. Connection terminals NZM3(-4)-XK300 and NZM3(-4)-XK22X21 can be installed.	Product Standards UL489; CSA-C22.2 No. 5-09; IEC60947, CE marking UL File No. E140305 UL CCN DIHS CSA File No. 022086 CSA Class No. 1432-01 NA Certification UL Listed, CSA certified
-	-	NZM3-4-XKV70 100515		1 set		
-	-	NZM3-XKV70-2 119860		1 set 	Contains parts for a terminal located at top or bottom for 3 pole circuit-breakers. Double hole fitting for up to four 185 mm ² cable lugs, 50 mm bbar or large flat cable terminal NZM4-XKB or large tunnel terminal NZM4-XKA For fitting to switches with screw terminal. Phase isolator, insulation plate and 2 control circuit terminals supplied.	Product Standards UL489; CSA-C22.2 No. 5-09; IEC60947, CE marking NA Certification Request filed for UL and CSA Suitable for Refer to main component information
-	-	NZM3-4-XKV70-2 132673				
-	-	NZM3-XKV70KB 112884		1 set 	Contains parts for a terminal located at top or bottom for 3 pole circuit-breakers. Threaded stud for cable lugs up to 2 × 300 mm ² For fitting to switches with screw terminal. Phase isolator, insulation plate and 2 control circuit terminals supplied.	

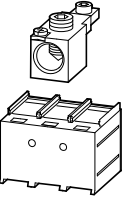
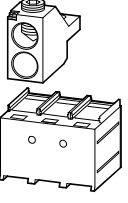
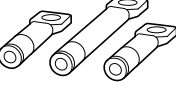

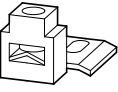



Max. cable connection area	Number of poles	For use with	Rated current ¹⁾ I _n A	Terminal capacity			Terminal capacity	
				Cable lugs	Terminal capacities ¹⁾ mm ²	AWG/kcmil	Copper strip No. of discs × width × disc thickness mm	Copper bar width × thickness mm
Terminals for connection width extension								
	3 pole	NZM3, PN3, N(S)3	Max. 500	Copper cable	1 x 120 - 300	—	—	—
	4 pole	NZM3-4, PN3-4, N3-4						
Not UL/CSA approved								
	3 pole	NZM3, PN3, N(S)3	630	—	—	—	(2 ×) 11 x 21 x 1.0	—
	4 pole	NZM3-4, PN3-4, N3-4						
Tunnel terminal								
	3 pole	NZM3, PN3, N(S)3	Max. 350	Copper cable ☺ ☹ Aluminium cable ☺ ☹	1 x 16 - 185	1 x 6 - 350	—	—
	4 pole	NZM3-4, PN3-4, N3-4						
	3 pole	NZM3, PN3, N(S)3	Max. 630	Copper cable ☺ ☹ Aluminium cable ☺ ☹	1 x 50-240 2 x 50-240	1 x 0-500 2 x 0-500	—	—
	4 pole	NZM3-4, PN3-4, N3-4						
Rear terminal bolts								
Not UL/CSA approved								
	3 pole	NZM3, PN3, N3	Max. 630 Max. 500	Copper cable lugs	1 x 16-240 2 x 16-240	—	min. 6 x 16 x 0.8 max. 10 x 32 x 1.0	min. 20 x 5 max. 30 - 10
	4 pole	NZM3-4, PN3-4, N3-4		Aluminium cable lugs	1 x 10-120 2 x 10-120			
Control cable terminals								
	3 and 4 pole	NZM3, PN3, N(S)3	—	Screw terminals	1 x 0.75-2.5 2 x 0.75-1.5	1 x 18-14 2 x 18-16	—	—
	3 and 4 pole	NZM3-4, PN3, N(S)3-4	—	Box terminal	1 x 0.75-2.5 2 x 0.75-1.5	1 x 18-14 2 x 18-16	—	—











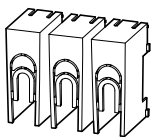

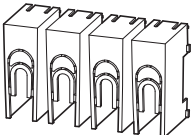
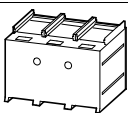

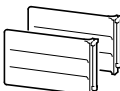

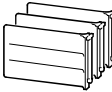
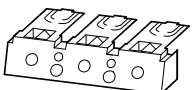
Notes

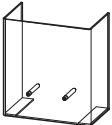
¹⁾ The rated operational current values have been determined according to IEC/EN 60947 (switchgear standard). They generally relate to the max. defined cross-sections and are intended as a general guide. The engineering standards which apply in each case must be observed.

HPL17093EN



Part no. suffix Article no. for ordering with basic device	Price See price list	Part no. Article no. when ordered separately	Price See price list	Std. pack	Notes	Information relevant for export to North America
						
-		NZM3-XK300 100782		1 set 	<p>Contains parts for a terminal located at top or bottom for 3 or 4 pole switches. Only in combination with connection width extension NZM3(-4)-XKV70. Use ferrules with flexible and highly flexible conductors. With control cable terminal for 1 × 0.75 – 2.5 mm² or 2 × 0.75 – 1.5 mm² copper conductor as standard.</p>	<p>Product Standards UL489; CSA-C22.2 No. 5-09; IEC60947, CE marking</p> <p>UL File No. E31593</p> <p>UL CCN DIHS</p> <p>CSA File No. 022086</p> <p>CSA Class No. 1432-01</p> <p>NA Certification UL Listed, CSA certified</p> <p>Suitable for Refer to main component information</p>
-		NZM3-4-XK300 100783		1 set		-
-		NZM3-XK22X21 100784		1 set		-
-		NZM3-4-XK22X21 100785		1 set		-
-		NZM3-XKA1²⁾ 271459		1 set	<p>Contains parts for a terminal located at top or bottom for 3 or 4 pole circuit-breakers. With control cable terminal for 1 × 0.75 – 2.5 mm² (18 – 14 AWG) or 2 × 0.75 – 1.5 mm² (18 – 16 AWG) copper cable as standard. Fitting outside switch housing. Use ferrules with flexible and highly flexible conductors. Max. cross section shown can only be connected when flexible and without ferrules. Cover NZM3(-4)-XKSA must be fitted (included as standard).</p>	-
-		NZM3-4-XKA1²⁾ 271460		1 set		-
-		NZM3-XKA2 271461		1 set 		<p>Product Standards UL489; CSA-C22.2 No. 5-09; IEC60947, CE marking</p> <p>UL File No. E31593</p> <p>UL CCN DIHS</p> <p>CSA File No. 022086</p> <p>CSA Class No. 1432-01</p> <p>NA Certification UL Listed, CSA certified</p> <p>Suitable for Refer to main component information</p>
-		NZM3-4-XKA2 271462		1 set	-	-
+NZM3-XKRO 266790		NZM3-XKR 266792		1 set	<p>Part no. suffix and part no. contain parts for a circuit-breaker side at top or bottom for 3 or 4 pole switches. O = for fitting at the top U = for fitting at the bottom</p>	-
+NZM3-XKRU 266791		-		1 set		-
+NZM3-4-XKRO 266793		NZM3-4-XKR 266795		1 set		-
+NZM3-4-XKRU 266794		-		1 set		-
-		NZM3/4-XSTS 266797		1 set 	<p>Contains for two terminal locations located at top or bottom for 3 or 4 pole circuit-breakers. Included as standard with tunnel terminal. Degree of protection IP1X Height or thickness of connections: 2 mm</p>	<p>Product Standards UL489; CSA-C22.2 No. 5-09; IEC60947, CE marking</p> <p>UL File No. E140305</p> <p>UL CCN DIHS</p> <p>CSA File No. 022086</p> <p>CSA Class No. 1437-01</p> <p>NA Certification UL Listed, CSA certified</p> <p>Suitable for Refer to main component information</p>
-		NZM-XSTK 266739		1 set 		<p>Contains for two terminal locations located at top or bottom for 3 or 4 pole circuit-breakers. Included as standard with tunnel terminal. Degree of protection IP1X NZM-XSTK cannot be combined with NZM1(-4)-XIPK IP2X protection against contact with a finger. Height or thickness of connections: 2 mm</p>







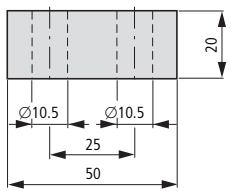
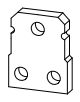
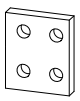
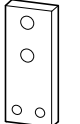

	Max. cable connection area	Number of poles	For use with	Part no. Article no. when ordered separately	Price See price list	Std. pack
Cable lug cover						
	-	3 pole	NZM3, PN3, N(S)3	NZM3-XKSAE 119869		1 set  
	-	4 pole	NZM3-4, PN3-4, N3-4	NZM3-4-XKSAE 119871		1 set
Cover						
	-	3 pole	NZM3, PN3, N(S)3	NZM3-XKSA 260045		1 off  
	-	4 pole	NZM3-4, PN3-4, N3-4	NZM3-4-XKSA 266801		1 off
Phase isolators						
	-	3 pole	NZM3, PN3, N(S)3	NZM3-XKP 100512		1 set  
	-	4 pole	NZM3-4, PN3-4, N3-4	NZM3-4-XKP 100513		1 set
Terminal covers, knockout						
	-	3 pole	NZM3, PN3, N(S)3	NZM3-XKSFA 104642		1 off  
	-	4 pole	NZM3-4, PN3-4, N3-4	NZM3-4-XKSFA 104643		1 off
Large cover for connection width extension						
	-	3 pole	NZM3, PN3, N3 + NZM3-XKV70(-2)	NZM3-XKSAV 119858		1 off
	-	4 pole	NZM3-4, PN3-4, N3-4 + NZM3-4-XKV70	NZM3-4-XKSAV 132675		1 off
IP2X protection against contact with finger						
For box terminal						
	-	3 pole	NZM3, PN3, N3	NZM3-XIPK 266804		1 set  
	-	4 pole	NZM3-4, PN3-4, N3-4	NZM3-4-XIPK 266805		1 set
For covers NZM3(-4)-XKSA or NZM3...(C)NA and N(S)3...NA						
	-	3 pole	NZM3, PN3, N(S)3	NZM3-XIPA 266808		1 set  
	-	4 pole	NZM3-4, PN3-4, N3-4	NZM3-4-XIPA 266809		1 set
Copper cable lug						
Not UL/CSA approved When using cable lugs without NZM3(-4)-XKSA cover, they must be insulated.						
	185 mm ²	3 and 4 pole	NZM3(-4), PN3(-4), N(S)3(-4)	NZM3-XKS185 260040		3 off
	240 mm ²			NZM3-XKS240 260041		3 off

Notes	Information relevant for export to North America														
<p>Contains parts for a terminal located at top or bottom for 3 or 4 pole switches. Contact protection where cable lugs are used on screw terminals. When using insulated conductor material, degree of protection IP2X.</p>	<p>UL/CSA certification not required</p>														
<p>Contains parts for a terminal located at top or bottom for 3 or 4 pole switches. Insulation/protection against direct contact where cable lugs, bars or tunnel terminals are used. Included in set with tunnel terminals. When using insulated conductor material to degree of protection IP1X.</p>	<table border="0"> <tr> <td>Product Standards</td> <td>UL489; CSA-C22.2 No. 5-09; IEC60947, CE marking</td> </tr> <tr> <td>UL File No.</td> <td>E31593</td> </tr> <tr> <td>UL CCN</td> <td>DIHS</td> </tr> <tr> <td>CSA File No.</td> <td>022086</td> </tr> <tr> <td>CSA Class No.</td> <td>1437-01</td> </tr> <tr> <td>NA Certification</td> <td>UL Listed, CSA certified</td> </tr> <tr> <td>Suitable for</td> <td>Refer to main component information</td> </tr> </table>	Product Standards	UL489; CSA-C22.2 No. 5-09; IEC60947, CE marking	UL File No.	E31593	UL CCN	DIHS	CSA File No.	022086	CSA Class No.	1437-01	NA Certification	UL Listed, CSA certified	Suitable for	Refer to main component information
Product Standards	UL489; CSA-C22.2 No. 5-09; IEC60947, CE marking														
UL File No.	E31593														
UL CCN	DIHS														
CSA File No.	022086														
CSA Class No.	1437-01														
NA Certification	UL Listed, CSA certified														
Suitable for	Refer to main component information														
<p>Contains parts, including insulating plate for mounting plate, for a terminal located at top or bottom for 3 or 4 pole circuit-breakers. Included with the connection width extension. Cannot be combined with the NZM3(-4)-XKA tunnel terminal, NZM3(-4)-XKR connection on rear. Insulation protection where cable lugs, bars, or flat conductor are used.</p>	<table border="0"> <tr> <td>Product Standards</td> <td>UL489; CSA-C22.2 No. 5-09; IEC60947, CE marking</td> </tr> <tr> <td>UL File No.</td> <td>E31593</td> </tr> <tr> <td>UL CCN</td> <td>DIHS</td> </tr> <tr> <td>CSA File No.</td> <td>022086</td> </tr> <tr> <td>CSA Class No.</td> <td>1432-01</td> </tr> <tr> <td>NA Certification</td> <td>UL Listed, CSA certified</td> </tr> <tr> <td>Suitable for</td> <td>Refer to main component information</td> </tr> </table>	Product Standards	UL489; CSA-C22.2 No. 5-09; IEC60947, CE marking	UL File No.	E31593	UL CCN	DIHS	CSA File No.	022086	CSA Class No.	1432-01	NA Certification	UL Listed, CSA certified	Suitable for	Refer to main component information
Product Standards	UL489; CSA-C22.2 No. 5-09; IEC60947, CE marking														
UL File No.	E31593														
UL CCN	DIHS														
CSA File No.	022086														
CSA Class No.	1432-01														
NA Certification	UL Listed, CSA certified														
Suitable for	Refer to main component information														
<p>Contains parts for a terminal located at top or bottom for 3 or 4 pole switches. Enhanced contact protection (simplified finger protection).</p>	<p>UL/CSA certification not required</p>														
<p>Contains parts for a terminal located at top or bottom for 3 pole circuit-breakers. Insulation protection/protection against direct contact for connection of cable lugs or bars to connection width extension. Can also be used for connection width extension NZM3-XKV70 with terminals NZM3-XK300, NZM3-XK22x21 or NZM4-XKA. When using insulated conductor material, degree of protection IP2X.</p>	<p>–</p>														
<p>Contains parts for a terminal located at top or bottom for 3 or 4 pole circuit-breakers. Enhanced contact protection to IP2X. Protection when reaching into the cable connection area with the connection of cables in the box terminal with 2 conductors max. cross section 70 mm². Cannot be combined with NZM-XSTK control circuit terminal.</p>	<p>UL/CSA certification not required</p>														
<p>Contains parts for a terminal located at top or bottom for 3 or 4 pole switches. Enhanced contact protection to IP2X. When fitting to NZM3...-(C)NA or N3...-NA: with 2 conductors max. cross section 70 mm².</p>	<p>UL/CSA certification not required</p>														
<p>The part no. contains a cable lug for 3 or 4 pole switch. Special cable lug, narrow style</p>	<p>–</p>														



	Space requirement	Rated current ¹⁾ I _n A	Number of poles	For use with	Terminal capacity			Terminal capacity		
					Cable lugs	Terminal capacity mm ²	AWG/kcmil	Copper strip No. of discs × width × disc thickness mm	Copper bar width × thickness mm	
Screw terminals										
Threaded stud standard equipment	2-hole 	Max. 1600	3 and 4 pole	NZM4(-4) N4(-4) N(S)4	Copper cable lugs	1 x 120-185 4 x 50-185	1 x 250-350 4 x 0-350	(2 x) 10 x 50 x 1.0	(2 x) 50 x 10	
Screws			3 pole	NZM4, N(S)4						
			4 pole	NZM4-4, N4-4						
Module plate										
	1-hole	-	Max. 1250	3 pole	NZM4, N(S)4	Copper cable lugs	1 x 120-300 2 x 95-300	1 x 250-600 2 x 000-600	(2 x) 10 x 40 x 1.0 (2 x) 10 x 50 x 1.0	(2 x) 40 x 10 (2 x) 50 x 10
			4 pole	NZM4-4, N4-4						
	2-hole	-	Max. 1400	3 pole	NZM4, N(S)4		2 x 95-185 4 x 35-185	2 x 000-350 4 x 2-350	(2 x) 10 x 50 x 1.0	(2 x) 50 x 10
		4 pole		NZM4-4, N4-4						
	2-hole	-	Max. 1250	3 pole	NZM4, N(S)4	Copper cable lugs	2 x 95-300	2 x 000-600	(2 x) 10 x 40 x 1.0 (2 x) 10 x 50 x 1.0	(2 x) 40 x 10 (2 x) 50 x 10
		4 pole		NZM4-4, N4-4						
	2-hole	-	Max. 1600	3 pole	NZM4, N(S)4					
		4 pole		NZM4-4, N4-4						

HPL17097EN



Part no. Article no. when ordered separately	Price See price list	Std. pack	Notes	Information relevant for export to North America
				
-			Double hole fitting with M10 threaded stud at 25 mm spacing. Use special cable lug narrow version.	-
NZM4-XKS 127736		1 set 	Double hole fitting with M10 screw at 25 mm spacing. Use special cable lug narrow version.	UL/CSA certification not required
NZM4-4-XKS 127737		1 set		-
NZM4-XKM1 266814		1 set 	Contains parts for a terminal located at top or bottom for 3 or 4 pole switches. For M10 screws. Can be enlarged for M12 screws. Use special cable lug narrow version. Can be fitted to circuit-breaker with screw terminal. Insulation using cover NZM4(-4)-XKSA or phase divider NZM4(-4)-XKP necessary.	Product Standards UL489; CSA-C22.2 No. 5-09; IEC60947, CE marking UL File No. E31593 UL CCN DIHS CSA File No. 22086 CSA Class No. 1432-01 NA Certification UL Listed, CSA certified Suitable for Refer to main component information
NZM4-4-XKM1 266815		1 set		-
NZM4-XKM2 266820		1 set 		Product Standards UL489; CSA-C22.2 No. 5-09; IEC60947, CE marking UL File No. E31593 UL CCN DIHS CSA File No. 22086 CSA Class No. 1432-01 NA Certification UL Listed, CSA certified Suitable for Refer to main component information
NZM4-4-XKM2 266821		1 set		-
NZM4-XKM2S-1250 284471		1 set 	Contains parts for a terminal located at top or bottom for 3 or 4 pole circuit-breakers. Insulation using cover NZM4(-4)-XKSA or phase divider NZM4(-4)-XKP necessary.	Product Standards UL489; CSA-C22.2 No. 5-09; IEC60947, CE marking UL File No. E31593 UL CCN DIHS CSA File No. 22086 CSA Class No. 1432-01 NA Certification UL Listed, CSA certified Suitable for Refer to main component information
NZM4-4-XKM2S-1250 284472		1 set		-
NZM4-XKM2S-1600 284473		1 set 		Product Standards UL489; CSA-C22.2 No. 5-09; IEC60947, CE marking UL File No. E31593 UL CCN DIHS CSA File No. 22086 CSA Class No. 1432-01 NA Certification UL Listed, CSA certified Suitable for Refer to main component information
NZM4-4-XKM2S-1600 284474		1 set		-

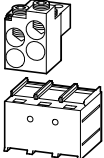
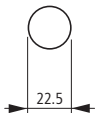
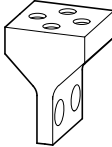

	Rated current ¹⁾ I_n	Number of poles	For use with	Terminal capacity		AWG/kcmil	Terminal capacity	
				Cable Cable lugs	Terminal capacity		Copper strip No. of discs x width x disc thickness	Copper bar width x thickness
	A				mm ²		mm	mm
Flat cable terminal								
	Max. 1100	3 pole	NZM4, N(S)4	–	–	–	min. 6 x 16 x 0.8 max. (2 x) 10 x 32 x 1.0	–
		4 pole	NZM4-4, N4-4	–	–	–	min. 6 x 16 x 0.8 max. (2 x) 10 x 32 x 1.0	–
Tunnel terminal								
 	Max. 1400	3 pole	NZM4, N(S)4	Copper cable ☺ ☻ Aluminium cable ☺ ☻	1 x 50-240 4 x 50-240	1 x 0-500 4 x 0-500	–	–
		4 pole	NZM4-4, N4-4	–	–	–	–	–
Rear terminal bolts								
Not UL/CSA approved								
	Max. 1250	3 pole	NZM4, N4	Copper cable lugs	1 x 120-185 2 x 95-185 4 x 35-185	–	(2 x) 10 x 50 x 1.0	(2 x) 50 x 10
		4 pole	NZM4(-4), N4(-4)	Aluminium cable lugs	1 x 185 2 x 70-185 4 x 50-185	–	–	–

Notes

¹⁾ The rated operational current values have been determined according to IEC/EN 60947 (switchgear standard). They generally relate to the max. defined cross-sections and are intended as a general guide. The engineering standards which apply in each case must be observed.

Part no. Article no. when ordered separately	Price See price list	Std. pack	Notes	Information relevant for export to North America 
NZM4-XKB 266829		1 set 	Contains parts for a terminal located at top or bottom for 3 or 4 pole switches. Conversion kit for circuit-breaker with screw terminal. Insulation using cover NZM4(-4)-XKSA or phase divider NZM4(-4)-XKP necessary. When the circuit-breaker is installed on a conductive mounting plate, cover NZM4(-4)-XKSA must be used With control circuit terminal for 1 x 0.75-2.5 mm ² or 2x 0.75-1.5 mm ² copper conductors as standard.	Product Standards UL489; CSA-C22.2 No. 5-09; IEC60947, CE marking NA Certification Request filed for UL and CSA
NZM4-4-XKB 266831		1 set		-
NZM4-XKA 266836		1 set 	Contains parts for a terminal located at top or bottom for 3 or 4 pole switches. With control circuit terminal for 1 x 0.75-2.5 mm ² (18-14 AWG) or 2 x 0.75-1.5 mm ² (18-16 AWG) copper cable as standard. Can be fitted to circuit-breaker with screw terminal. Use ferrules with flexible and highly flexible conductors. Cover NZM4(-4)-XKSA must be fitted (included as standard).	Product Standards UL489; CSA-C22.2 No. 5-09; IEC60947, CE marking UL File No. E31593 UL CCN DIHS CSA File No. 22086 CSA Class No. 1432-01 NA Certification UL Listed, CSA certified Suitable for Refer to main component information
NZM4-4-XKA 266837		1 set		-
NZM4-XKR 266842		1 set	Contains parts for a terminal located at top or bottom for 3 or 4 pole switches.	-
NZM4-4-XKR 266843		1 set	Can also be retrofitted: Module plate NZM4...-XKM... or connection width extension NZM4...-XKV...	-





Space requirement	Rated current ¹⁾ I_n A	Number of poles	For use with	Terminal capacity			Terminal capacity				
				Cable Cable lugs	Terminal capacity mm ²	AWG/kcmil	Copper strip No. of discs × width × disc thickness mm	Copper bar width × thickness mm			
Connection width extension											
					Max. 1600	3 pole	NZM4, N(S)4	Copper cable lugs 4 x 300 6 x 95-240	4 x 600 6 x 000-500	max. (2 x) 10 x 80 x 1.0	max. (2 x) 80 x 10
					Max. 1600	4 pole	NZM4-4, N4-4				
With two threaded studs											
					1600	3 pole	NZM4, N(S)4	Copper cable lugs 4 x 95-300	4 x 500	(2x) 10 x 80 x 1.0	(2 x) 10 x 80

Notes



¹⁾ The rated operational current values have been determined according to IEC/EN 60947 (switchgear standard). They generally relate to the max. defined cross-sections and are intended as a general guide. The engineering standards which apply in each case must be observed.



HPL17101EN

Part no. Article no. when ordered separately	Price See price list	Std. pack	Notes	Information relevant for export to North America
				
NZM4-XKV95 281591		1 set 	Contains parts for a terminal located at top or bottom for 3 or 4 pole switches. Five-hole fitting, for example, for up to nine cable lugs per phase. Can be fitted to circuit-breaker with screw terminal. Phase isolator supplied. Distance between pole centres with NZM4(-4)-XKV95: 95 mm Installation conditions for current transformer up to 130 mm width with 80 mm bar width. Distance between pole centers with NZM4-XKV110: 107.5 mm Installation conditions for current transformer up to 135 mm width with 80 mm bar width. Distance between pole centers with NZM4-4-XKV120: 122 mm Installation conditions for current transformer up to 164 mm width with 80 mm bar width. 4 mm holes predrilled for control cable terminal. NZM4-XKV95 contains hole for large cover NZM4-XKSAV.	Product Standards UL489; CSA-C22.2 No. 5-09; IEC60947, CE marking UL File No. E31593 UL CCN DIHS CSA File No. 022086 CSA Class No. 1432-01 NA Certification UL Listed, CSA certified Suitable for Refer to main component information
NZM4-XKV110 281593				
NZM4-4-XKV95 281592		1 set		
NZM4-4-XKV120 281594				
NZM4-XKV95-2KB 119861		1 set 	Contains parts for a terminal located at top or bottom for 3 pole circuit-breakers. Threaded stud for cable lugs up to 4 × 300 mm ² Can be fitted to circuit-breaker with screw terminal. Phase isolator, insulation plate and 2 control circuit terminals supplied.	Product Standards UL489; CSA-C22.2 No. 5-09; IEC60947, CE marking UL File No. E31593 UL CCN DIHS CSA File No. 022086 CSA Class No. 1432-01 NA Certification UL Listed, CSA certified Suitable for Refer to main component information

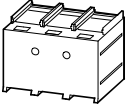
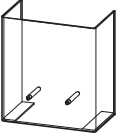
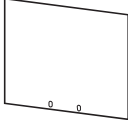
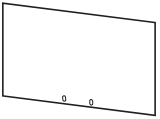
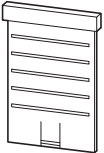
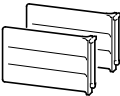
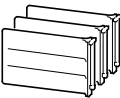





	Number of poles	For use with	Terminal capacity Connection	Terminal capacity mm ²	AWG/kcmil
Control cable terminals					
	3 and 4 pole	NZM3(-4), PN3, N(S)3(-4)	Screw terminals	1 x 0.75-2.5 2 x 0.75-1.5	1 x 18-14 2 x 18-16
Cover					
	3 pole	NZM4, N(S)4			
	4 pole	NZM4-4, N4-4			
Cover size					
For connection width extension					
	3 pole	NZM4, N(S)4 + NZM4-XKV95(KB)			
Insulation plate					
	3 pole	NZM4, N(S)4 + NZM4-XKV...			
	4 pole	NZM4(-4), N(S)4(-4) + NZM4-4-XKV...			
Terminal covers, knockout					
	3 pole	NZM4, N(S)4			
	4 pole	NZM4-4, N4-4			
Phase isolators					
	3 pole	NZM4 N(S)4			
	4 pole	NZM4-4, N4-4			
Cable lug					
Not UL/CSA approved When using cable lugs without NZM3(-4)-XKSA cover, they must be insulated.					
	3 and 4 pole	NZM4(-4), N(S)4(-4)		185 mm ²	
				240 mm ²	

HPL17103CH

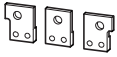
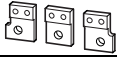
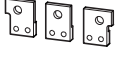

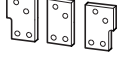
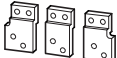
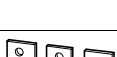
Part no. Article no. when ordered separately	Price See price list	Std. pack	Notes		Information relevant for export to North America
NZM3/4-XSTS 266797		1 off 	Contains parts for two terminal locations located at top or bottom for 3 or 4 pole circuit-breakers. Included as standard with tunnel terminal. Degree of protection IP1X Height or thickness of the control circuit terminals: NZM-XSTS = 2 mm		Product Standards UL489; CSA-C22.2 No. 5-09; IEC60947, CE marking E140305 UL File No. E31593 UL CCN DIHS CSA File No. 022086 CSA Class No. 1437-01 NA Certification UL Listed, CSA certified Suitable for Refer to main component information
NZM4-XKSA 266846		1 off 	Contains parts for a terminal located at top or bottom for 3 or 4 pole switches. Contact protection where cable lugs, bars, flat cable terminals or tunnel terminals are used. Included in set with tunnel terminals. When using insulated conductor material, degree of protection IP1X.		Product Standards UL489; CSA-C22.2 No. 5-09; IEC60947, CE marking E31593 UL File No. E31593 UL CCN DIHS CSA File No. 022086 CSA Class No. 1432-01 NA Certification UL Listed, CSA certified Suitable for Refer to main component information
NZM4-4-XKSA 266847		1 off			
NZM4-XKSAV 119876		1 off 	Contains parts for a terminal located at top or bottom for 3 pole circuit-breakers. Insulation protection/protection against direct contact for connection of cable lugs or bars to connection width extension. When using insulated conductor material, degree of protection IP2X.		UL/CSA certification not required
NZM4-XISP 119866		1 off 	Contains parts for a terminal located at top or bottom for 3 or 4 pole switches. Insulation protection when minimum distance from mounting plate not observed. Included with the connection width extension.		Product Standards UL489; CSA-C22.2 No. 5-09; IEC60947, CE marking NA Certification Request filed for UL and CSA Suitable for Refer to main component information
NZM4-4-XISP 119867		1 off			
NZM4-XKSFA 292193		1 off 	Contains parts for a terminal located at top or bottom for 3 or 4 pole switches. Increased contact protection with connection of insulated bars or flat band.		UL/CSA certification not required
NZM4-4-XKSFA 292194		1 off			
NZM4-XKP 281595		1 set 	Contains parts for a terminal located at top or bottom for 3 or 4 pole switches. Included with the connection width extension. Cannot be combined with tunnel terminal NZM4(-4)-XKA or rear connection NZM4-XKR. Insulation protection where cable lugs, bars, module plates or tunnel terminals are used.		Product Standards UL489; CSA-C22.2 No. 5-09; IEC60947, CE marking E31593 UL File No. E31593 UL CCN DIHS CSA File No. 022086 CSA Class No. 1432-01 NA Certification UL Listed, CSA certified Suitable for Refer to main component information
NZM4-4-XKP 281596		1 set			
NZM3-XKS185 260040		3 off	The part no. contains a cable lug for 3 or 4 pole switch. Special cable lug, narrow style		
NZM3-XKS240 260041					



	Rated current I_n A	For use with		Part no. Article no. when ordered separately	Price See price list	Std. pack	Notes
Adapter set N(ZM)4/N(ZM)12							
Not UL/CSA approved							
	Max. 1000	N4	3 pole	N4-XAS12-1000 285609		1 set	Conversion kit from N(ZM)12 to N(ZM)4. With the terminal lugs of the replacement kit all three-pole NZM12 and N12 can be adapted to the connection dimensions of the NZM4 or N4 supplied from model year 1983. 4 pole basic devices, withdrawable units and basic devices with remote operator can not be replaced.
	Max. 1250	N4	3 pole	N4-XAS12-1250 285610		1 set	Contents of replacement kits N(ZM)4-XAS12...: 3 connection extensions on outlet side 3 connection extensions on trip block side 2 mounting brackets 4 fixing screws
	Max. 1600	N4	3 pole	N4-XAS12-1600 285611		1 set	4 phase isolators 6 fixing screws, nuts and washers Paper drilling template in the instructional leaflet (AWA) The replacement kits have the same dimensions as models N(ZM)12..., which correspond to production status 02/97 to the present.
	Max. 1000	NZM4	3 pole	NZM4-XAS12-1000 285612		1 set	Special feature: Prior to 02/97 the N(ZM)12-800 was supplied with 10 mm instead of 8 mm terminal lugs. With these models the customer must determine the device's year of manufacture by measuring the thickness of the terminal lug and order replacement kit N(ZM)4-XAS12-1250.
	Max. 1250	NZM4	3 pole	NZM4-XAS12-1250 285613		1 set	Example: N(ZM)12-800...(1000) > N(ZM)4-XAS12-1000 N(ZM)12-800 before 02/97 > N(ZM)4-XAS12-1250 N(ZM)12-1250 > N(ZM)4-XAS12-1250 N(ZM)12-1600 > N(ZM)4-XAS12-1600
	Max. 1600	NZM4	3 pole	NZM4-XAS12-1600 285614		1 set	Addition for devices constructed prior to 1983! Here the replacement kit for switch-disconnectors can be used in full. For circuit-breakers with "long" ZM design, the adapter fit only at the top! At the bottom the devices are about 65 mm longer and the lower connection is about 26 mm deeper. Consequently the bottom adapters are too short and the heights do not correspond.
	Max. 1250	NZM4, N4	3 pole	NZM4-XAS14-1250 283291		1 set	Conversion kit for NZM14 to NZM4. Same connections as NZM14. Contains for both sides of switch. 3 connection extensions on outlet side 3 connection extensions on trip block side. 1 long shroud for the outlet side
	1600	NZM4, N4	3 pole	NZM4-XAS14-1600 283292		1 set	Paper drilling template in the instructional leaflet (AWA) Cannot be combined with the module plate (NZM4-XKM...), flat cable terminal (NZM4-XKB), connection width extension (NZM4-XKV...), tunnel terminal (NZM4-XKA), connection on rear (NZM4-XKR) and withdrawable unit (NZM4-XAV...).



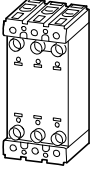



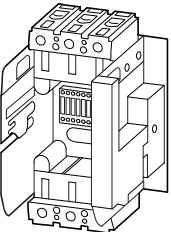
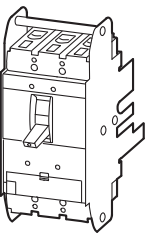

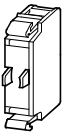

HPL17105EN

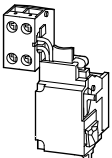
	For use with	Number of poles	Part no. Article no.	Price See Price List	Std. pack	Notes
Plug-in units						
For circuit-breakers NZM and switch-disconnectors N Not UL/CSA approved Not for $U_e > 690$ V						B = box terminals S = screw terminals For further terminal types see accessories
Plug-in socket						
	Completion through switches with plug-in insert NZM...-SVE...	NZM1 N1	3 pole	NZM1-XSVS 109777	B 1 off	I_{nmax} at: 20°C: 125 A (NZM1) 70°C: 100 A (NZM1) Mounting position: vertical, 90° right, 90° left Order control circuit plug unit separately!
		NZM2 N2	3 pole	NZM2-XSVS 266699	S 1 off	I_{nmax} at: 20°C: 250 A 40°C: 230 A (NZM...2-...) 250 A (NZM...2-E...) Mounting position: vertical, 90° right, 90° left Order control circuit plug unit separately!
		NZM2-4 N2-4	4 pole	NZM2-4-XSVS 266700	S 1 off	
Control circuit plug unit						
	-	NZM1, N1 NZM2(-4) N2(-4)	For auxiliary contact, shunt/over-voltage release	NZM2-XSVHI 266705	- 1 off	10 terminals
	-	NZM2(-4) N2(-4)	For remote operator	NZM2-XSVR 266706	- 1 off	

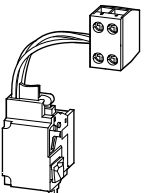
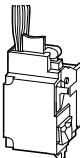
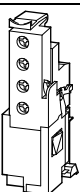
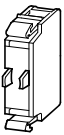





	For use with	Number of poles	Part no. suffix Article no. for order with basic device	Price See Price List	Std. pack	Part no. Article no. for separate order	Price See Price List	Std. pack	Notes
Withdrawable unit									
For circuit-breakers NZM and switch-disconnectors N Not UL/CSA approved Not for $U_e > 690$ V									
Socket base									
For switches with withdrawable carrier. Also for reserved compartments.									
	NZM3 N3	3 pole	-	-	-	NZM3-XAVS 266711	-	S 1 off	I_{nmax} at: 20 °C: 605 A (NZM3), 1600 A (NZM4) 40 °C: 550 A (NZM3), 1500 A (NZM4) Mounting position: NZM3: vertical, 90° left NZM4: vertical
	NZM3-4 N3-4	4 pole	-	-	-	NZM3-4-XAVS 266712	-	S 1 off	
	NZM4 N4	3 pole	-	-	-	NZM4-XAVS 266713	-	S 1 off	
	NZM4-4 N4-4	4 pole	-	-	-	NZM4-4-XAVS 266714	-	S 1 off	
Withdrawable carrier									
Suitable for socket base Only in combination with switch									
	NZM4 N4	3 pole	+NZM4-XAVE 266717	-	1 off	-	-	-	3 positions: Connected, test, disconnected Position indication is mechanical with pointers. Additional electrical indication with auxiliary contacts possible. One N/O or NC contact M22-(C)K01 or M22-(C)K10 each per position. Alternatively also double contacts M22-CK... Complete with control circuit plug unit. All auxiliary contact (HIA, HIN, HIV) and shunt release connections to the control circuit plug unit are already present. Maximum configuration: 3 contacts HIN, 2 contacts HIA, 2 contacts HIV Cannot be combined with adapter set NZM4/NZM14 (NZM4-XSAS14-...) or N(ZM)4/N(ZM)12.
	NZM4-4 N4-4	4 pole	+NZM4-4-XAVE 266718	-	1 off	-	-	-	



		For use with	Contact configuration: ☉ = safety function by positive opening according to IEC/EN 60947-5-1 N/O = normally open contact NC = normally closed contact	Contact sequences	Part no. Article no. when ordered separately	Price See price list	Std. pack
Auxiliary contacts							
Standard auxiliary contacts (HIN)¹⁾							
Switches with the main contacts. Used for indicating and interlocking tasks.							
	Single contact	NZM1(-4), 2(-4), 3(-4), 4(-4) PN1(-4), 2(-4), 3(-4) N(S)1(-4), 2(-4), 3(-4), 4(-4)	1 N/O	1 NC ☉	M22-K10 216376		20 off 
	Double contact	NZM1(-4), 2(-4), 3(-4), 4(-4) PN1(-4), 2(-4), 3(-4) N(S)1(-4), 2(-4), 3(-4), 4(-4)	1 N/O	1 NC ☉	M22-K01 216378		
			2 N/O	2 NC ☉			
Early-make auxiliary contact²⁾							
For interlocking and load shedding circuits, as well as for early make of the undervoltage release in main switch/emergency switching off applications							
	With clamp terminal on left switch side.	NZM1(-4) PN1(-4) N(S)1(-4)	2 N/O	-	NZM1-XHIV 259426		1 off 
	With clamp terminal on right switch side.		2 N/O	-	NZM1-XHIVR 292195		
	With 3 m connection cable instead of screw connection.		2 N/O	-	NZM1-XHIVL 259432		
	-	NZM2(-4), 3(-4) PN2(-4), 3(-4) N(S)2(-4), 3(-4)	2 N/O	-	NZM2/3-XHIV 259430		
		NZM4(-4) N(S)4(-4)	2 N/O	-	NZM4-XHIV 266172		
Trip indicating auxiliary contact (HIA), (HIAFI)¹⁾							
General trip indication "+", when tripped by shunt release, overload release, short-circuit release or earth-fault release due to fault current.							
	Single contact	NZM1(-4), 2(-4), 3(-4), 4(-4) PN1(-4), 2(-4), 3(-4) N(S)1(-4), 2(-4), 3(-4), 4(-4)	1 N/O	1 NC ☉	M22-K10 216376		20 off 
	Double contact	NZM1(-4), 2(-4), 3(-4), 4(-4) PN1(-4), 2(-4), 3(-4) N(S)1(-4), 2(-4), 3(-4), 4(-4)	1 N/O	1 NC ☉	M22-K01 216378		20 off 
			2 N/O	2 NC ☉			





HPL17107EN

Part no. Article no. when ordered separately	Price See price list	Std. pack	Notes	Notes
M22-CK10 216384		20 off 	The following applies for the std. pack: M22-(C)K... : Std. pack = 20 off	The following can be clipped into the switch: • NZM1: one standard auxiliary contact • NZM2: up to two standard auxiliary contacts M22-(C)K... • NZM3: up to three standard auxiliary contacts M22-(C)K... • NZM4: up to three standard auxiliary contacts M22-(C)K... Any combinations of the auxiliary contact types are possible. Marking on switch: HIN On combination with remote operator NZM-XR... the right mounting location of standard auxiliary contact HIN can be fitted only with individual contacts.
M22-CK01 216385				
M22-CK11 107940				
M22-CK02 107899				
M22-CK20 107898				
				Not in conjunction with undervoltage release NZM...-XU... or shunt release NZM...-XA... Early make with switch on and switch off (manual actuation): approx. 20 ms
				Not in conjunction with undervoltage release NZM...-XU..., shunt release NZM...-XA... or remote operator NZM...-XR... Early make (manual operation): approx. 20...90 ms
	M22-CK10 216384	20 off 	The following applies for the std. pack: M22-(C)K... : Std. pack = 20 off	The following can be clipped into the switch: • NZM1 - one trip-indicating auxiliary switch • NZM2 - one trip-indicating auxiliary switch M22-(C)K... • NZM3 - one trip-indicating auxiliary switch M22-(C)K... • NZM4 - up to two trip-indicating auxiliary switches M22-(C)K... Any combinations of the auxiliary contact types are possible. Not in combination with switch-disconnector PN... Marking on switch: HIA Labeling in residual-current block: HIAFI. If the trip-indicating auxiliary contacts are used in the residual-current block, the NC contacts operates as N/O contacts and the N/O contact operates as an NC contact.
	M22-CK01 216385	20 off 		
	M22-CK11 107940	20 off 		
	M22-CK02 107899	20 off 		
	M22-CK20 107898	20 off 		

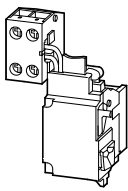

²⁾ Product Standards UL489; CSA-C22.2 No. 5-09; IEC60947, CE marking
UL File No. E140305
UL CCN DIHS

CSA File No. 022086
CSA Class No. 1437-01
NA Certification UL Listed, CSA certified

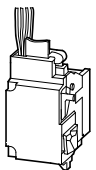

	For use with	Rated control voltage U_s V	Part no. Article no. for separate order	Price See price list	Std. pack	Notes
Undervoltage releases						
Without auxiliary contacts						
Non-delayed disconnection of circuit-breaker NZM or switch-disconnector N when control voltage drops below 35 – 70% U_s . For use with emergency switching off devices in conjunction with emergency switching off button.						
	With clamp terminal on left switch side.	NZM1(-4), N(S)1(-4)	24 V 50/60 Hz	NZM1-XU24AC 259434	1 off 	When the undervoltage release is de-energized, accidental contact with the main contacts of the switch during attempts to switch on is reliably prevented. Undervoltage releases cannot be installed simultaneously with early-make auxiliary contact NZM...-XHIV... or shunt release NZM...-XA...
			48 V 50/60 Hz	NZM1-XU48AC 259436		
			60 V 50/60 Hz	NZM1-XU60AC 259438		
			110 V-130 V 50/60 Hz	NZM1-XU110-130AC 259440		
			208 V-240 V 50/60 Hz	NZM1-XU208-240AC 259442		
			380 V-440 V 50/60 Hz	NZM1-XU380-440AC 259444		
			480 V-525 V 50/60 Hz	NZM1-XU480-525AC 259446		
			600 V 50/60 Hz	NZM1-XU600AC 259448		
			12 V DC	NZM1-XU12DC 259450		
			24 V DC	NZM1-XU24DC 259452		
			110 V-130 V DC	NZM1-XU110-130DC 259458		
			220 V-250 V DC	NZM1-XU220-250DC 259460		
				With 3 m connection cable instead of screw terminal.		
110 V-130 V 50/60 Hz	NZM1-XUL110-130AC 259468					
208 V-240 V 50/60 Hz	NZM1-XUL208-240AC 259471					
380 V-440 V 50/60 Hz	NZM1-XUL380-440AC 259473					
480 V-525 V 50/60 Hz	NZM1-XUL480-525AC 259475					
600 V 50/60 Hz	NZM1-XUL600AC 259477					
12 V DC	NZM1-XUL12DC 259479					
24 V DC	NZM1-XUL24DC 259481					
110 V-130 V DC	NZM1-XUL110-130DC 259487					
220 V-250 V DC	NZM1-XUL220-250DC 259489					

Information relevant for export to North America

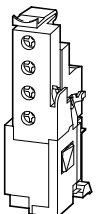

Product Standards UL489; CSA-C22.2 No. 5-09; IEC60947, CE marking
 UL File No. E140305
 UL CCN DIHS
 CSA File No. 022086
 CSA Class No. 1437-01
 NA Certification UL Listed, CSA certified

HPL17109EN

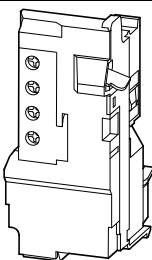





For use with	Rated control voltage U _s V	Part no. Article no. when ordered separately	Price See price list	Std. pack	Notes
Undervoltage releases					
Without auxiliary contacts					
Non-delayed disconnection of circuit-breaker NZM or switch-disconnector N when control voltage drops below 35 – 70% U _s . For use with emergency switching off devices in conjunction with emergency switching off button					
	NZM2(-4), N(S)2(-4) NZM3(-4), N(S)3(-4)	24 V 50/60 Hz	NZM2/3-XU24AC 259491	1 off 	When the undervoltage release is de-energized, accidental contact with the main switches of the switch during attempts to switch on is reliably prevented. Undervoltage release cannot be installed simultaneously with early-make auxiliary contact NZM...-XHIV... or undervoltage release NZM...-XA...
		48 V 50/60 Hz	NZM2/3-XU48AC 259493		
		60 V 50/60 Hz	NZM2/3-XU60AC 259495		
		110 V-130 V 50/60 Hz	NZM2/3-XU110-130AC 259497		
		208 V-240 V 50/60 Hz	NZM2/3-XU208-240AC 259499		
		380 V-440 V 50/60 Hz	NZM2/3-XU380-440AC 259501		
		480 V-525 V 50/60 Hz	NZM2/3-XU480-525AC 259503		
		600 V 50/60 Hz	NZM2/3-XU600AC 259505		
		12 V DC	NZM2/3-XU12DC 259507		
		24 V DC	NZM2/3-XU24DC 259509		
		110 V-130 V DC	NZM2/3-XU110-130DC 259515		
		220 V-250 V DC	NZM2/3-XU220-250DC 259517		
		NZM4(-4), N(S)4(-4)	24 V 50/60 Hz		
		48 V 50/60 Hz	NZM4-XU48AC 266190		
		60 V 50/60 Hz	NZM4-XU60AC 266191		
		110 V-130 V 50/60 Hz	NZM4-XU110-130AC 266192		
		208 V-240 V 50/60 Hz	NZM4-XU208-240AC 266193		
		380 V-440 V 50/60 Hz	NZM4-XU380-440AC 266194		
		480 V-525 V 50/60 Hz	NZM4-XU480-525AC 266195		
		600 V 50/60 Hz	NZM4-XU600AC 266196		
		12 V DC	NZM4-XU12DC 266203		
		24 V DC	NZM4-XU24DC 266204		
		110 V-130 V DC	NZM4-XU110-130DC 266207		
		220 V-250 V DC	NZM4-XU220-250DC 266208		

Information relevant for export to North America

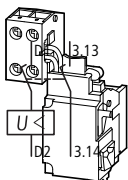

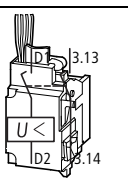
Product Standards UL489; CSA-C22.2 No. 5-09; IEC60947, CE marking
 UL File No. E140305
 UL CCN DIHS
 CSA File No. Q22086
 CSA Class No. 1437-01
 NA Certification UL Listed, CSA certified

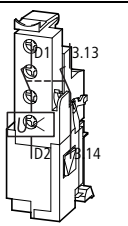







	For use with	Rated control voltage U_s V	Part no. Article no. for separate order	Price See price list	Std. pack	Notes				
Undervoltage releases										
With two early-make auxiliary contacts										
For interlocking and load-shedding circuits, as well as for early-make of the undervoltage release in main-switch applications. For use with emergency switching off devices in conjunction with emergency switching off button.										
 <p>With clamp terminal on left switch side.</p>	NZM1(-4), N(S)1(-4)	24 V 50/60 Hz	NZM1-XUHIV24AC 259531		1 off 	When the undervoltage release is de-energized, accidental contact with the main contacts of the switch during attempts to switch on is reliably prevented. Early-make of auxiliary contacts on switching on and off (manual operation): approx. 20 ms Undervoltage releases cannot be installed simultaneously with early-make auxiliary contact NZM...-XHIV... or shunt release NZM...-XA....				
		48 V 50/60 Hz	NZM1-XUHIV48AC 259533							
		60 V 50/60 Hz	NZM1-XUHIV60AC 259535							
		110 V-130 V 50/60 Hz	NZM1-XUHIV110-130AC 259537							
		208 V-240 V 50/60 Hz	NZM1-XUHIV208-240AC 259539							
		380 V-440 V 50/60 Hz	NZM1-XUHIV380-440AC 259541							
		480 V-525 V 50/60 Hz	NZM1-XUHIV480-525AC 259543							
		12 V DC	NZM1-XUHIV12DC 259545							
		24 V DC	NZM1-XUHIV24DC 259547							
		110 V-130 V DC	NZM1-XUHIV110-130DC 259553							
		220 V-250 V DC	NZM1-XUHIV220-250DC 259555							
		 <p>With 3 m connection cable instead of screw connection.</p>	NZM1(-4), N(S)1(-4)	24 V 50/60 Hz			NZM1-XUHIVL24AC 259557		1 off 	
110 V-130 V 50/60 Hz	NZM1-XUHIVL110-130AC 259563									
208 V-240 V 50/60 Hz	NZM1-XUHIVL208-240AC 259565									
380 V-440 V 50/60 Hz	NZM1-XUHIVL380-440AC 259567									
480 V-525 V 50/60 Hz	NZM1-XUHIVL480-525AC 259569									
12 V DC	NZM1-XUHIVL12DC 259571									
24 V DC	NZM1-XUHIVL24DC 259573									
110 V-130 V DC	NZM1-XUHIVL110-130DC 259579									
220 V-250 V DC	NZM1-XUHIVL220-250DC 259581									
	NZM2(-4), N(S)2(-4) NZM3(-4), N(S)3(-4)			24 V 50/60 Hz	NZM2/3-XUHIV24AC 259583		1 off 	When the undervoltage release is de-energized, accidental contact with the main contacts of the switch during attempts to switch on is reliably prevented. Early-make of auxiliary contacts on switching on and off (manual operation): approx. 20 ms Cannot be used in conjunction with remote operator NZM...-XR... Undervoltage releases cannot be installed simultaneously with early-make auxiliary contact NZM...-XHIV... or shunt release NZM...-XA....		
				48 V 50/60 Hz	NZM2/3-XUHIV48AC 259585					
				60 V 50/60 Hz	NZM2/3-XUHIV60AC 259587					
		110 V-130 V 50/60 Hz	NZM2/3-XUHIV110-130AC 259589							
		208 V-240 V 50/60 Hz	NZM2/3-XUHIV208-240AC 259591							
		380 V-440 V 50/60 Hz	NZM2/3-XUHIV380-440AC 259594							
		480 V-525 V 50/60 Hz	NZM2/3-XUHIV480-525AC 259598							
		12 V DC	NZM2/3-XUHIV12DC 259600							
		24 V DC	NZM2/3-XUHIV24DC 259602							
		110 V-130 V DC	NZM2/3-XUHIV110-130DC 259608							
		220 V-250 V DC	NZM2/3-XUHIV220-250DC 259610							

Information relevant for export to North America

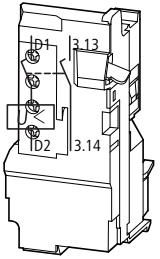

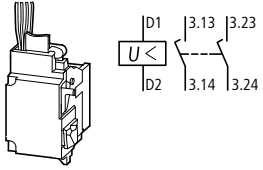
Product Standards UL489; CSA-C22.2 No. 5-09; IEC60947, CE marking
 UL File No. E140305
 UL CCN DIHS
 CSA File No. 022086
 CSA Class No. 1437-01
 NA Certification UL Listed, CSA certified

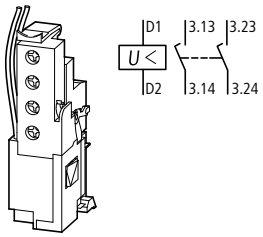
HPL17111EN







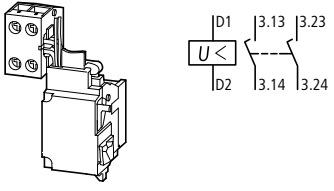

For use with	Rated operating voltage U_s V	Part no. Article no. when ordered separately	Price See price list	Std. pack	Notes
Undervoltage releases					
With two early-make auxiliary contacts					
For interlocking and load-shedding circuits, as well as for early-make of the undervoltage release in main-switch applications. For use with emergency switching off devices in conjunction with emergency switching off button.					
	NZM4(-4), N(S)4(-4)	24 V 50/60 Hz	NZM4-XUHIV24AC 266217	1 off 	When the undervoltage release is de-energized, accidental contact with the main contacts of the switch during attempts to switch on is reliably prevented. Early make of auxiliary contacts on switching on (manual operation): approx. 90 ms Cannot be used in conjunction with remote operator NZM...-XR... Undervoltage release cannot be installed together with early-make auxiliary contact NZM...-XHIV... or shunt release NZM...-XA...
		48 V 50/60 Hz	NZM4-XUHIV48AC 266218		
		60 V 50/60 Hz	NZM4-XUHIV60AC 266219		
		110 V-130 V 50/60 Hz	NZM4-XUHIV110-130AC 266220		
		208 V-240 V 50/60 Hz	NZM4-XUHIV208-240AC 266221		
		380 V-440 V 50/60 Hz	NZM4-XUHIV380-440AC 266222		
		480 V-525 V 50/60 Hz	NZM4-XUHIV480-525AC 266223		
		12 V DC	NZM4-XUHIV12DC 266231		
		24 V DC	NZM4-XUHIV24DC 266232		
		110 V-130 V DC	NZM4-XUHIV110-130DC 266235		
	220 V-250 V DC	NZM4-XUHIV220-250DC 266236			
With 2 separate early-make auxiliary contacts					
With 3 m connection cable instead of screw terminal.					
	NZM1(-4), N(S)1(-4)	24 V 50/60 Hz	NZM1-XUHIV20L24AC 259612	1 off 	When the undervoltage release is de-energized, accidental contact with the main switches of the switch during attempts to switch on is safely prevented. Early make of auxiliary contacts on switching on and off (manual operation): approx. 20 ms Cannot be used in conjunction with remote operator NZM...-XR... Undervoltage release cannot be installed simultaneously with early-make auxiliary contact NZM...-XHIV... or shunt release NZM...-XA...
		110 V-130 V 50/60 Hz	NZM1-XUHIV20L110-130AC 259620		
		208 V-240 V 50/60 Hz	NZM1-XUHIV20L208-240AC 259622		
		380 V-440 V 50/60 Hz	NZM1-XUHIV20L380-440AC 259624		
		24 V DC	NZM1-XUHIV20L24DC 259630		
Contacts 3.23 and 3.24 with separate 3 m connection cables.					
	NZM2(-4), N(S)2(-4)	24 V 50/60 Hz	NZM2/3-XUHIV2024AC 259640	1 off 	
	NZM3(-4), N(S)3(-4)	110 V-130 V 50/60 Hz	NZM2/3-XUHIV20110-130AC 259648		
		208 V-240 V 50/60 Hz	NZM2/3-XUHIV20208-240AC 259651		
		380 V-440 V 50/60 Hz	NZM2/3-XUHIV20380-440AC 259653		
		24 V DC	NZM2/3-XUHIV2024DC 259659		

Information relevant for export to North America

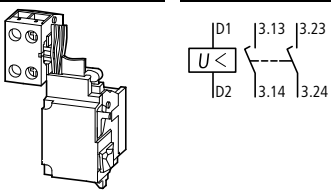

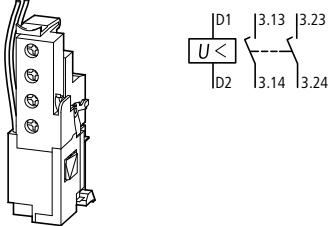
Product Standards UL489; CSA-C22.2 No. 5-09; IEC60947, CE marking
 UL File No. E140305
 UL CCN DIHS
 CSA File No. Q22086
 CSA Class No. 1437-01
 NA Certification UL Listed, CSA certified

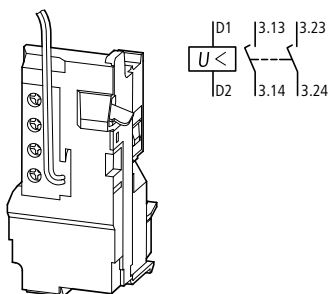

	For use with	Rated control voltage U_s V	Part no. Article no. when ordered separately	Price See price list	Std. pack	Notes
Undervoltage releases						
With 2 separate early-make auxiliary contacts For use with emergency switching off devices in conjunction with emergency switching off button.						
Coil connections wired to clamp terminals, auxiliary contact connections with 3 m loose connection cables.						
	NZM1(-4), N(S)1(-4)	24 V 50/60 Hz	NZM1-XUHIV20KL24AC 284388		1 off 	When the undervoltage release is de-energized, accidental contact with the main contacts of the switch during attempts to switch on is reliably prevented.
		110 V-130 V 50/60 Hz	NZM1-XUHIV20KL110-130AC 284389			
		208 V-240 V 50/60 Hz	NZM1-XUHIV20KL208-240AC 284400			
		24 V DC	NZM1-XUHIV20KL24DC 284387			
Coil connections with 3 m loose connection cables, auxiliary contact connections wired to clamp terminals.						
	NZM1(-4), N(S)1(-4)	24 V 50/60 Hz	NZM1-XUHIV20LK24AC 284402		1 off 	Early make of auxiliary contacts on switching on and off (manual operation): approx. 20 ms
		110 V-130 V 50/60 Hz	NZM1-XUHIV20LK110-130AC 284403			
		208 V-240 V 50/60 Hz	NZM1-XUHIV20LK208-240AC 284404			
		24 V DC	NZM1-XUHIV20LK24DC 284401			
	NZM2(-4), N(S)2(-4), NZM3(-4), N(S)3(-4)	24 V 50/60 Hz	NZM2/3-XUHIV20LK24AC 285291		1 off 	Undervoltage release cannot be installed simultaneously with early-make auxiliary contact NZM...-XHIV... or shunt release NZM...-XA...
		110 V-130 V 50/60 Hz	NZM2/3-XUHIV20LK110-130AC 284407			
		208 V-240 V 50/60 Hz	NZM2/3-XUHIV20LK208-240AC 284408			
		24 V DC	NZM2/3-XUHIV20LK24DC 284405			
Contacts 3.23 and 3.24 with separate 3 m connection cables.						
	NZM4(-4), N(S)4(-4)	24 V 50/60 Hz	NZM4-XUHIV2024AC 266244		1 off 	
		110 V-130 V 50/60 Hz	NZM4-XUHIV20110-130AC 266247			
		208 V-240 V 50/60 Hz	NZM4-XUHIV20208-240AC 266248			
		380 V-440 V 50/60 Hz	NZM4-XUHIV20380-440AC 266249			
		24 V DC	NZM4-XUHIV2024DC 266258			



Information relevant for export to North America







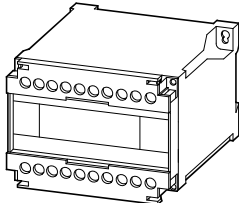

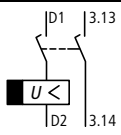
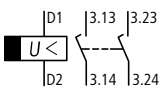

Product Standards
UL File No.
UL CCN
CSA File No.
CSA Class No.
NA Certification

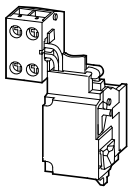
UL489; CSA-C22.2 No. 5-09; IEC60947, CE marking
E140305
DIHS
022086
1437-01
UL Listed, CSA certified

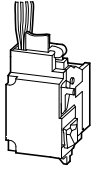
HPL17113EN

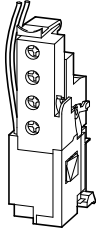
For use with	Part no. Article no. when ordered separately	Price See price list	Std. pack	Notes
Undervoltage releases, off-delayed				
Combination of separate delay unit and special releases. For use with emergency switching off devices in conjunction with emergency switching off button. Not UL/CSA approved				
Delay unit				
Voltage dips of less than 0.06 – 16 s do not cause disconnection of the NZM circuit-breaker or N switch-disconnector.				
	NZM1(-4), 2(-4), 3(-4), 4(-4) N(S)1(-4), 2(-4), 3(-4), 4(-4)	UVU-NZM 260154	1 off	Delay time can be set from 70 ms – 4 s. With additional external capacitor: <ul style="list-style-type: none"> • 30,000 µF ≥ 35 V up to 8 s • 90,000 µF ≥ 35 V up to 16 s A special release is required. Cannot be installed simultaneously with early-make auxiliary contact NZM...-XHIV... or shunt release NZM...-XA... Delay unit for separate installation (mounting: top-hat rail or screws). For other operating voltages use a control transformer.
	50/60 Hz 220 V-240 V 380 V-440 V 480 V-550 V			
	DC/AC 24 V			
Special trip block				
For combination with separate delay unit				
Without auxiliary contacts				
NZM1 with 3 m loose connection cables instead of screw terminal, NZM2, 3, and 4 with screw terminals				
	NZM1(-4) N(S)1(-4)	NZM1-XUVL 271607	1 off	Delay unit UVU-NZM is additionally required. Cannot be installed simultaneously with separate early-make auxiliary contact NZM...-XHIV... or shunt release NZM...-XA...
	NZM2(-4), N(S)2(-4) NZM3(-4), N(S)3(-4)	NZM2/3-XUV 259527		
	NZM4(-4) N(S)4(-4)	NZM4-XUV 266588		
With two early-make auxiliary contacts				
	NZM1(-4) N(S)1(-4)	NZM1-XUVHIVL 271608	1 off	Cannot be used in conjunction with remote operator NZM...-XR... Delay unit UVU-NZM is additionally required. Cannot be installed simultaneously with separate early-make auxiliary contact NZM...-XHIV... or shunt release NZM...-XA... NZM1, 2, 3: Early make of auxiliary contacts on switching on and off (manual operation): approx. 20 ms. NZM4: Early make of auxiliary contacts on switching on (manual operation): approx. 90 ms.
	NZM2(-4), N(S)2(-4) NZM3(-4), N(S)3(-4)	NZM2/3-XUVHIV 259684		
	NZM4(-4) N(S)4(-4)	NZM4-XUVHIV 266596		
With two independently operating early-make auxiliary contacts				
NZM1 with 3 m separate connection cables instead of screw terminal, NZM2, 3, 4 with screw terminal, contact 3.23 and 3.24 with 3 m separate connection cables.				
	NZM1(-4) N(S)1(-4)	NZM1-XUVHIV20L 271609	1 off	
	NZM2(-4), N(S)2(-4) NZM3(-4), N(S)3(-4)	NZM2/3-XUVHIV20 259688		
	NZM4(-4) N(S)4(-4)	NZM4-XUVHIV20 266604		

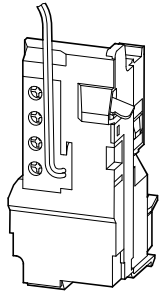

	For use with	Rated control voltage U_s V	Part no. Article no. when ordered separately	Price See price list	Std. pack	Notes		
Shunt releases								
Without auxiliary contacts								
Switches are tripped by a voltage pulse or by the application of uninterrupted voltage.								
 	With clamp terminal on left switch side.	NZM1(-4), N(S)1(-4)	12 V AC/DC	NZM1-XA12AC/DC 259706	1 off 	When the shunt release is live, contact with the switch's main contacts on switching on is reliably prevented. Undervoltage releases cannot be installed simultaneously with early-make auxiliary contact NZM...-XHIV... or shunt release NZM...-XU...		
		24 V AC/DC	NZM1-XA24AC/DC 259708					
		48 V AC/DC	NZM1-XA48AC/DC 259720					
		60 V AC/DC	NZM1-XA60AC/DC 259722					
		110 V-130 V AC/DC	NZM1-XA110-130AC/DC 259724					
		208 V-250 V AC/DC	NZM1-XA208-250AC/DC 259726					
		380 V-440 V AC/DC	NZM1-XA380-440AC/DC 259728					
 	With 3 m connection cable instead of screw terminal.	NZM1(-4), N(S)1(-4)	12 V AC/DC	NZM1-XAL12AC/DC 259734	1 off 			
		24 V AC/DC	NZM1-XAL24AC/DC 259736					
		110 V-130 V AC/DC	NZM1-XAL110-130AC/DC 259742					
		208 V-250 V AC/DC	NZM1-XAL208-250AC/DC 259744					
		380 V-440 V AC/DC	NZM1-XAL380-440AC/DC 259746					
		 	With 3 m connection cable instead of screw terminal.	NZM2(-4), N(S)2(-4) NZM3(-4), N(S)3(-4)		12 V AC/DC	NZM2/3-XA12AC/DC 259752	1 off 
				24 V AC/DC		NZM2/3-XA24AC/DC 259754		
48 V AC/DC	NZM2/3-XA48AC/DC 259756							
60 V AC/DC	NZM2/3-XA60AC/DC 259758							
110 V-130 V AC/DC	NZM2/3-XA110-130AC/DC 259760							
208 V-250 V AC/DC	NZM2/3-XA208-250AC/DC 259763							
380 V-440 V AC/DC	NZM2/3-XA380-440AC/DC 259766							
 	With 3 m connection cable instead of screw terminal.	NZM4(-4), N(S)4(-4)	12 V AC/DC	NZM4-XA12AC/DC 266446	1 off 			
		24 V AC/DC	NZM4-XA24AC/DC 266447					
		48 V AC/DC	NZM4-XA48AC/DC 266448					
		60 V AC/DC	NZM4-XA60AC/DC 266449					
		110 V-130 V AC/DC	NZM4-XA110-130AC/DC 266450					
		208 V-250 V AC/DC	NZM4-XA208-250AC/DC 266451					
		380 V-440 V AC/DC	NZM4-XA380-440AC/DC 266452					







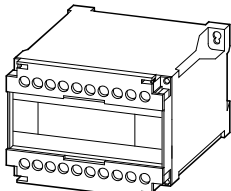

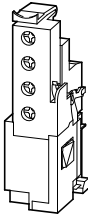
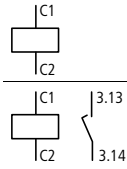
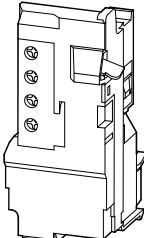
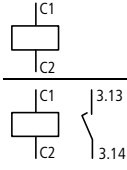
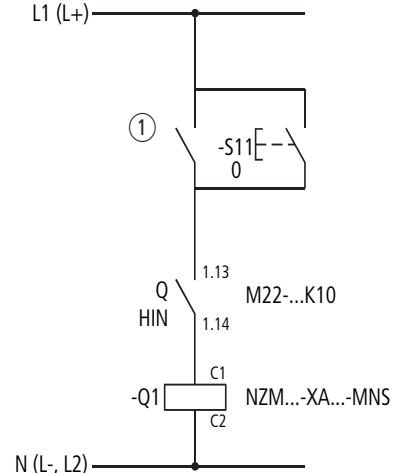
Information relevant for export to North America

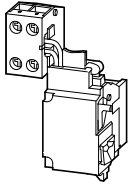
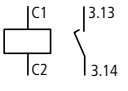

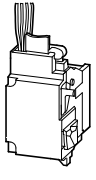
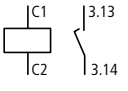
Product Standards UL489; CSA-C22.2 No. 5-09; IEC60947, CE marking
 UL File No. E140305
 UL CCN DIHS
 CSA File No. 022086
 CSA Class No. 1437-01
 NA Certification UL Listed, CSA certified

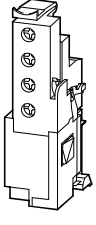
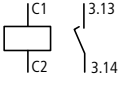
For use with	Part no. Article no.	Price See price list	Std. pack	Notes
With screw terminal				
With screw terminal				
Shunt releases				
Capacitor unit 230 V 50/60 Hz in conjunction with shunt release NZM...-XA208-250 AC/DC Enclosure: degree of protection IP20 Not UL/CSA approved				Enables the reliable use of circuit-breakers as mesh network circuit-breakers in the range from 0 – 110 % U_n with constant switch-off time of 40 ms. If the mains voltage is absent, the installed capacitor supplies power for actuating the shunt release for at least 12 hours. The capacitor unit is arranged independently of the circuit-breaker. Connect NZM-XCM to the power feed side.
 NZM1(-4), N(S)1(-4) NZM2(-4), N(S)2(-4) NZM3(-4), N(S)3(-4) NZM4(-4), N(S)4(-4)	NZM-XCM 229413		1 off	Note on engineering: Connect a standard auxiliary contact (HIN) as N/O in series with the coil of the shunt release! Standard auxiliary contact not included as standard.

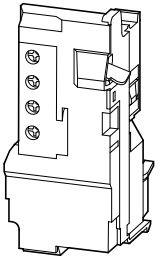
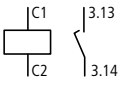
	Part no. Article no.	Price See price list	Std. pack	Notes
With screw terminal				
Shunt releases				
For mesh network circuit-breakers For intermittent operation Maximum On-time = 1 s Operating range 10-110 % U_s Not UL/CSA approved				Rated control voltage 230 V AC For use with NZM3(-4), N3(-4) and NZM4(-4), N4(-4) Cannot be installed simultaneously with early-make auxiliary contact NZM...-XHIV... or undervoltage release NZM...-XU... Intermittent operation guaranteed by series connection of a make contact M22-(C)K10. The maximum duty factor of the shunt releases for mesh network circuit-breakers is 1 s.
 Without auxiliary contacts	NZM3-XA-230AC-MNS 274097		1 off	
 With early-make auxiliary contact	NZM3-XAHIV-230AC-MNS 274141		1 off	
 Without auxiliary contacts	NZM4-XA-230AC-MNS 274138			
 With early-make auxiliary contact	NZM4-XAHIV-230AC-MNS 274143		1 off	
				
<p>① Reverse power relay contact from mesh network relay</p> <p>-S11 Remote off</p> <p>q Standard auxiliary contacts</p> <p>-Q1 Shunt releases</p>				
<p>NZM...-XAHIV: Cannot be used in conjunction with remote operator NZM...-XR...</p> <p>NZM3: Early make of auxiliary contact on switching on and off (manual operation): approx. 20 ms. NZM4: Early make of auxiliary contact on switching on (manual operation): approx. 90 ms.</p>				

For use with	Rated control voltage U_s V	Part no. Article no. when ordered separately	Price See price list	Std. pack	Notes	
Shunt releases						
With early-make auxiliary contact						
Not in combination with remote operator.						
 	With clamp terminal on left switch side.	NZM1(-4), N(S)1(-4)	12 V AC/DC	NZM1-XAHIV12AC/DC 259772	1 off  	When the shunt release is live, contact with the switch's main contacts on switching on is reliably prevented. Early make of auxiliary contact on switching on and off (manual operation): approx. 20 ms. Undervoltage release cannot be installed simultaneously with early-make auxiliary contact NZM...-XHIV... or undervoltage release NZM...-XU...
			24 V AC/DC	NZM1-XAHIV24AC/DC 259774		
			48 V AC/DC	NZM1-XAHIV48AC/DC 259776		
			60 V AC/DC	NZM1-XAHIV60AC/DC 259778		
			110 V-130 V AC/DC	NZM1-XAHIV110-130AC/DC 259780		
			208 V-250 V AC/DC	NZM1-XAHIV208-250AC/DC 259782		
			380 V-440 V AC/DC	NZM1-XAHIV380-440AC/DC 259784		
 	With 3 m connection cable instead of screw connection	NZM1(-4), N(S)1(-4)	12 V AC/DC	NZM1-XAHIVL12AC/DC 259790	1 off  	
			24 V AC/DC	NZM1-XAHIVL24AC/DC 259792		
			110 V-130 V AC/DC	NZM1-XAHIVL110-130AC/DC 259798		
			208 V-250 V AC/DC	NZM1-XAHIVL208-250AC/DC 259800		
			380 V-440 V AC/DC	NZM1-XAHIVL380-440AC/DC 259802		
 	With clamp terminal on left switch side.	NZM2(-4), N(S)2(-4) NZM3(-4), N(S)3(-4)	12 V AC/DC	NZM2/3-XAHIV12AC/DC 259808	1 off  	
			24 V AC/DC	NZM2/3-XAHIV24AC/DC 259810		
			48 V AC/DC	NZM2/3-XAHIV48AC/DC 259812		
			60 V AC/DC	NZM2/3-XAHIV60AC/DC 259814		
			110 V-130 V AC/DC	NZM2/3-XAHIV110-130AC/DC 259816		
			208 V-250 V AC/DC	NZM2/3-XAHIV208-250AC/DC 259818		
			380 V-440 V AC/DC	NZM2/3-XAHIV380-440AC/DC 259820		
 	With clamp terminal on left switch side.	NZM4(-4), N(S)4(-4)	12 V AC/DC	NZM4-XAHIV12AC/DC 266470	1 off  	
			24 V AC/DC	NZM4-XAHIV24AC/DC 266471		
			48 V AC/DC	NZM4-XAHIV48AC/DC 266472		
			60 V AC/DC	NZM4-XAHIV60AC/DC 266473		
			110 V-130 V AC/DC	NZM4-XAHIV110-130AC/DC 266474		
			208 V-250 V AC/DC	NZM4-XAHIV208-250AC/DC 266475		
			380 V-440 V AC/DC	NZM4-XAHIV380-440AC/DC 266476		

Information relevant for export to North America



Product Standards
UL File No.
UL CCN
CSA File No.
CSA Class No.
NA Certification

UL489; CSA-C22.2 No. 5-09; IEC60947, CE marking
E140305
DIHS
Q22086
1437-01
UL Listed, CSA certified







Product view		For use with	Standard	Part no. Article no. when ordered separately	Price See price list	Std. pack	Notes
Door coupling rotary handles							
Complete including rotary drive and coupling parts An additional extension shaft is necessary with the NZM...-XT(V)D(V)(R)(-60) part numbers. Degree of protection IP66/UL/CSA type 4X, 12							
Standard, black/grey							
		Lockable in 0 position on handle with up to 3 padlocks. With door interlock.	NZM1(-4), PN1(-4), N(S)1(-4)	NZM1-XTVD 260166		1 off 	Door interlock • Not defeated in the locked OFF and ON positions • Can be modified such that it can be defeated from the outside using a screwdriver, when it is in the unlocked ON position. • Door can be opened in OFF NZM...-XTVD(V) • External warning plate/designation label can be clipped on
			NZM2(-4), PN2(-4), N(S)2(-4)	NZM2-XTVD 260168			
			NZM3(-4), PN3(-4), N(S)3(-4)	NZM3-XTVD 260170			
			NZM4(-4), N(S)4(-4)	NZM4-XTVD 266614			
		Lockable on handle and switch with up to 3 padlocks. Can be locked in 0 position, with adequate modification also in I position. With door interlock. Lockable on switch in 0 position.	NZM1(-4), PN1(-4), N(S)1(-4)	NZM1-XTVDV 260172			
			NZM2(-4), PN2(-4), N(S)2(-4)	NZM2-XTVDV 260174			
			NZM3(-4), PN3(-4), N(S)3(-4)	NZM3-XTVDV 260176			
			NZM4(-4), N(S)4(-4)	NZM4-XTVDV 266616			
Red-yellow for emergency switching off							
		Lockable on handle and switch with up to 3 padlocks. Lockable in 0 position on handle. With door interlock. Lockable on switch in 0 position.	NZM1(-4), PN1(-4), N(S)1(-4)	NZM1-XTVDVR 260178		1 off 	Door interlock • Not defeated in the locked OFF position. • Can be modified such that it can be defeated from the outside using a screwdriver, when it is in the unlocked ON position. • Door can be opened in OFF NZM...-XTVDVR • External warning plate/designation label can be clipped on
			NZM2(-4), PN2(-4), N(S)2(-4)	NZM2-XTVDVR 260180			
			NZM3(-4), PN3(-4), N(S)3(-4)	NZM3-XTVDVR 260182			
			NZM4(-4), N(S)4(-4)	NZM4-XTVDVR 266618			
Extension shaft							
		400 mm max. mounting depth	NZM1(-4), PN1(-4), N(S)1(-4) NZM2(-4), PN2(-4), N(S)2(-4) NZM3(-4), PN3(-4), N(S)3(-4) NZM4(-4), N(S)4(-4)	NZM1/2-XV4 261232		1 off 	Length 290 mm, can be cut to required length.
		600 mm max. mounting depth	NZM1(-4), PN1(-4), N(S)1(-4) NZM2(-4), PN2(-4), N(S)2(-4) NZM3(-4), PN3(-4), N(S)3(-4) NZM4(-4), N(S)4(-4)	NZM1/2-XV6 260191 NZM3/4-XV6 260193			







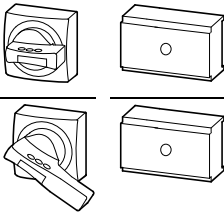

Notes

Circuit-breaker can also be installed in a horizontal position 90° left/right, with the handle still in the same position.

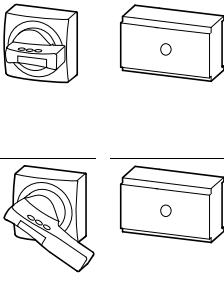

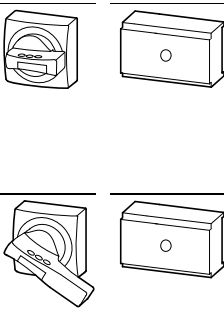

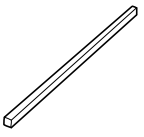
HPL17119EN

For maximum shaft length 60 mm		Std. pack	Notes	Extremely narrow fittings		Std. pack	Notes	Information relevant for export to North America 
Part no. Article no. when ordered separately	Price See price list			Part no. Article no. when ordered separately	Price See price list			
NZM1-XTVD-60 271504		1 off 	Door interlock <ul style="list-style-type: none"> Can not be defeated in the locked OFF and ON positions Can be modified such that it can be defeated from the outside using a screwdriver, when it is in the unlocked ON position. Door can be opened in OFF NZM...-XTVD(V)-60 <ul style="list-style-type: none"> For maximum shaft length 60 mm Without shaft support Cannot be combined with additional handle NZM...-XDZ External warning plate/designation label can be clipped on. 	NZM1-XTVD-0 279392		1 off 	Door interlock <ul style="list-style-type: none"> Can not be defeated in the locked OFF and ON positions Can be modified such that it can be defeated from the outside using a screwdriver, when it is in the unlocked ON position. Door can be opened in OFF NZM...-XTVD(V)-0 <ul style="list-style-type: none"> For extremely narrow fittings With special short extension shaft Cannot be combined with additional handle NZM...-XDZ External warning plate/designation label can be clipped on. 	Product Standards UL489; CSA-C22.2 No. 5-09; IEC60947, CE marking UL File No. E140305 UL CCN DIHS CSA File No. 022086 CSA Class No. 1437-01 NA Certification UL Listed, CSA certified Degree of Protection IEC: IP66, UL/CSA Type 4X, 12
NZM2-XTVD-60 271505				NZM2-XTVD-0 279393				
NZM3-XTVD-60 271506				NZM3-XTVD-0 279394				
NZM4-XTVD-60 271507				NZM4-XTVD-0 279395				
NZM1-XTVDV-60 271508				NZM1-XTVDV-0 279396				
NZM2-XTVDV-60 271509				NZM2-XTVDV-0 279397				
NZM3-XTVDV-60 271510				NZM3-XTVDV-0 279398				
NZM4-XTVDV-60 271511		NZM4-XTVDV-0 279399						
NZM1-XTVDVR-60 271512		1 off 	Door interlock <ul style="list-style-type: none"> Can not be defeated in the locked OFF position. Can be modified such that it can be defeated from the outside using a screwdriver, when it is in the unlocked ON position. Door can be opened in OFF NZM...-XTVDVR-60 <ul style="list-style-type: none"> For maximum shaft length 60 mm Without shaft support Cannot be combined with additional handle NZM...-XDZ External warning plate/designation label can be clipped on. 	NZM1-XTVDVR-0 279400		1 off 	Door interlock <ul style="list-style-type: none"> Can not be defeated in the locked OFF position. Can be modified such that it can be defeated from the outside using a screwdriver, when it is in the unlocked ON position. Door can be opened in OFF NZM...-XTVDVR-0 <ul style="list-style-type: none"> For extremely narrow fittings With special short extension shaft Cannot be combined with additional handle NZM...-XDZ External warning plate/designation label can be clipped on. 	UL/CSA certification not required
NZM2-XTVDVR-60 271513				NZM2-XTVDVR-0 279401				
NZM3-XTVDVR-60 271514				NZM3-XTVDVR-0 279402				
NZM4-XTVDVR-60 271515				NZM4-XTVDVR-0 279403				
-								
-								
-								
-								















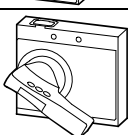



Product view	For use with	Standard	Part no. Article no. when ordered separately	Price See price list	Std. pack	Notes
Door coupling rotary handles						
Complete including rotary drive and coupling parts Extension shaft additionally required. Degree of protection IP66/UL/CSA type 4X, 12 Difference to normal IEC handles: Door opening only possible with active rotation beyond the 0 position.						
Standard, black/grey						
	Lockable in 0 position on handle. With door interlock.	NZM1, N1	NZM1-XTVD-NA 271445		1 off 	Door interlock <ul style="list-style-type: none"> • Can not be defeated in the locked OFF position. • Door opening with active rotation beyond the 0 position. • Cannot be combined with mechanical interlock • External warning plate/designation label can be clipped on.
		NZM2, N2	NZM2-XTVD-NA 271446			
		NZM3, N3	NZM3-XTVD-NA 271447			
		NZM4, N4	NZM4-XTVD-NA 271448			
	Lockable on handle and switch with up to 3 padlocks. Lockable in 0 position on handle. With door interlock. Lockable on switch in 0 position.	NZM1, N(S)1	NZM1-XTVDV-NA 100683		1 off 	Door interlock <ul style="list-style-type: none"> • Can not be defeated in the locked OFF position. • Door opening possible with active rotation beyond the 0 position. Can be defeated from the outside using a screwdriver. • Cannot be combined with mechanical interlock • External warning plate/designation label can be clipped on.
		NZM2, N(S)2	NZM2-XTVDV-NA 100684			
		NZM3, N(S)3	NZM3-XTVDV-NA 100685			
		NZM4, N(S)4	NZM4-XTVDV-NA 100686			
Red-yellow for emergency switching off						
	Lockable on handle and switch with up to 3 padlocks. Lockable in 0 position on handle. With door interlock. Lockable on switch in 0 position.	NZM1, N(S)1	NZM1-XTVDV-NA 271449		1 off 	Door interlock <ul style="list-style-type: none"> • Can not be defeated in the locked OFF position. • Door opening with active rotation beyond the 0 position. • Cannot be combined with mechanical interlock • External warning plate/designation label can be clipped on.
		NZM2, N(S)2	NZM2-XTVDV-NA 271450			
		NZM3, N(S)3	NZM3-XTVDV-NA 271451			
		NZM4, N(S)4	NZM4-XTVDV-NA 271452			
Extension shaft						
	400 mm max. mounting depth	NZM1(-4), PN1(-4), N(S)1(-4) NZM2(-4), PN2(-4), N(S)2(-4) NZM3(-4), PN3(-4), N(S)3(-4) NZM4(-4), N(S)4(-4)	NZM1/2-XV4 261232		1 off 	Length 290 mm, can be cut to required length.
	600 mm max. mounting depth	NZM1(-4), PN1(-4), N(S)1(-4) NZM2(-4), PN2(-4), N(S)2(-4) NZM3(-4), PN3(-4), N(S)3(-4) NZM4(-4), N(S)4(-4)	NZM1/2-XV6 260191			
Notes Circuit-breaker can also be installed in a lying position 90° left/right, with the handle still in the same position.						

HPL17121EN

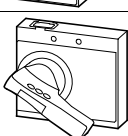
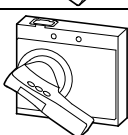











For maximum shaft length 60 mm				Extremely narrow fittings				Information relevant for export to North America 
Part no. Article no.	Price See price list	Std. pack	Notes	Part no. Article no.	Price See price list	Std. pack	Notes	
NZM1-XTVDV-60-NA 100667		1 off 	<p>Door interlock</p> <ul style="list-style-type: none"> Can not be defeated in the locked OFF position. Door opening possible with active rotation beyond the 0 position. Can be defeated from the outside using a screwdriver. Cannot be combined with mechanical interlock External warning plate/ designation label can be clipped on. <p>NZM...-XTVDV-60-NA</p> <ul style="list-style-type: none"> For a maximum shaft length of 60 mm Without shaft support Cannot be combined with additional handle NZM...-XDZ External warning plate/ designation label can be clipped on. 	NZM1-XTVDV-0-NA 100675		1 off 	<p>Door interlock</p> <ul style="list-style-type: none"> Can not be defeated in the locked OFF position. Door opening possible with active rotation beyond the 0 position. Can be defeated from the outside using a screwdriver. Cannot be combined with mechanical interlock External warning plate/ designation label can be clipped on. <p>NZM...-XTVDV-0-NA</p> <ul style="list-style-type: none"> For extremely narrow fittings With special short extension shaft Cannot be combined with additional handle NZM...-XDZ External warning plate/ designation label can be clipped on. 	<p>Product Standards</p> <p>UL489; CSA-C22.2 No. 5-09; IEC60947, CE marking</p> <p>UL File No. E140305 UL CCN DIHS CSA File No. 022086 CSA Class No.1437-01</p> <p>NA Certification</p> <p>UL Listed, CSA certified</p> <p>Degree of Protection</p> <p>IEC: IP66, UL/CSA Type 4X, 12</p>
NZM2-XTVDV-60-NA 100668				NZM2-XTVDV-0-NA 100676				
NZM3-XTVDV-60-NA 100669				NZM3-XTVDV-0-NA 100677				
NZM4-XTVDV-60-NA 100670				NZM4-XTVDV-0-NA 100678				
NZM1-XTVDVR-60-NA 100671		1 off 	<p>Door interlock</p> <ul style="list-style-type: none"> Can not be defeated in the locked OFF position. Door opening with active rotation beyond the 0 position. Cannot be combined with mechanical interlock External warning plate/ designation label can be clipped on. <p>NZM...-XTVDVR-60-NA</p> <ul style="list-style-type: none"> For a maximum shaft length of 60 mm Without shaft support Cannot be combined with additional handle NZM...-XDZ External warning plate/ designation label can be clipped on. 	NZM1-XTVDVR-0-NA 100679		1 off 	<p>Door interlock</p> <ul style="list-style-type: none"> Can not be defeated in the locked OFF position. Door opening with active rotation beyond the 0 position. Cannot be combined with mechanical interlock External warning plate/ designation label can be clipped on. <p>NZM...-XTVDVR-0-NA</p> <ul style="list-style-type: none"> For extremely narrow fittings With special short extension shaft Cannot be combined with additional handle NZM...-XDZ External warning plate/ designation label can be clipped on. 	<p>Product Standards</p> <p>UL489; CSA-C22.2 No. 5-09; IEC60947, CE marking</p> <p>UL File No. E140305 UL CCN DIHS CSA File No. 022086 CSA Class No.1437-01</p> <p>NA Certification</p> <p>UL Listed, CSA certified</p> <p>Degree of Protection</p> <p>IEC: IP66, UL/CSA Type 4X, 12</p>
NZM2-XTVDVR-60-NA 100672				NZM2-XTVDVR-0-NA 100680				
NZM3-XTVDVR-60-NA 100673				NZM3-XTVDVR-0-NA 100681				
NZM4-XTVDVR-60-NA 100674				NZM4-XTVDVR-0-NA 100682				
								UL/CSA certification not required



For use with		Part no. Article no. for separate order	Price See price list	Std. pack	Notes	Information relevant for export to North America 
Rotary handle on circuit-breaker						
Complete with rotary drive						
Standard, black/grey						
	Lockable in 0 position on switch with up to 3 padlocks.	NZM1(-4), PN1(-4), N(S)1(-4)	NZM1-XDV 260125	1 off 	NZM1, 2, 3: Can also be combined with insulating surround. MODAN handle position detection by wire release can be retrofitted.	Product Standards UL489; CSA-C22.2 No. 5-09; IEC60947, CE marking E140305 UL File No. UL CCN CSA File No. CSA Class No. NA Certification DIHS 022086 1437-01 UL Listed, CSA certified
		NZM2(-4), PN2(-4), N(S)2(-4)	NZM2-XDV 260127			
		NZM3(-4), PN3(-4), N(S)3(-4)	NZM3-XDV 260129			
		NZM4(-4), N(S)4(-4)	NZM4-XDV 266608			
	Lockable in 0 position on handle with up to 3 padlocks.	NZM1(-4), PN1(-4), N(S)1(-4)	NZM1-XDVG 285247	1 off 	Can also be combined with insulating surround.	
		NZM2(-4), PN2(-4), N(S)2(-4)	NZM2-XDVG 285248			
Red-yellow for emergency switching off						
	Lockable in 0 position on switch with up to 3 padlocks.	NZM1(-4), PN1(-4), N(S)1(-4)	NZM1-XDVR 260135	1 off 	NZM1, 2, 3: Can also be combined with insulating surround. MODAN handle position detection by wire release can be retrofitted.	Product Standards UL489; CSA-C22.2 No. 5-09; IEC60947, CE marking E140305 UL File No. UL CCN CSA File No. CSA Class No. NA Certification DIHS 022086 1437-01 UL Listed, CSA certified
		NZM2(-4), PN2(-4), N(S)2(-4)	NZM2-XDVR 260137			
		NZM3(-4), PN3(-4), N(S)3(-4)	NZM3-XDVR 260140			
		NZM4(-4), N(S)4(-4)	NZM4-XDVR 266610			
	Lockable in 0 position on handle with up to 3 padlocks.	NZM1(-4), PN1(-4), N(S)1(-4)	NZM1-XDVGR 285249	1 off 	Can also be combined with insulating surround.	
		NZM2(-4), PN2(-4), N(S)2(-4)	NZM2-XDVGR 285280			







Notes



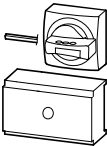

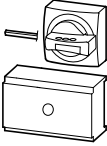
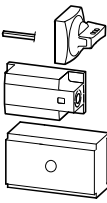
Circuit-breaker can also be installed in a lying position 90° left/right, with the handle still in the same position.

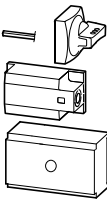
	For use with	Part no. Article no. when ordered separately	Price See price list	Std. pack	Notes	Information relevant for export to North America 		
Rotary handles on switch with door interlock								
Complete with rotary drive and insulating surround								
Standard, black/grey								
	Lockable in 0 position on handle with up to 3 padlocks, can also be modified for the I position. Also available with door interlock e.g. for MCC service distribution.	NZM1(-4), PN1(-4), N(S)1(-4)	NZM1-XDTV 260131	1 off 	Door interlock <ul style="list-style-type: none"> In the ON position, can be defeated from the outside using a 1 mm pin Can not be defeated in the locked OFF and ON positions Door can be opened in OFF Can only be switched ON when the door is closed 	Product Standards UL489; CSA-C22.2 No. 5-09; IEC60947, CE marking E140305 UL File No. DIHS UL CCN 022086 CSA File No. 1437-01 CSA Class No. UL Listed, CSA certified NA Certification		
		NZM2(-4), PN2(-4), N(S)2(-4)	NZM2-XDTV 260133					
Red-yellow for emergency switching off								
	Lockable in 0 position on handle with up to 3 padlocks. Also available with door interlock e.g. for MCC service distribution.	NZM1(-4), PN1(-4), N(S)1(-4)	NZM1-XDTVR 260142	1 off 				
		NZM2(-4), PN2(-4), N(S)2(-4)	NZM2-XDTVR 260144					
Rotary handles on switch with door interlock for UL/CSA approved NA switches								
Difference to normal IEC handles: Door opening only possible with active rotation beyond the 0 position.								
Complete with rotary drive and insulating surround								
Standard, black/grey								
	Lockable in 0 position on handle with up to 3 padlocks, can also be modified for the I position. Also available with door interlock e.g. for MCC service distribution.	NZM1, N(S)1	NZM1-XDTV-NA 271453	1 off 	Door interlock <ul style="list-style-type: none"> In the ON position, can be defeated from the outside using a 1 mm pin Can not be defeated in the locked OFF and ON positions Door opening only possible with active rotation beyond the 0 position. Can only be switched ON when the door is closed Cannot be combined with mechanical interlock 	Product Standards UL489; CSA-C22.2 No. 5-09; IEC60947, CE marking E140305 UL File No. DIHS UL CCN 022086 CSA File No. 1437-01 CSA Class No. UL Listed, CSA certified NA Certification		
		NZM2, N(S)2	NZM2-XDTV-NA 271454					
Red-yellow for emergency switching off								
	Lockable in 0 position on handle with up to 3 padlocks. Also available with door interlock e.g. for MCC service distribution.	NZM1, N(S)1	NZM1-XDTVR-NA 271455	1 off 				
		NZM2, N(S)2	NZM2-XDTVR-NA 271456					

Notes Circuit-breaker can also be installed in a lying position 90° left/right, with the handle still in the same position.

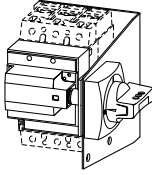

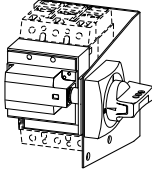



		Model	For use with	Part no. Article no. for separate order	Price See price list	Std. pack	Information relevant for export to North America 
Main switch assembly kit							
Equipment supplied: <ul style="list-style-type: none"> • Door coupling rotary handle • Extension shaft NZM...-XV4 • External warning plate/designation label in German/English • Black and yellow flash For enhanced protection against direct contact on the in-circuit side, IP2X protection against contact with a finger can be ordered → Page 17/84 Other external warning plates/designation labels can be clipped on. Degree of protection IP66/UL/CSA type 4X, 12							
With black door coupling rotary handle							
	Lockable in 0 position on handle with up to 3 padlocks, can also be modified for the I position. With door interlock.	–	NZM1(-4) PN1(-4), N(S)1(-4)	NZM1-XHB 266626		1 off 	Product Standards UL489; CSA-C22.2 No. 5-09; IEC60947, CE marking E140305 UL File No. DIHS UL CCN 022086 CSA File No. 1437-01 CSA Class No. UL Listed, CSA certified NA Certification IEC: IP66, UL/CSA Type 4X, 12
		–	NZM2(-4) PN2(-4), N(S)2(-4)	NZM2-XHB 266627			
		–	NZM3(-4) PN3(-4), N(S)3(-4)	NZM3-XHB 266628			
		–	NZM4(-4) N(S)4(-4)	NZM4-XHB 271779			
With red door coupling rotary handle for use of switch as emergency switching off device to IEC/EN 60204-1							
	Lockable in 0 position on handle with up to 3 padlocks. Lockable door as additional feature, locking facility on circuit-breaker in 0 position.	–	NZM1(-4) PN1(-4), N(S)1(-4)	NZM1-XHBR 266632			
		–	NZM2(-4) PN2(-4), N(S)2(-4)	NZM2-XHBR 266633			
		–	NZM3(-4) PN3(-4), N(S)3(-4)	NZM3-XHBR 266634			
		–	NZM4(-4) N(S)4(-4)	NZM4-XHBR 271842			
For side wall installation							
Actuation of the switch on the control panel side wall Switch mounting on mounting plate Standard, black/grey							
	Lockable in 0 position on handle with up to 3 padlocks, with adequate modification also in I position.	For operation on the left	NZM1(-4) PN1(-4), N(S)1(-4)	NZM1-XS-L 266641	1 off 	Product Standards UL489; CSA-C22.2 No. 5-09; IEC60947, CE marking E140305 UL File No. DIHS UL CCN 022086 CSA File No. 1437-01 CSA Class No. UL Listed, CSA certified NA Certification IEC: IP66, UL/CSA Type 4X, 12	
			NZM2(-4) PN2(-4), N(S)2(-4)	NZM2-XS-L 266642			
			NZM3(-4) PN3(-4), N(S)3(-4)	NZM3-XS-L 266643			
			NZM4(-4) N(S)4(-4)	NZM4-XS-L 289806			
		For operation on the right	NZM1(-4) PN1(-4), N(S)1(-4)	NZM1-XS-R 266644			
			NZM2(-4) PN2(-4), N(S)2(-4)	NZM2-XS-R 266645			
			NZM3(-4) PN3(-4), N(S)3(-4)	NZM3-XS-R 266646			
			NZM4(-4) N(S)4(-4)	NZM4-XS-R 289807			
Red-yellow for emergency switching off							
	Lockable in 0 position on handle with up to 3 padlocks.	For operation on the left	NZM1(-4) PN1(-4), N(S)1(-4)	NZM1-XSR-L 266653	1 off 	Product Standards UL489; CSA-C22.2 No. 5-09; IEC60947, CE marking E140305 UL File No. DIHS UL CCN 022086 CSA File No. 1437-01 CSA Class No. UL Listed, CSA certified NA Certification IEC: IP66, UL/CSA Type 4X, 12	
			NZM2(-4) PN2(-4), N(S)2(-4)	NZM2-XSR-L 266654			
			NZM3(-4) PN3(-4), N(S)3(-4)	NZM3-XSR-L 266655			
			NZM4(-4) N(S)4(-4)	NZM4-XSR-L 289808			
		For operation on the right	NZM1(-4) PN1(-4), N(S)1(-4)	NZM1-XSR-R 266656			
			NZM2(-4) PN2(-4), N(S)2(-4)	NZM2-XSR-R 266657			
			NZM3(-4) PN3(-4), N(S)3(-4)	NZM3-XSR-R 266658			
			NZM4(-4) N(S)4(-4)	NZM4-XSR-R 289809			



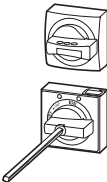



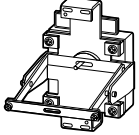

	Model	For use with	Part no. Article no. when ordered separately	Price See price list	Std. pack	Information relevant for export to North America 
Main switch assembly kit for side wall installation with mounting bracket. For direct mounting of circuit-breaker and handle in the side wall of the control cabinet Equipment supplied: • Door coupling rotary handle • Mounting bracket • Special short extension shaft • External warning plate/designation label in German/English • Black and yellow flash For enhanced protection against direct contact on the incomer side, IP2X protection against contact with a finger can be ordered → Page 17/84 Other external warning plates/designation labels can be clipped on. Degree of protection IP66/UL/CSA type 4X, 12						
Standard, black/grey						
	Lockable in 0 position, with adequate modification also in I position. Minimum clearance between control panel side walls and circuit-breaker is defined by mounting bracket. Extension cannot be used.	For operation on the left	NZM1(-4) PN1(-4), N(S)1(-4)	NZM1-XSM-L 266663	1 off 	Product Standards UL489; CSA-C22.2 No. 5-09; IEC60947, CE marking E140305 UL File No. UL CCN CSA File No. 022086 CSA Class No. 1437-01 NA Certification UL Listed, CSA certified Degree of Protection IEC: IP66, UL/CSA Type 4X, 12
		For operation on the left	NZM2(-4) PN2(-4), N(S)2(-4)	NZM2-XSM-L 266664		
		For operation on the right	NZM1(-4) PN1(-4), N(S)1(-4)	NZM1-XSM-R 266665		
		For operation on the right	NZM2(-4) PN2(-4), N(S)2(-4)	NZM2-XSM-R 266666		
Red-yellow for emergency switching off						
	Lockable in 0 position on handle. Minimum clearance between control panel side walls and circuit-breaker is defined by mounting bracket. Extension cannot be used.	For operation on the left	NZM1(-4) PN1(-4), N(S)1(-4)	NZM1-XSRM-L 266671	1 off 	Product Standards UL489; CSA-C22.2 No. 5-09; IEC60947, CE marking E140305 UL File No. UL CCN CSA File No. 022086 CSA Class No. 1437-01 NA Certification UL Listed, CSA certified Degree of Protection IEC: IP66, UL/CSA Type 4X, 12
		For operation on the left	NZM2(-4) PN2(-4), N(S)2(-4)	NZM2-XSRM-L 266672		
		For operation on the right	NZM1(-4) PN1(-4), N(S)1(-4)	NZM1-XSRM-R 266673		
		For operation on the right	NZM2(-4) PN2(-4), N(S)2(-4)	NZM2-XSRM-R 266674		
Additional plate						
For fitting to the mounting bracket when using neutral conductor or PE conductor terminals K25, K50, K95 or K150.						
			NZM1(-4), PN1(-4), N(S)1(-4) NZM2(-4), N(S)2(-4)	NZM1/2-XZB 266676	1 off 	UL/CSA certification not required

Notes Additional terminal arrangement for side wall operator with mounting bracket.
 → Engineering, Page 17/153

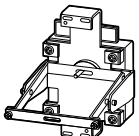

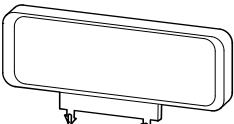
Model	For use with	Part no. Article no. when ordered separately	Price See price list	Std. pack	Information relevant for export to North America 			
Main switch assembly kit with additional rotary handle								
Main switch assembly kit with additional rotary handle for switching with opened control panel door								
Equipment supplied:								
<ul style="list-style-type: none"> • Door coupling rotary handle • Additional rotary handle on switch with "Deliberate Action" operation • Extension shaft NZM...-XV6 for mounting depth 600 mm, NZM1/2-XV4 with NZM1 for mounting depth 400 mm • External warning plate/designation label in German/English • Black and yellow flash 								
For enhanced protection against direct contact on the incomer side, IP2X protection against contact with a finger can be ordered → Page 17/84								
Other external warning plates/designation labels can be clipped on.								
Degree of protection IP66/UL/CSA type 4X, 12								
With black door coupling rotary handle								
	Lockable in 0 position on handle with up to 3 padlocks, can also be modified for the I position. Lockable door as additional feature, locking facility on circuit-breaker in 0 position.	IEC	NZM1(-4) PN1(-4), N1(-4)	NZM1-XHB-DA 125956	1 off 	Product Standards UL489; CSA-C22.2 No. 5-09; IEC60947, CE marking E140305 DIHS UL File No. UL CCN CSA File No. CSA Class No. NA Certification UL Listed, CSA certified Degree of Protection IEC: IP66, UL/CSA Type 4X, 12		
	UL/CSA	NZM1(-4) PN1(-4), N(S)1(-4)	NZM1-XHB-DA-NA 125958					
	IEC	NZM2(-4) PN2(-4), N(S)2(-4)	NZM2-XHB-DA 116895					
	UL/CSA	NZM2(-4) PN2(-4), N(S)2(-4)	NZM2-XHB-DA-NA 116897					
	IEC	NZM3(-4) PN3(-4), N(S)3(-4)	NZM3-XHB-DA 118988					
	UL/CSA	NZM3(-4) PN3(-4), N(S)3(-4)	NZM3-XHB-DA-NA 119000					
	IEC	NZM4(-4) PN4(-4), N(S)4(-4)	NZM4-XHB-DA 119002					
	UL/CSA	NZM4(-4) PN4(-4), N(S)4(-4)	NZM4-XHB-DA-NA 119004					
	With red door coupling rotary handle							
	For use of switch as emergency switching off device							
	Lockable in 0 position on handle with up to 3 padlocks. With door interlock and lockable on switch in 0 position.	IEC	NZM1(-4) PN1(-4), N1(-4)	NZM1-XHB-DAR 125957	1 off 	Product Standards UL489; CSA-C22.2 No. 5-09; IEC60947, CE marking E140305 DIHS UL File No. UL CCN CSA File No. CSA Class No. NA Certification UL Listed, CSA certified Degree of Protection IEC: IP66, UL/CSA Type 4X, 12		
	UL/CSA	NZM1(-4) PN1(-4), N(S)1(-4)	NZM1-XHB-DAR-NA 125959					
	IEC	NZM2(-4) PN2(-4), N(S)2(-4)	NZM2-XHB-DAR 116896					
	UL/CSA	NZM2(-4) PN2(-4), N(S)2(-4)	NZM2-XHB-DAR-NA 116898					
	IEC	NZM3(-4) PN3(-4), N(S)3(-4)	NZM3-XHB-DAR 118989					
	UL/CSA	NZM3(-4) PN3(-4), N(S)3(-4)	NZM3-XHB-DAR-NA 119001					
	IEC	NZM4(-4) PN4(-4), N(S)4(-4)	NZM4-XHB-DAR 119003					
	UL/CSA	NZM4(-4) PN4(-4), N(S)4(-4)	NZM4-XHB-DAR-NA 119005					



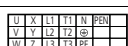





		For use with	Part no. Article no.	Price See price list	Std. pack	Notes
Rear-mounted drives						
For direct rear connection of the switch to the side of the control panel or control panel door. Switch actuation on rear through side wall or control panel door. For switch with toggle lever. For enhanced protection against direct contact on the incomer side, IP2X protection against contact with a finger can be ordered → Page 17/84 Degree of protection IP66, UL/CSA type 4X, 12						
Standard, black/grey						
	Lockable in 0 position on handle with up to 3 padlocks.	NZM1, N1, NS1, PN1	NZM1-XRAV 107245		1 off  	External warning plate can be clipped on
		NZM2, N2, NS2, PN2	NZM2-XRAV 107247			
Red-yellow for emergency switching off						
	Lockable in 0 position on handle with up to 3 padlocks.	NZM1, N1, NS1, PN1	NZM1-XRAVR 107249		1 off  	
		NZM2, N2, NS2, PN2	NZM2-XRAVR 107261			
External warning plate/designation label						
						
"Main switch – open in 0 position"	German/English	NZM1(-4), PN1(-4), N(S)1(-4) NZM2(-4), PN2(-4), N(S)2(-4) NZM3(-4), PN3(-4), N(S)3(-4) NZM4(-4), N(S)4(-4)	ZFS61/62-NZM7 272525		10 off	A bilingual external warning plate/designation label in German/English is already included in the main switch assembly kit.
			ZFS61-NZM7 051089			
			ZFS62-NZM7 065957			
			ZFS63-NZM7 065958			
			ZFS82-NZM 104910			
			ZFS83-NZM 105945			
Symbol	Circuit-breaker symbol		ZFS*-NZM7 999978		1 off	External warning plates are available in the following languages: 64 Bulgarian 74 Russian 65 Danish 75 Swedish 66 Finnish 76 Serbo-Croatian 67 Dutch 77 Spanish 68 Italian 78 Czech 69 Greek 79 Turkish 70 Norwegian 80 Hungarian 71 Polish 81 Afrikaans 72 Portuguese 82 Chinese/English 73 Romanian 83 Chinese
			ZFS-LS-NZM 104829			
			ZFS-LTS-NZM 104828			
Blank	Blank (for engraving or printing)		ZFS-TS-NZM 115365		10 off	To obtain the order number, insert the language code number into the part number required. Ordering example External warning plate in Finnish: ZFS66-NZM7
			ZFS60-NZM7 065896			
Lightning symbol						
Including terminal marking for main switch						
	Small		NZM1(-4), PN1(-4), N(S)1(-4) NZM2(-4), PN2(-4), N(S)2(-4)	BPF-NZM7 217294	10 off	Included as standard in main switch assembly kit Marking of the input side of the switch is possible
		Large				

Information relevant for export to North America



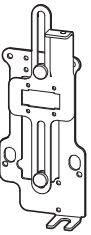

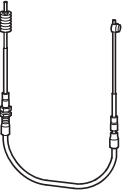









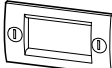

Product Standards UL489; CSA-C22.2 No. 5-09; IEC60947, CE marking
UL File No. E140305
UL CCN DIHS
CSA File No. 022086
CSA Class No. 1437-01
NA Certification UL Listed, CSA certified
Degree of Protection IEC: IP66, UL/CSA Type 4X, 12

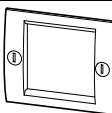
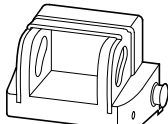

For use with		Part no. Article no.	Price See price list	Std. pack	Notes	Information relevant for export to North America 
Side-mounted handle						
<p>For mounting outside the control panel door. Actuation of a switch with toggle lever using a Bowden cable and mechanical components mounted on the front of the switch. For switch with toggle lever.</p> <p>Caution! Intended exclusively for use outside the scope of validity of the IEC/EN 60947 area.</p>						
Handle, metal, black/red						
	Degree of protection UL/CSA Type 12	NZM2...-NA, NS2...-NA NZM3...-NA, NS3...-NA	NZM-XSHGVR12-NA 107269	1 off 	Lockable in 0-position on handle with up to 3 padlocks, for 1 door of an American style control panel (door plus wide bar beside the door). For each handle 1 additional mechanical unit and 1 Bowden cable is required.	Product Standards UL489; CSA-C22.2 No. 5-09 UL File No. E140305 UL CCN DIHS CSA File No. 236770 CSA Class No. 1437-01 NA Certification UL Listed, CSA certified Degree of Protection IEC: IP66, UL/CSA Type 12
	Degree of protection UL/CSA Type 4X		NZM-XSHGVR4X-NA 107268			Product Standards UL489; CSA-C22.2 No. 5-09 UL File No. E140305 UL CCN DIHS CSA File No. 236770 CSA Class No. 1437-01 NA Certification UL Listed, CSA certified Degree of Protection IEC: IP66, UL/CSA Type 4X
Mechanical unit						
		NZM2...-NA, NS2...-NA	NZM2-XSHM-NA 107266	1 off 	For mounting on the front of a switch with toggle lever, including fixing sundries.	UL/CSA certification not required
		NZM3...-NA, NS3...-NA	NZM3-XSHM-NA 107267			
Bowden cables						
	Nominal length 36" = 91.4 cm	NZM2...-NA, NS2...-NA	NZM-XSHBZ36-NA 107263	1 off 	-	Product Standards UL489; CSA-C22.2 No. 5-09 UL File No. E140305 UL CCN DIHS CSA File No. 236770 CSA Class No. 1437-01 NA Certification UL Listed, CSA certified
	Nominal length 48" = 121.9 cm	NZM3...-NA, NS3...-NA	NZM-XSHBZ48-NA 107264			Product Standards UL489; CSA-C22.2 No. 5-09 UL File No. E140306 UL CCN DIHS CSA File No. 236771 CSA Class No. 1437-02 NA Certification UL Listed, CSA certified
	Nominal length 60" = 152.4 cm		NZM-XSHBZ60-NA 107265			

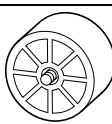
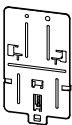
HPL17129EN

NZM...-XDZ, NZM...-XBR, NZM...-X...

For use with	Part no. Article no. when ordered separately	Price See price list	Std. pack	Notes
Additional handle				
Enables switching when control panel door is open				
 NZM1(-4), PN1(-4), N(S)1(-4) NZM2(-4), PN2(-4), N(S)2(-4)	NZM1/2-XDZ 266621		1 off  	Push-fits on to the extension shaft. 100 mm free extension shaft required. Cannot be combined with door coupling rotary handles NZM...-XT...-60 or NZM...-XT...0.
 NZM3(-4), PN3(-4), N(S)3(-4) NZM4(-4), N(S)4(-4)	NZM3/4-XDZ 266622			
Insulating surround				
For toggle levers, rotary handles with rotary drive and remote operators Degree of protection IP40				
 NZM1(-4) PN1(-4), N(S)1(-4)	NZM1-XBR 260195		1 off  	For rectangular cut-out on doors and enclosures with material thicknesses of 1.5 – 5 mm. External warning plate/designation label can be clipped on. NZM4-XBR can not be combined with rotary handle with rotary mechanism.
 NZM2(-4) PN2(-4), N(S)2(-4)	NZM2-XBR 260197			
NZM3(-4) PN3(-4), N(S)3(-4)	NZM3-XBR 284645			
NZM4(-4) N(S)4(-4)	NZM4-XBR 284646			
Toggle lever locking device				
Lockable in Off position with up to three padlocks (hasp thickness 4 – 8 mm)				
 NZM1(-4) PN1(-4), N(S)1(-4)	NZM1-XKAV 260199		1 off	Cannot be combined with insulating surround.
NZM2(-4), PN2(-4), N(S)2(-4) NZM3(-4), PN3(-4), N(S)3(-4)	NZM2/3-XKAV 260201			
Spacers				
Enables fast and attractively priced offsetting of varying construction sizes with/without rotary handle or remote operator to the same front depth				
 NZM1(-4), PN1(-4), N(S)1(-4) NZM2(-4), PN2(-4), N(S)2(-4)	NZM1/2-XAB 260203		1 set  	Grid depth 17.5 mm, M4 thread One set contains 4 spacers Maximum component fitting: NZM1: 4 off per fixing screw, NZM2: 2 off per fixing screw, 2 (NZM1) or 4 (NZM2) fixing screws contained per switch
 NZM3(-4) PN3(-4), N(S)3(-4) NZM4(-4) N(S)4(-4)	NZM3-XAB 260211			
Clips				
Allows switches to be clipped onto DIN rails				
 NZM1(-4) PN1(-4) N(S)1(-4)	NZM1-XC35 260213		1 off  	For 35 mm top-hat rails
 NZM2(-4) PN2(-4) N(S)2(-4)	NZM2-XC75 260215			For 75 mm top-hat rails Not in combination with remote operator.

Information relevant for export to North America



Product Standards
UL File No. E140305
UL CCN DIHS
CSA File No. 022086
CSA Class No. 1437-01
NA Certification UL Listed, CSA certified



	For use with	Part no. Article no. for separate order	Price See price list	Std. pack	Notes	Information relevant for export to North America
Mechanical interlock for (door coupling) rotary handles						
	NZM1(-4) PN1(-4), N(S)1(-4)	NZM1-XMV 281581		1 off 	Allows interlocking of 2, 3 or 4 switches, including different construction sized switches, with Bowden cables. For every switch an interlocking module NZM...-XMV and a rotary handle on switch NZM...-XDV or a door coupling rotary handle NZM...-XTVD and Bowden cables are required. Possible combinations and interlock variants, → Engineering Cannot be combined with UL/CSA door coupling rotary handles NZM...-XTV...-NA, paralleling mechanisms, side wall operators, remote operators or insulating surrounds. Selection and combinations of required Bowden cables → Engineering	Product Standards UL489; CSA-C22.2 No. 5-09; IEC60947, CE marking UL File No. E140305 UL CCN DIHS CSA File No. 022086 CSA Class No. 1437-01 NA Certification UL Listed, CSA certified
	NZM2(-4) PN2(-4), N(S)2(-4)	NZM2-XMV 281582				
	NZM3(-4) PN3(-4), N(S)3(-4)	NZM3-XMV 281583				
	NZM4(-4) N(S)4(-4)	NZM4-XMV 281584				
Bowden cables						
For mechanical interlock for (door coupling) rotary handles						
	Length: 225 mm Length: 600 mm Length: 1000 mm NZM1(-4), PN1(-4), N(S)1(-4) NZM2(-4), PN2(-4), N(S)2(-4) NZM3(-4), PN3(-4), N(S)3(-4) NZM4(-4), N(S)4(-4)	NZM-XBZ225 281585 NZM-XBZ600 281586 NZM-XBZ1000 281587		1 off 	Selection and combinations of Bowden cables → Engineering	Product Standards UL489; CSA-C22.2 No. 5-09; IEC60947, CE marking UL File No. E140305 UL CCN DIHS CSA File No. 022086 CSA Class No. 1437-01 NA Certification UL Listed, CSA certified
Mechanical interlock for remote operator						
For 2 switches of the same or different construction size with opposed operation. Adjacent mounting.						
	NZM2(-4), N(S)2(-4) +NZM2(-4), N(S)2(-4) NZM2(-4), N(S)2(-4) +NZM3(-4), N(S)3(-4) NZM3(-4), N(S)3(-4) +NZM3(-4), N(S)3(-4) NZM3(-4), N(S)3(-4) +NZM4(-4), N(S)4(-4) NZM4(-4), N(S)4(-4) +NZM4(-4), N(S)4(-4)	NZM2-XMVR 104543 NZM2/3-XMVR 104544 NZM3-XMVR 104545 NZM3/4-XMVR 104546 NZM4-XMVR 104547		1 off	Contains parts for both switch sides. Extension shaft additionally required. Maximum switch spacing → Engineering Can not be combined with rotary handles, door coupling rotary handles, early-make auxiliary contacts, and direct-switching remote operator NZM2-XRD.	
For 2 switches of the same or different construction size with opposed operation. Extra long Bowden cable for mounting one above the other or in adjacent enclosures.						
	NZM2(-4), N(S)2(-4) +NZM2(-4), N(S)2(-4) NZM2(-4), N(S)2(-4) +NZM3(-4), N(S)3(-4) NZM3(-4), N(S)3(-4) +NZM3(-4), N(S)3(-4) NZM3(-4), N(S)3(-4) +NZM4(-4), N(S)4(-4) NZM4(-4), N(S)4(-4) +NZM4(-4), N(S)4(-4)	NZM2-XMVRL 104548 NZM2/3-XMVRL 104549 NZM3-XMVRL 104550 NZM3/4-XMVRL 104551 NZM4-XMVRL 104552		1 off	Contains parts for both switch sides. Extension shaft additionally required. Maximum switch spacing → Engineering Can not be combined with rotary handles, door coupling rotary handles, early-make auxiliary contacts, and direct-switching remote operator NZM2-XRD.	

HPL17131EN

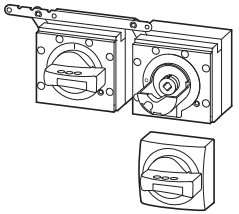
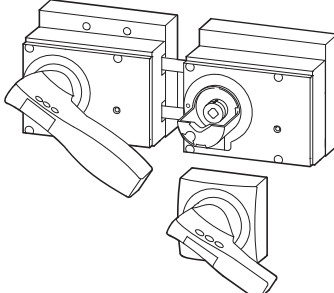
	For use with	Part no. Article no. for separate order	Price See price list	Std. pack	Notes	Information relevant for export to North America 
Paralleling mechanism						
Simultaneous actuation of 2 PN switch-disconnectors of the same type mounted side-by-side. Not UL/CSA approved						
	PN1(-4) + PN1(-4)	PN1-XPA 283471		1 off	PN1, PN2 • 1 × rotary handle on switch (-XD) supplied. • 1 × door coupling rotary handle (-XTVD) supplied.	-
	PN2(-4) + PN2(-4)	PN2-XPA 283472				
	PN3(-4) + PN3(-4)	PN3-XPA 283473			PN3 • 1 × rotary handle on switch (not lockable) supplied. • 1 × door coupling rotary handle (not lockable) supplied. • Not suitable for use as a main switch.	

Notes

Extension shaft (-XV4(6)) additionally required for the door coupling rotary handle.
Cannot be combined with mechanical interlock, insulating surrounds, side wall operators or remote operators.



For use as emergency switching off device

For this the door coupling rotary handle requires an exchange thumb-grip in red/yellow according to the following order number:

- for PN1 and PN2: NZM2-XDGVR → 100747
- for PN3: NZM4-XDGVR → 100774

Note: The locking function of these handles must not be used.

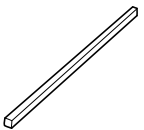
Extension shaft

	400 mm max. built-in depth	NZM1(-4), PN1(-4), N(S)1(-4)	NZM1/2-XV4 261232	1 off 	Length 290 mm, can be cut to required length.	UL/CSA certification not required
		NZM2(-4), PN2(-4), N(S)2(-4)	NZM3/4-XV4 261234			
	600 mm max. built-in depth	NZM1(-4), PN1(-4), N(S)1(-4)	NZM1/2-XV6 260191		Length 425 mm, can be cut to required length.	
		NZM2(-4), PN2(-4), N(S)2(-4)	NZM3/4-XV6 260193			

Notes



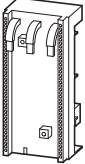
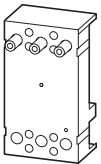
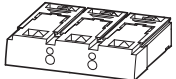
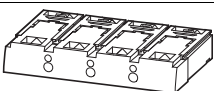

Circuit-breaker can also be installed in a lying position 90° left/right, with the handle still in the same position.

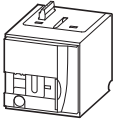

		Number of poles	Rated operational current I_e A	Adapter width mm	For use with	Part no. suffix Article no. for ordering with basic device	Price See price list
Component adapters for circuit-breakers and switch-disconnectors							
For mounting on flat copper bars 12–30x5–10 mm, double T and triple T profile							
Rated operating voltage U_n : 690 V							
<ul style="list-style-type: none"> • Temperature resistant to 120 °C • Self-extinguishing to UL 94 • Track resistance CTI 200 							
	3 pole		160	90	NZM1, PN1, N(S)1	–	
			250	106	NZM2, PN2, N(S)2	–	
			630	140	NZM3, PN3, N(S)3	–	
	4 pole		250	140	NZM2-4, PN2-4, N2-4	–	
			630	185	NZM3-4, PN3-4, N3-4	–	
Connection block for component adapters							
For NZM2, NZM3 circuit-breakers							
	3 pole	Above	250	–	NZM2, PN2, N(S)2	+NZM2-XKR40 281664	
		Below		–	NZM2, PN2, N(S)2	+NZM2-XKR4U 281665	
		Above	630	–	NZM3, PN3, N(S)3	+NZM3-XKR130 281667	
		Below		–	NZM3-4, PN3-4, N(S)3-4	+NZM3-XKR13U 115796	
	4 pole	Above	250	–	NZM2-4, PN2-4, N(S)2-4	+NZM2-4-XKR40 118905	
		Below		–	NZM3, PN3, N(S)3	+NZM2-4-XKR4U 118906	
		Above	630	–	NZM3-4, PN3-4, N(S)3-4	+NZM3-4-XKR130 118908	
		Below		–	NZM2-4, PN2-4, N(S)2-4	+NZM3-4-XKR13U 118909	

Part no. Article no. for separate order	Price See price list	Std. pack	Notes	Information relevant for export to North America
NZM1-XAD160 104554		1 off 	For switch and standard connection with box terminal. Connection to the system at top using supplied connection cable. In conjunction with IP2X protection against contact with a finger. Enhanced contact protection on the switch secondary side. Clips onto busbar with combination foot. Combination foot for adjustment to 5 and 10 mm rail thickness, terminal capacity 6 x 9 x 0.8. Rated short-circuit switching capacity 35 kA at 480 V. Mounted by latching onto de-energized busbar.	Product Standards UL508A; CSA-C22.2 No. 14; IEC 60439-1; CE marking UL File No. E300273 UL CCN NMTR, NMTR7 CSA File No. 236217 CSA Class No. 3211-37 NA Certification UL Listed, CSA certified Conditions of Acceptability Refer to approbation report Suitable for Feeder circuits Max. Voltage Rating 600 V AC Degree of Protection Feeder circuits
NZM2-XAD250 104555			Connection to the system possible at top or bottom via connection on rear (+JNZM2-XKR4... Mounting using clamp and screw fixing. Rated short-circuit switching capacity 65 kA at 480 V, 50 kA at 600 V. Mounted by latching onto de-energized busbar.	
NZM3-XAD630 107206			Connection to the system possible at top or bottom via connection on rear (+JNZM3-XKR13... For mounting use claw terminal. Rated short-circuit switching capacity 65 kA at 480 V, 50 kA at 600 V. Mounted by latching onto de-energized busbar.	
NZM2-4-XAD250 138388			Connection to the system possible at top via connection on rear with (+JNZM2-4-XKR4... Mounting using clamp and screw fixing.	
NZM3-4-XAD630 138389			Connection to the system possible at top via connection on rear with (+JNZM3-4-XKR13... Mounting using clamp and screw fixing.	
NZM2-XKR4 281666		1 off 	Part no. and part no. suffix include parts for one switch side at top or bottom (for NZM3 top only). Required with component adapter and switch with connection on rear.	Product Standards UL 489; CSA-C22.2 No. 5-09; IEC 60947-2; CE marking UL File No. E31593 UL CCN DIVQ CSA File No. 022086 CSA Class No. 1432-01 NA Certification UL Listed, CSA certified Specially designed for NA Yes Suitable for Feeder circuits, branch circuits Current Limiting CB Yes Max. Voltage Rating 480Y/277 V Degree of Protection IEC: IP20; UL/CSA Type: -
NZM3-XKR13 281668				
NZM2-4-XKR4 118907				
NZM3-4-XKR13 119020				

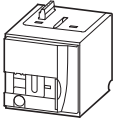

For use with	Rated control voltage U_s V	Part no. Article no. when ordered separately	Price See price list	Std. pack	Notes
Remote operators					
For remote switching of circuit-breakers and switch-disconnectors. ON and OFF switching and resetting by means of two-wire or three-wire control. Local switching by hand possible. Lockable in the 0 position of the remote operator with up to 3 padlocks (hasp thickness: 4 – 8 mm)					
Closing delay 110 – 170 ms, opening delay 110 – 170 ms					
	NZM2(-4) N(S)2(-4)	110-130 V 50/60 Hz	NZM2-XRD110-130AC 115390	1 off 	Sliding switch for "Auto" or "Manual" Max. number auxiliary contacts: - Standard auxiliary contacts: 2 - Trip-indicating auxiliary contact: 1 Cannot be combined with switch-disconnector PN... Cannot be combined with mechanical interlock 1) Not UL/CSA approved
		208-240 V 50/60 Hz	NZM2-XRD208-240AC 115391		
		380-440 V 50/60 Hz ¹⁾	NZM2-XRD380-440AC 115392		
		24-30 V DC	NZM2-XRD24-30DC 115393		
		110-130 V DC	NZM2-XRD110-130DC 115394		
		220-250 V DC	NZM2-XRD220-250DC 115395		
Closing delay 60 – 100 ms, opening delay 300 – 3000 ms					
Can be synchronized					
	NZM2(-4) N(S)2(-4)	110-130 V 50/60 Hz	NZM2-XR110-130AC 259830	1 off 	Cannot be combined with switch-disconnector PN... Dual auxiliary switch M 22-CK11 (20/02) can not be combined with remote operator NZM3-XR...
		208-240 V 50/60 Hz	NZM2-XR208-240AC 259832		
		380-440 V 50/60 Hz	NZM2-XR380-440AC 259834		
		24-30 V DC	NZM2-XR24-30DC 259836		
		48-60 V DC	NZM2-XR48-60DC 259838		
		110-130 V DC	NZM2-XR110-130DC 259840		
	220-250 V DC	NZM2-XR220-250DC 259842			
	NZM3(-4) N(S)3(-4)	110-130 V 50/60 Hz	NZM3-XR110-130AC 259848		
		208-240 V 50/60 Hz	NZM3-XR208-240AC 259850		
		380-440 V 50/60 Hz	NZM3-XR380-440AC 259852		
		24-30 V DC	NZM3-XR24-30DC 259854		
		48-60 V DC	NZM3-XR48-60DC 259856		
110-130 V DC		NZM3-XR110-130DC 259858			
NZM4(-4) N(S)4(-4)	110-130 V 50/60 Hz	NZM4-XR110-130AC 266684			
	208-240 V 50/60 Hz	NZM4-XR208-240AC 266685			
	380-440 V 50/60 Hz	NZM4-XR380-440AC 266686			
	24-30 V DC	NZM4-XR24-30DC 266691			
	48-60 V DC	NZM4-XR48-60DC 266692			
	110-130 V DC	NZM4-XR110-130DC 266693			
220-250 V DC	NZM4-XR220-250DC 266694				

Notes

Two- and three-wire control, circuit diagram → Engineering, Page 17/153



Information relevant for export to North America



Product Standards	UL489; CSA-C22.2 No. 5-09; IEC60947, CE marking
UL File No.	E140305
UL CCN	DIHS
CSA File No.	022086
CSA Class No.	1437-01
NA Certification	UL Listed, CSA certified

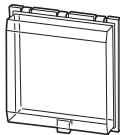

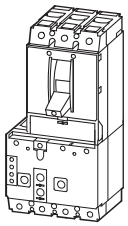

HPL17135EN

	For use with	Part no. Article no. when ordered separately	Price See price list	Std. pack	Notes
Cover for 4th pole					
Additional shroud for mounting the NZM2-XR... and NZM3-XR... on a 4 pole switch	NZM2-4 N2-4	NZM2-XAVPR 266677		1 off	–
	NZM3-4 N3-4	NZM3-XAVPR 266678		1 off	
Sealing device for "Auto" position					
Manual operation possible only after removing seal	NZM2(-4) N(S)2(-4)	NZM2-XRDPL 137305		1 off	Suitable for remote operator NZM2-XRD
Protective cover for door cutout					
	NZM2-XR NZM3-XR NZM4-XR	RTR-NZM10 034825		1 off	Electrical remote switching and manual tripping (push to trip) are still possible.

Number of poles	Rated current = Rated uninterrupted current I_u A	Setting range		High switching capacity 150 kA; 415 V 50/60 Hz Part no. Article no. B = box terminals S = screw terminals	Price See price list	Std. pack	
		Overload releases I_r A 	Short-circuit releases I_i A 				
Circuit-breakers with earth-fault release, 3 pole For apparatus with power electronics, such as power inverters and frequency inverters							
 AC/DC sensitive according to core-balance principle in range of 0 – 100 kHz residual-current frequency. Not UL/CSA approved. Suitable for use in three-phase systems. Rated operating voltage: 400 V (50/60 Hz) Rated fault current $I_{\Delta n} = 0.03$ A Internal power supply $U_g = 50 - 400$ V Turnkey combination of current-limiting circuit-breaker and residual-current device. Adjusting buttons can be sealed.							
	3 pole	125	100-125	750...1250	NZMH2-A125-FIA30 129710	S	1 off
		160	125-160	960...1600	NZMH2-A160-FIA30 112627	S	
		200	160-200	1200...2000	NZMH2-A200-FIA30 112628	S	
		250	200-250	1500...2500	NZMH2-A250-FIA30 112629	S	
		125	100-125	750...1250	NZMH2-A125-FIA30-BT 129711	B	
		160	125-160	960...1600	NZMH2-A160-FIA30-BT 116304	B	
		200	160-200	1200...2000	NZMH2-A200-FIA30-BT 116305	B	
		250	200-250	1500...2500	NZMH2-A250-FIA30-BT 116306	B	

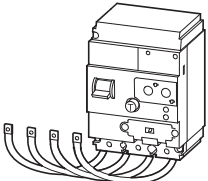
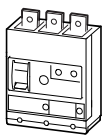
Notes

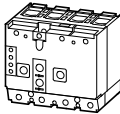
Notes about terminals → Page 17/86

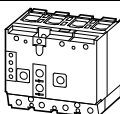
	For use with	Number of conductors	Part no. Article no.	Price See price list	Std. pack	Notes
Earth-fault release						
To IEC/EN 60947-2 Not UL/CSA approved Suitable for use in three- and single-phase systems						
 Pulse-current sensitive according to core-balance principle For 3 and 4 pole NZM1(-4) circuit-breakers and N1(-4) switch-disconnectors, dependant on mains power $U_e = 200 \dots 415 \text{ V } 50/60 \text{ Hz}$						
Mounting on right side up to $I_n = 160 \text{ A}$ at $I_{Cu} = 50 \text{ kA}$						
	Rated fault current $I_{\Delta n} = 0.03 \text{ A}$	NZM1 N(S)1	3 pole	NZM1-XFI30R 104603	1 off	At $I_{\Delta n} = 0.03 \text{ A}$: delay time t_v always fixed at 10 ms. Alarm indication > 30 % $I_{\Delta n}$ by yellow LED. Trip indication by up to 2 auxiliary contacts (HIAFI) can be retrofitted: N/O = M22-K01, NC = M22-K10 are reset with the reset toggle lever. If the trip-indicating auxiliary contact in the fault current block is used, the NC contacts operates as a N/O contact and the NC contact operates as N/O contacts. Double contact not permissible. Not in combination with insulated enclosure or main switch assembly kit for side wall installation with mounting bracket.
		NZM1-4 N1-4	4 pole	NZM1-4-XFI30R 104606		
	Rated fault current $I_{\Delta n} = 0.3 \text{ A}$	NZM1 N(S)1	3 pole	NZM1-XFI300R 104604		
		NZM1-4 N1-4	4 pole	NZM1-4-XFI300R 104607		
	Rated fault current $I_{\Delta n} = 0.03-0.1-0.3-0.5-1-3 \text{ A}$	NZM1 N(S)1	3 pole	NZM1-XFIR 104605		
	Delay time $t_v = 10-60-150-300-450 \text{ ms}$	NZM1-4 N1-4	4 pole	NZM1-4-XFIR 104608		
Mounting below up to 100 A						
	Rated fault current $I_{\Delta n} = 0.03 \text{ A}$	NZM1 N(S)1	3 pole	NZM1-XFI30U 104609	1 off	NZM1-XFI...R can not be used in combination with lower cover NZM1-XKSA. NZM1-XFI...U not in combination with shunt or undervoltage release, early-make auxiliary contacts. Rated ultimate short-circuit breaking capacity is determined by the fitted NZM1 or NS1, or, if a switch-disconnector N1 is used, by the fitted back-up fuse → Technical data. Adjusting buttons can be sealed.
		NZM1-4 N1-4	4 pole	NZM1-4-XFI30U 104612		
	Rated fault current $I_{\Delta n} = 0.3 \text{ A}$	NZM1 N(S)1	3 pole	NZM1-XFI300U 104610		
		NZM1-4 N1-4	4 pole	NZM1-4-XFI300U 104613		
	Rated fault current $I_{\Delta n} = 0.03-0.1-0.3-0.5-1-3 \text{ A}$	NZM1 N(S)1	3 pole	NZM1-XFIU 104611		
	Delay time $t_v = 10-60-150-300-450 \text{ ms}$	NZM1-4 N1-4	4 pole	NZM1-4-XFIU 104614		
Mounting below up to 250 A						
 Pulse-current sensitive according to core-balance principle For 4 pole circuit-breaker NZM2-4 and switch-disconnector N2-4 independent of mains voltage $U_e = 280 \dots 690 \text{ V } 50/60 \text{ Hz}$						
	Rated fault current $I_{\Delta n} = 0.03 \text{ A}$	NZM2-4 N2-4	4 pole	+NZM2-4-XFI30 292343	1 off	Auxiliary contacts (1 N/O, 1 NC built-in) are reset with the reset button. Not in combination with plug-in units, insulated enclosure or main switch assembly kit for side wall installation with mounting bracket. Rated ultimate short-circuit breaking capacity is determined by fitted NZM2 and, when using a switch-disconnector N2, by the back-up fuse used → Technical data. Adjusting buttons can be sealed.
	Rated fault current $I_{\Delta n} 0.1-0.3-1-3 \text{ A}$ Delay time $t_v = 60-150-300-450 \text{ ms}$	NZM2-4 N2-4	4 pole	+NZM2-4-XFI 292344	1 off	
  Core-balance principle with AC/DC current sensitivity (in range 0 ... 100 kHz) For 4 pole circuit-breaker NZM2-4 and switch-disconnector N2-4 Internal voltage supply $U_e = 50 \dots 400 \text{ V}$						
	Rated fault current $I_{\Delta n} = 0.03 \text{ A}$	NZM2-4 N2-4	4 pole	+NZM2-4-XFIA30 292345	1 off	Observe response threshold dependence on frequency! See "Frequency response" characteristic curve. Adjusting buttons can be sealed.
	Rated fault current $I_{\Delta n} 0.3-0.5-1 \text{ A}$ Delay time $t_v = 60-150-300-450 \text{ ms}$	NZM2-4 N2-4	4 pole	+NZM2-4-XFIA 292346	1 off	

HPL17137EN

	For use with	Part no. suffix Article no. for ordering with basic device	Price See price list	Std. pack	Notes
Earth-fault release, 3 pole, 4 pole					
Not dependent on mains and control voltages $I_g = 0.35-0.4-0.5-0.6-0.7-0.8-0.9-1.0 \times I_n$ $t_g = 0-20-60-100-200-300-500-750-1000$ ms	NZM4	+NZM4-XT 266721		1 off	Only suitable for use in conjunction with circuit-breakers with electronic releases. Not in combination with motor-protective circuit-breakers NZM...-ME... Indication of the earth-fault in optional DMI communication module.
	NS4			1 off	
Not UL/CSA approved	NZM4-4	+NZM4-4-XT 266722			

Description	Rated current Energy	Motor I_n A	Part no. Article no.	Price See price list	Std. pack	Notes
-------------	-------------------------	---------------------	-------------------------	----------------------------	-----------	-------

Residual-current relays

Pulsed current sensitive
Rated control voltage: $U_c = 230$ V AC (50/60 Hz)
Integrated auxiliary contact (1 C/O)
Ring-type transformer must also be ordered.
Not UL/CSA approved

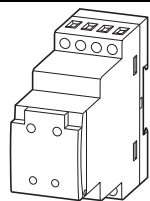

Rated fault current $I_{\Delta N} = 0.03$ A	–	–	PFR-003 285555		1 off	–
Rated fault current $I_{\Delta N} = 0.3$ A	–	–	PFR-03 285556			–
Rated fault current $I_{\Delta N} = 0.03-5$ A Adjustable fault current and delay time Fault current early warning by flashing, red LED	–	–	PFR-5 285557			Adjustable fault current: 0.03, 0.1, 0.3, 0.5, 1, 3, 5 A Adjustable delay time: 0.02, 0.1, 0.3, 0.5, 1, 3, 5 A
–	–	–	PFR-5-110AC 116963			–

Ring-type transformer

Rated operating voltage: 690 V (50/60 Hz)
Not UL/CSA approved



Internal diameter: 20 mm	50	50	PFR-W-20 285558		1 off	Includes fixing clip for DIN rail mounting
Internal diameter: 30 mm	150	100	PFR-W-30 285559			

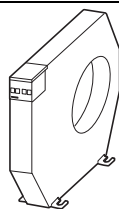

Internal diameter: 35 mm	150	100	PFR-W-35 285600		1 off	Includes screw fixing Alternative: fixing clip for DIN mounting rail Note on engineering: The current transformer diameter must be selected 1.5 times larger than the envelope diameter of the passed through conductor.
Internal diameter: 70 mm	400	200	PFR-W-70 285601			
Internal diameter: 105 mm	600	250	PFR-W-105 285602			
Internal diameter: 140 mm	1200	630	PFR-W-140 285603			
Internal diameter: 210 mm	1800	800	PFR-W-210 285604			

Magnetic shielding

Not UL/CSA approved

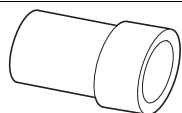

PFR-W-35	–	–	PFR-WMA-35 286001		1 off	Required for load circuits with high inrush currents > $4 \times I_n$, e.g. motors and capacitors.
PFR-W-70	–	–	PFR-WMA-70 286002			
PFR-W-105	–	–	PFR-WMA-105 286003			
PFR-W-140	–	–	PFR-WMA-140 286004			
PFR-W-210	–	–	PFR-WMA-210 286005			

Mounting clip

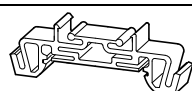

For the DIN rail mounting current transformers PFR-W-35 and larger	–	–	PFR-WC 286006		1 off	1 set = 2 off
--	---	---	-------------------------	--	-------	---------------

Description

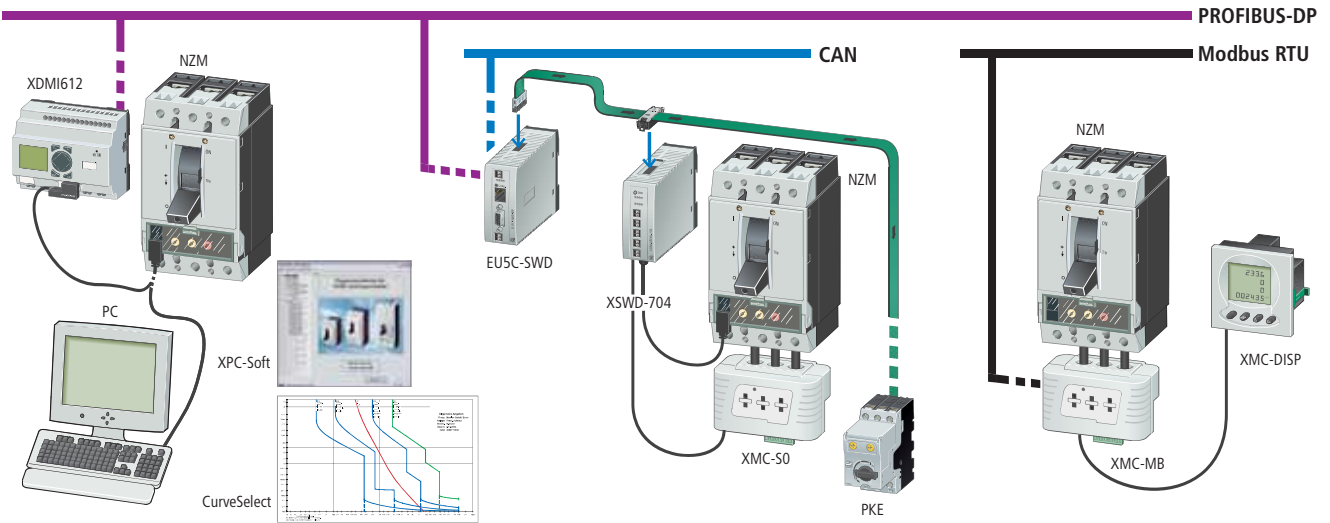

Overview

For the compact circuit-breakers NZM Eaton supplies the following energy measurement and communication components:

- NZM-XPC-Soft: Diagnostics software
- CurveSelect: Software for viewing characteristic curves
- NZM-XMC-S0: Energy measuring module
- NZM-XMC-MB: Measuring and communication module
- NZM-XSWD-704: Communication interface for SmartWire-Darwin with S0 input for energy data
- NZM-XDMI612: Data management interface with field bus connection for PROFIBUS-DP and bus diagnostics software

XPC-Soft

Circuit-breakers NZM with electronic trip block provide all required diagnostics data directly to the USB or COM interface of a connected PC through a built-in interface. On overload or short-circuit, the NZM instantly switches off the system and, if a PC is connected, documents the events complete with date and time. With the software XPC-Soft, users can view the history and analyze possible causes. The software can also output power consumption trend graphs as MS Excel table.

CurveSelect

The free characteristic curve program Moeller CurveSelect allows a settings-specific representation of the tripping characteristics of several protective devices with the same time and current scales. This clearly simplifies an assessment of the interaction of Eaton's circuit-breakers NZM and IZM, motor-protective circuit-breakers PKZ, overload relays ZB, miniature circuit-breakers, and LV h.b.c. fuses. Available for free download from www.moeller.net: Products & Solutions > Power Distribution > Switching and Protecting Power > CurveSelect: Characteristics program for short-circuit- and overload protection.

Measuring and communication module

For measuring and optimizing energy consumption, Eaton provides module NZM-XMC. This compact device with built-in current converter determines the power and energy values per phase from the measured voltage and current. The module can operate the circuit-breaker through a remote operator. The data is made available on the MODBUS RTU. With the XMC applications up to 500 A can be operated; the readings have a high accuracy of 0.5 %. Cables, strip or bar can be used. The conductors pass through a tunnel in the device and do not have to be severed. An optional external door display provides real-time local indication of the measured values.

Communication interface for SmartWire-Darwin



For remote diagnostics of the circuit-breaker, communication module NZM-XSWD-704 is used. With this module, the switch settings, trip causes, and actual currents can be transmitted to a field bus through SmartWire-Darwin. The circuit-breaker can therefore also be operated through SmartWire-Darwin, like the electronic motor protection PKE and the typical devices such as RMQ and DIL. As a special feature, the XSWD features a built-in power meter, which can be supplied from an external energy measurement module XMC-S0. This provides everything that is necessary for optimizing energy usage. With the data from the XSWD-704 all relevant information about energy supply or the respective outgoer on the desired field bus are available. This allows visualization and logging of the machines or system components. For visualization, the free software BreakerVisu can, for example, be used, available for download from www.moeller.net: Products & Solutions > Power Distribution > Switching and Protecting Power Distribution > Moeller BreakerVisu: Visualization for circuit-breakers

Data Management with PROFIBUS-DP interface

An alternative to the XSWD-704 is provided by data management interface NZM-XDMI612 with a field bus connection for PROFIBUS-DP.

The advantages of this solution are:

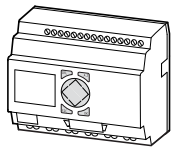
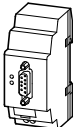
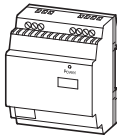
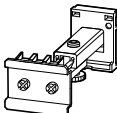
- For motor starter applications a ZMR function is available that does not trip the circuit-breaker in the event of an overload but that deactivates the contactor through the DMI.
- The built-in display provides a local indication of all parameters of the circuit-breaker.
- The DMI can change the circuit-breakers' tripping parameters. (remote parameterization)
- The DMI's six inputs and six outputs can be used for remote control and for any user functions.
- Through the outputs a "Tripped" signal can be issued locally.
- A central diagnosis across the entire bus to the FDT standard can be implemented through the DMI with the DPV1 module. For this purpose, software NZM-XPC-DTM and, in some cases, FDT-FAVIGATOR are required.

Description	Part no. Article no.	Price See price list	Std. pack	Notes
Diagnostics and configuration software for NZM and DMI (local)				
<p>PC software for direct connection to all new NZM circuit-breakers with electronic releases (IEC and UL/CSA devices) or for direct connection to the DMI module, including the required connection cable to NZM.</p> <ul style="list-style-type: none"> Protection parameter: online display and curve display, export option to curve characteristics program "Moeller CurveSelect". Warning and release messages: reading of diagnostic memory also in voltage-free state. Load currents: display and trend indication. Recording and export options to Excel for load currents and diagnostic messages. Configuration of the DMI: motor starter, remote operator, assignment of the DMI inputs and outputs and displays. 	NZM-XPC-KIT 265631		1 off	<p>Only for use in combination with circuit-breakers with electronic releases.</p> <p>Download the manual AWB1230-1459 and demo-software at www.moeller.net.</p> <p>Order connecting cable to DMI separately: EASY-USB-CAB.</p>
Connecting cable PC (USB) to DMI				
 <ul style="list-style-type: none"> For transmission of DMI configuration between PC with XPC-Soft and DMI For upgrading DMI firmware 	EASY-USB-CAB 107926		1 off	Can also be used for programming easy small controllers.
Data management interface (DMI module)				
 <ul style="list-style-type: none"> Access to diagnostics and operational data. Recording current values, motor starter function, and setting parameters. Control of the circuit-breakers with electronic trip block. Comprehensive remote diagnostic options and remote operation via fieldbus in combination with a field Bus connection. 	NZM-XDMI612 260217		1 off	<p>Includes connection cable NZM-XDMI-CAB between NZM and DMI (length: 2 m).</p> <p>Only for use in combination with circuit-breakers with electronic releases.</p>
Fieldbus interface for DMI				
 <p>Connection to the DMI module</p> <ul style="list-style-type: none"> Transfer of phase currents, parameter data, status data and diagnostics data. Transfer of circuit-breaker position (wiring of auxiliary contacts to DMI inputs). Actuation of the DMI motor starter functions and the NZM remote operator. Detection of digital inputs and actuation via field Bus. PROFIBUS-DPV1-Slave fieldbus interface. Can be operated with class 1 and class 2 masters. Addresses available: 1 to 126. 	NZM-XDMI-DPV1 270333		1 off	Connected to the DMI module and has the same contour appearance.
Switched-mode power supply unit				
<p>For DMI module</p>  <ul style="list-style-type: none"> Rated input voltage: 50/60 HZ: 115/230 V AC Rated output voltage (residual ripple): 24 V DC (± 3 %) Rated output current: 1.25 A 	EASY400-POW 212319		1 off	-
Telescopic adapter				
<p>For DMI module</p> <p>For equalization of the mounting depth when rear mounted in CI-K... enclosures and cabinets.</p>  <p>With 35 mm top-hat rail IEC/EN 60715, adjustable from 75 – 115 mm. Screw and snap fitting.</p>	M22-TA 226161		1 off 	-



Information relevant for export to North America





Product Standards

IEC/EN 60947-5; UL 508; CSA-C22.2 No. 14-05; CSA-C22.2 No. 94-91; CE marking
UL File No. E29184
UL CCN NKCR
CSA File No. 012528
CSA Class No. 3211-03
NA Certification UL Listed, CSA certified



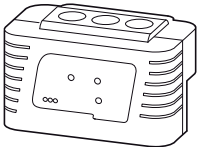
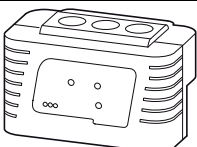

Description	Part no. Article no.	Price See price list	Std. pack	Notes
FDT frame software for operating field devices				
 <p>PC software for integration of software modules (DTM's) according to the FDT standard V1.2 (e.g. NZM-XPC-DTM).</p> <ul style="list-style-type: none"> • Operation of a temporary or stationary service station for engineering, remote diagnostics, remote operation and remote parameter definition of networked switchgear and field devices. • Engineering of the network topology of networked field devices. • Overview representation of the topology with online status information. • Access to the device-specific DTM's for configuration, operation, parameterization and diagnostics of the devices. • Storage of all engineering information in a central database. Download and upload from/to the devices. 	<p>FDT-NAVIGATOR 281623</p>		1 off	<p>The connection of the field devices can be implemented via the PROFIBUS DPV1 master or via gateways (e.g.: USB/PROFIBUS, Ethernet/PROFIBUS). Communication interfacing for the PC and a communication DTM (driver) is necessary for this purpose.</p>
DTM software module to FTD standard				
 <p>PC software module (Device Type Manager) to FDT/DTM standard V1.2 for integration in the FDT navigator or other FDT-capable framework software packages (primary control system, PLC engineering systems).</p> <ul style="list-style-type: none"> • Remote diagnostics, remote monitoring, remote parameter definition and remote operation of the new NZM2.3.4 circuit-breakers with electronic trip release via PROFIBUS-DPV1. • Indication of the circuit-breaker state (on/off/tripped), the phase currents, parameter data, status data and diagnostics data. • Definition of the trip parameters. • Display and setting the DMI motor starter functions and assignment of the DMI inputs and outputs. • Control of the motor starter functions. 	<p>NZM-XPC-DTM 281624</p>		1 off	<p>For connection of the circuit-breaker to the PROFIBUS-DP fieldbus, the accessory device NZM-XDMI612 and the fieldbus interface NZM-XDMI-DPV1 are required.</p>
NZM interface module to SmartWire-Darwin				
 <p>The module implements the data connection between the NZM2/3/4 with electronic release and SmartWire-Darwin. The following data is transmitted:</p> <ul style="list-style-type: none"> • Digital status data (ON/OFF/Tripped) • Load warnings • Reason for last trip • The actual currents • Switch model • The current settings of the rotary coding switches <p>The switch can also be operated with a remote operator.</p> <ul style="list-style-type: none"> • Two digital inputs for the switch status • Two transistor outputs for remote switching • Retentive memory for energy data (kWh) <p>Energy data is transmitted through digital input (S₀) from an external energy measuring module NZN...-XMC-S0.</p>	<p>NZM-XSWD-704 135530</p>		1 off	<p>A connection cable to the circuit-breaker and auxiliary contacts NZM is included as standard.</p>



	Number of conductors	Description	For use with	Part no. Article no.	Price See price list	Std. pack	Notes
Energy measuring module							
For measuring the electrical active energy. The module has three built-in current transformers and three voltage taps, which are contacted with self-tapping screws that penetrate the cable insulation. Power supply 24 VDC The module supplies SO pulses, which can be counted with an external device. One pulse output for active energy. The pulse rate is fixed.							
	3 pole	–	NZM 2 ≤ 300 A	NZM2-XMC-SO 129839		1 off	When mounting, observe the minimum clearances to circuit-breaker NZM. The module can be fitted on the input or output side.
		–	NZM 3 ≤ 500 A	NZM3-XMC-SO 129960		1 off	
	4 pole	–	NZM 2 ≤ 300 A	NZM2-4-XMC-SO 129963		1 off	
		–	NZM 3 ≤ 500 A	NZM3-4-XMC-SO 129964		1 off	
Measuring and communication module							
For measuring current, voltage, power and energy. The module has three built-in current transformers and three voltage taps, which are contacted with self-tapping screws that penetrate the cable insulation. Power supply 24 VDC Two SO pulse outputs MODBUS interface (slave) The total energy consumption value is permanently stored in the module. Display device NZM-XMC-DISP can be connected for local indication of the readings. Can be extended with up to two add-on cards +NZM-XMC.							
	3 pole	–	NZM 2 ≤ 300 A	NZM2-XMC-MB 129961		1 off	When mounting, observe the minimum clearances to circuit-breaker NZM. The module can be fitted on the input or output side.
		–	NZM 3 ≤ 500 A	NZM3-XMC-MB 129962		1 off	
	4 pole	–	NZM 2 ≤ 300 A	NZM2-4-XMC-MB 129965		1 off	
		–	NZM 3 ≤ 500 A	NZM3-4-XMC-MB 129966		1 off	
Digital display device							
For door-mounting (connection to local display) For all measurement and communication modules with MODBUS interface Per-phase indication of current, voltage, power and energy values Includes fixed display configurations							
	3/4 pole	Front cutout 96 × 96 knockout	NZM...XMC-MB	NZM-XMC-DISP 129967		1 off	–
Power supply							
Power supply 230 V AC							
	3/4 pole	Can be plugged onto basic device	NZM...XMC-MB	NZM-XMC-AC 129968		1 off	–
Add-on cards for NZM-XMC modules							
Every measurement and communication module can be equipped with up to two expansion cards.							
		MODBUS interface	–	+NZM-XMC-MB 135524		1 off	Order add-on cards together with basic device. The cards are then supplied readily fitted in the basic device.
		Analog output for 4–20 mA pointer-type instruments	–	+NZM-XMC-1AO 135525		1 off	
		2 relay outputs (changeover contact)	–	+NZM-XMC-2DO-R 135526		1 off	
		4 relay outputs (changeover contact)	–	+NZM-XMC-4DO-R 135527		1 off	
		4 digital inputs and 4 digital outputs	–	+NZM-XMC-4DI-4DO 135528		1 off	

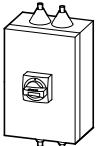
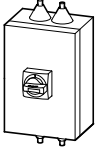

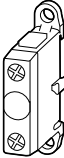
	Degree of protection	Max. rated uninterrupted current I_u A	For use with	Part no. Article no. when ordered separately	Price See price list	Std. pack
Insulated enclosures						
With door coupling rotary handle Complete includes all necessary functional parts Not UL/CSA approved						
Standard, black/grey						
	Lockable in 0 position on handle with up to 3 padlocks. Additionally with cover interlock.	IP65	≤ 63 A	PN1, N(S)1	NZM1-XCIK5-TVD 271521	1 off
		IP65	≤ 63 A	NZM1, PN1, N(S)1	NZM1-XCI23-TVD 271522	1 off
		IP64	≤ 125 A	NZM1(-4), PN1(-4), N(S)1(-4)	NZM1-XCI43-TVD 271523	1 off
		IP64	≤ 160 A	NZM1(-4), PN1(-4), N(S)1(-4)	NZM1-XCI43/2-TVD 104645	1 off
		IP64	≤ 200 A	NZM2(-4), PN2(-4), N(S)2(-4)	NZM2-XCI43-TVD 271524	1 off
		IP64	≤ 250 A	NZM2(-4), PN2(-4), N(S)2(-4)	NZM2-XCI45-TVD 280418	1 off
		IP64	≤ 400 A	NZM3(-4), PN3(-4), N(S)3(-4)	NZM3-XCI48-TVD 271525	1 off
Red-yellow for emergency switching off						
	Lockable on handle and switch with up to 3 padlocks. Lockable in 0 position on handle. Additionally with cover interlock and locking facility on circuit-breaker in 0 position.	IP65	≤ 63 A	PN1, N(S)1	NZM1-XCIK5-TVDVR 271526	1 off
		IP65	≤ 63 A	NZM1, PN1, N(S)1	NZM1-XCI23-TVDVR 271527	1 off
		IP64	≤ 125 A	NZM1(-4), PN1(-4), N(S)1(-4)	NZM1-XCI43-TVDVR 271528	1 off
		IP64	≤ 160 A	NZM1(-4), PN1(-4), N(S)1(-4)	NZM1-XCI43/2-TVDVR 104646	1 off
		IP64	≤ 200 A	NZM2(-4), PN2(-4), N(S)2(-4)	NZM2-XCI43-TVDVR 271529	1 off
		IP64	≤ 250 A	NZM2(-4), PN2(-4), N(S)2(-4)	NZM2-XCI45-TVDVR 279356	1 off
		IP64	≤ 400 A	NZM3(-4), PN3(-4), N(S)3(-4)	NZM3-XCI48-TVDVR 271530	1 off

	Rated uninterrupted current I_u A	Terminal capacity mm ²	Part no. Article no. when ordered separately	Price See price list	Std. pack
Insulated additional terminals					
For passing through the neutral and protective conductor 1 pole					
	32	Flexible, 1 × (1.5 – 6)	K10/1 093827		10 off
	63	Flexible, 1 × (6 – 16), stranded, 1 × (16 – 25)	K25/1 096200		10 off
	100	Flexible, 1 × (10 – 35), stranded, 1 × (16 – 50)	K50/1 098573		10 off
	160	Stranded, 1 × (16 – 95)	K95/1N/BR 012336		1 off
	250	Stranded, 1 × (35 – 150), 2 × (16 – 70)	K150/1/BR 014709		1 off
	400	Stranded, 1 × (50 – 240), 2 × (25 – 120)	K240/1/BR 017082		1 off
	630	Stranded, 1 × (240 – 300), 2 × (50 – 240)	K2X240/1/BR 019455		1 off

Basic enclosure

Terminals for 3-pole switches fitted by user:
for fourth and fifth conductor (N and PE),
on 4 pole switches: for fifth conductor (PE)**Notes**

CI-K5-160-M	K10/1, K25/1	<p>Enclosures for separate mounting with top and bottom cable entry, suitable for installation of circuit-breakers and switch-disconnectors. Include fixing straps for wall mounting. Short-circuit resistance at 415 V 50/60 Hz up to 10 kA.</p> <p>Cannot be used in combination with remote operator NZM...-XR..., plug-in unit NZM...-XSV or withdrawable unit NZM...-XAV. Order insulated additional terminal for 4th or 5th pole separately.</p> <p>Enclosure CI-K5 with hard metric knock-outs Enclosure CI23 with flanges CI43, CI45 and CI48 feature gland plates.</p> <p>Only for switches with box terminals for direct connection of cables.</p>
CI23-150	K10/1, K25/1	
CI43-150	K10/1, K25/1, K50/1, K95/1N/BR	
CI43-200	K10/1, K25/1, K50/1, K95/1N/BR	
CI43-200	K10/1, K25/1, K50/1, K95/1N/BR, K150/1/BR, K240/1/BR	
CI45-200	K10/1, K25/1, K50/1, K95/1N/BR, K150/1/BR, K240/1/BR	
CI48-250	K95/1N/BR, K150/1/BR, K240/1/BR, K2X240/1/BR	
CI-K5-160-M	K10/1, K25/1	
CI23-150	K10/1, K25/1	
CI43-150	K10/1, K25/1, K50/1, K95/1N/BR	
CI43-200	K10/1, K25/1, K50/1, K95/1N/BR	
CI43-200	K10/1, K25/1, K50/1, K95/1N/BR, K150/1/BR, K240/1/BR	
CI45-200	K10/1, K25/1, K50/1, K95/1N/BR, K150/1/BR, K240/1/BR	
CI48-250	K95/1N/BR, K150/1/BR, K240/1/BR, K2X240/1/BR	



Engineering

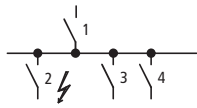

Incoming circuit-breaker
Outgoing circuit-breaker

Selectivity 415 V AC

between circuit-breakers enables separate shut-down of faulty system sections.
Selectivity (discrimination) exists between incoming circuit-breaker 1 and outgoing circuit-breaker 2 if, only outgoing breaker 2 trips at position 2 during a short-circuit.
System sections 3 and 4 continue to operate.

Incoming circuit-breaker (S1)

NZM...1-A...

NZM...2-A...

Outgoing circuit-breaker (S2)	I_{cu} [kA]	I_n [A]	25(36)(50)(100)							25(36)(50)(150)										
			20-40	50	63	80	100	125	160	20-40	50	63	80	100	125	160	200	250	300	
Selectivity threshold I_s [kA] for selectivity between S2 and S1, overload and short-circuit release set to max. value																				
FAZ-B(C)	0.5	15	T	T	T	T	T	T	T	T	T	T	T	T	T	T	T	T	T	
	1	15	T	T	T	T	T	T	T	T	T	T	T	T	T	T	T	T	T	
	2	15	2	T	T	T	T	T	T	T	3	T	T	T	T	T	T	T	T	
	3	15	1.2	2	3	3	10	T	T	1.5	1.5	3	5	T	T	T	T	T	T	
	4	15	1.2	2	3	3	8	T	T	1.2	1.5	3	4	T	T	T	T	T	T	
	6	15	1.2	2	2.5	3	5	10	10	1.2	1.5	2.5	3	T	T	T	T	T	T	
	10	15	1.2	1.5	2	2	4	10	10	1	1.5	2.5	3	10	10	10	10	10	10	
	13	15	1	1.5	2	2	4	10	10	1	1.2	2	3	10	10	10	10	10	10	
	16	15	1	1.2	1.5	2	3	8	8	1	1.2	1.5	2.5	10	10	10	10	10	10	
	20	15	0.8	1.2	1.5	1.5	3	8	8	1	1.2	1.5	2.5	10	10	10	10	10	10	
	25	15	0.7	1.2	1.5	1.5	3	7	7	0.8	1	1.5	2	10	10	10	10	10	10	
	32	15	-	1.2	1	1.5	2	6	6	-	1	1.5	2	8	8	8	8	10	10	
	40	15	-	-	1	1.5	2	5	5	-	-	1.2	1.5	7	7	7	7	10	10	
50	15	-	-	-	1.2	1.5	4	4	-	-	-	1.5	6	6	6	6	10	10		
63	15	-	-	-	-	1.5	3	3	-	-	-	-	6	6	6	6	10	10		
PKZM0-...	0.16	100	T	T	T	T	T	T	T	T	T	T	T	T	T	T	T	T	T	
	0.25	100	T	T	T	T	T	T	T	T	T	T	T	T	T	T	T	T	T	
	0.4	100	T	T	T	T	T	T	T	T	T	T	T	T	T	T	T	T	T	
	0.63	100	T	T	T	T	T	T	T	T	T	T	T	T	T	T	T	T	T	
	1	100	T	T	T	T	T	T	T	T	T	T	T	T	T	T	T	T	T	
	1.6	100	T	T	T	T	T	T	T	T	T	T	T	T	T	T	T	T	T	
	2.5	100	T	T	T	T	T	T	T	T	T	T	T	T	T	T	T	T	T	
	4	100	T	T	T	T	T	T	T	T	T	T	T	T	T	T	T	T	T	
	6.3	100	4	5	5	T	T	T	T	2	3	4	5	T	T	T	T	T	T	
	10	100	3	4	5	6	25	T	T	1.5	2.5	4	4	T	T	T	T	T	T	
	12	50	3	4	5	6	25	T	T	1.5	2.5	4	4	T	T	T	T	T	T	
	16	50	1.5	1.5	2	3	5	7	T	1	1.6	2	2.5	T	T	T	T	T	T	
	20	50	0.8	1.5	1.5	2	3	5	T	0.8	1.2	1.5	2	T	T	T	T	T	T	
25	50	-	1	1.5	1.5	2.5	4	T	-	1	1.5	2	10	T	T	T	T	T		
32	50	-	-	1	1	2	3.5	T	-	-	1	1.5	8	40	T	T	T	T		
PKZ2/ZM-...	0.6	100	T	T	T	T	T	T	T	T	T	T	T	T	T	T	T	T	T	
	1.0	100	T	T	T	T	T	T	T	T	T	T	T	T	T	T	T	T	T	
	1.6	100	T	T	T	T	T	T	T	T	T	T	T	T	T	T	T	T	T	
	2.4	100	1.2	2	2.5	10	T	T	1.2	2	2.5	10	T	T	T	T	T	T	T	
	4	100	1	1.5	2	2.5	2.5	4	10	1	1.5	2	2.5	2.5	10	10	10	10	10	
	6	100	0.6	0.8	1	1.2	2	3	8	0.6	0.8	1	1.2	2	8	8	8	10	10	
	10	100	0.5	0.7	0.8	1	1.2	2	4	0.5	0.7	0.8	1	1.2	4	4	4	5	5	
	16	100	0.5	0.6	0.7	0.8	1.2	1.5	3	0.5	0.6	0.7	0.8	1.2	3	3	3	4	4	
	25	30	-	0.6	0.7	0.7	1.2	1.5	2	-	0.6	0.7	0.7	1.2	2	2	2	3	3	
	32	30	-	-	0.6	0.7	1.2	1.5	2	-	-	0.6	0.7	1.2	2	2	2	3	3	
	40	30	-	-	0.6	0.7	1	1.5	2	-	-	0.6	0.7	1	2	2	2	2	2	
	PKZM4	16	100	0.5	0.8	0.8	0.8	2	5	5	0.5	0.8	0.8	0.8	2	5	5	5	5	5
		25	100	-	0.7	0.8	0.8	1.5	5	5	-	0.7	0.8	0.8	1.5	5	5	5	5	5
32		50	-	-	0.8	0.8	1.5	4	4	-	-	0.8	0.8	1.5	4	4	4	4	4	
40		50	-	-	-	0.8	1.5	3	3	-	-	-	0.8	1.5	3	3	3	3	3	
50		50	-	-	-	-	1	2.5	2.5	-	-	-	-	1	2.5	2.5	2.5	2.5	2.5	
58		50	-	-	-	-	-	2.5	2.5	-	-	-	-	-	2.5	2.5	2.5	2.5	2.5	
63		50	-	-	-	-	-	2	2	-	-	-	-	-	2	2	2	2	2	

Notes

T: total selectivity

Incoming circuit-breaker (S1)

NZM...2-VE...			NZM...3-A...				NZM...3-AE...			NZM...3-VE...			NZM...4-AE...					NZM...4-VE...				
50(150)			36(50)(150)				50(150)			50(150)			50(85)					50(85)				
100	160	250	250	320	400	500	250	400	630	250	400	630	630	800	1000	1250	1600	630	800	1000	1250	1600
Selectivity threshold I_s [kA] for selectivity between S2 and S1, overload and short-circuit release set to max. value																						
T	T	T	T	T	T	T	T	T	T	T	T	T	T	T	T	T	T	T	T	T	T	
T	T	T	T	T	T	T	T	T	T	T	T	T	T	T	T	T	T	T	T	T	T	
T	T	T	T	T	T	T	T	T	T	T	T	T	T	T	T	T	T	T	T	T	T	
T	T	T	T	T	T	T	T	T	T	T	T	T	T	T	T	T	T	T	T	T	T	
T	T	T	T	T	T	T	T	T	T	T	T	T	T	T	T	T	T	T	T	T	T	
10	10	10	10	T	T	T	T	T	T	T	T	T	T	T	T	T	T	T	T	T	T	
10	10	10	10	T	T	T	T	T	T	T	T	T	T	T	T	T	T	T	T	T	T	
10	10	10	10	T	T	T	T	T	T	T	T	T	T	T	T	T	T	T	T	T	T	
10	10	10	10	T	T	T	T	T	T	T	T	T	T	T	T	T	T	T	T	T	T	
10	10	10	10	T	T	T	T	T	T	T	T	T	T	T	T	T	T	T	T	T	T	
8	8	10	10	T	T	T	T	T	T	T	T	T	T	T	T	T	T	T	T	T	T	
7	7	10	10	T	T	T	T	T	T	T	T	T	T	T	T	T	T	T	T	T	T	
6	6	10	10	T	T	T	T	T	T	T	T	T	T	T	T	T	T	T	T	T	T	
6	6	10	10	T	T	T	T	T	T	T	T	T	T	T	T	T	T	T	T	T	T	
T	T	T	T	T	T	T	T	T	T	T	T	T	T	T	T	T	T	T	T	T	T	
T	T	T	T	T	T	T	T	T	T	T	T	T	T	T	T	T	T	T	T	T	T	
T	T	T	T	T	T	T	T	T	T	T	T	T	T	T	T	T	T	T	T	T	T	
T	T	T	T	T	T	T	T	T	T	T	T	T	T	T	T	T	T	T	T	T	T	
T	T	T	T	T	T	T	T	T	T	T	T	T	T	T	T	T	T	T	T	T	T	
T	T	T	T	T	T	T	T	T	T	T	T	T	T	T	T	T	T	T	T	T	T	
T	T	T	T	T	T	T	T	T	T	T	T	T	T	T	T	T	T	T	T	T	T	
T	T	T	T	T	T	T	T	T	T	T	T	T	T	T	T	T	T	T	T	T	T	
T	T	T	T	T	T	T	T	T	T	T	T	T	T	T	T	T	T	T	T	T	T	
T	T	T	T	T	T	T	T	T	T	T	T	T	T	T	T	T	T	T	T	T	T	
10	T	T	T	T	T	T	T	T	T	T	T	T	T	T	T	T	T	T	T	T	T	
8	T	T	T	T	T	T	T	T	T	T	T	T	T	T	T	T	T	T	T	T	T	
T	T	T	T	T	T	T	T	T	T	T	T	T	T	T	T	T	T	T	T	T	T	
T	T	T	T	T	T	T	T	T	T	T	T	T	T	T	T	T	T	T	T	T	T	
T	T	T	T	T	T	T	T	T	T	T	T	T	T	T	T	T	T	T	T	T	T	
10	10	T	T	T	T	T	T	T	T	T	T	T	T	T	T	T	T	T	T	T	T	
8	8	T	10	T	T	T	T	T	T	T	T	T	T	T	T	T	T	T	T	T	T	
4	4	5	5	6	9	T	5	13	T	5	13	T	T	T	T	T	T	T	T	T	T	
3	3	4	4	4	5	30	4	7	T	4	7	T	T	T	T	T	T	T	T	T	T	
2	2	3	3	3	4	10	3	5	20	3	5	20	T	T	T	T	T	T	T	T	T	
2	2	3	3	3	4	8	3	3.5	15	3	3.5	15	T	T	T	T	T	T	T	T	T	
2	2	2.5	2	3	4	8	2.5	3.5	15	2.5	3.5	15	T	T	T	T	T	T	T	T	T	
5	5	6	5	10	13	30	6	16	45	6	16	45	45	T	T	T	T	45	T	T	T	
5	5	3.3	5	6	10	15	3.3	10	25	3.3	10	25	25	42	T	T	T	25	42	T	T	
4	4	3	4	5	7	12	3	8	18	3	8	18	18	30	45	T	T	18	30	45	T	
3	3	3	3	5	7	12	3	8	18	3	8	18	18	30	45	T	T	18	30	45	T	
2.5	2.5	3	2.5	5	7	10	3	8	18	3	8	18	18	30	45	T	T	18	30	45	T	
2.5	2.5	2.5	2.5	4	6	10	2.5	6.5	15	2.5	6.5	15	15	25	40	T	T	15	25	40	T	
2	2	2.5	2	4	6	10	2.5	6.5	15	2.5	6.5	15	15	25	40	T	T	15	25	40	T	



NZM

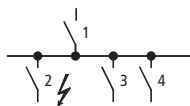

Incoming circuit-breaker
Outgoing circuit-breaker

Selectivity 415 V AC

between circuit-breakers enables separate shut-down of faulty system sections.
Selectivity (discrimination) exists between incoming breaker 1 and outgoing breaker 2 if, only outgoing breaker 2 trips at position 2 during a short-circuit.
System sections 3 and 4 continue to be operational.

Incoming circuit-breaker (S1)

NZM...1-A...

NZM...2-A...

I_{cu} [kA]		25(36)(50)(100)							25(36)(50)(150)										
I_n [A]		20-40	50	63	80	100	125	160	20-40	50	63	80	100	125	160	200	250	300	
Outgoing circuit-breaker (S2)	I_n [A]	Prospective short-circuit current (kA). Set the overload and short-circuit release of the incoming circuit-breaker to the max. value.																	
	$I_{cu(415V)}$ [kA]																		
NZM...1-A...	20-40	25-100	-	-	0.5	0.7	0.8	1.5	1.5	-	-	0.6	0.8	1.5	1.5	1.5	2	3	3
	50	25-100	-	-	-	0.6	0.8	1.5	1.5	-	-	-	0.8	1.5	1.5	1.5	2	3	3
	63	25-100	-	-	-	-	0.8	1.5	1.5	-	-	-	-	1.5	1.5	1.5	2	3	3
	80	25-100	-	-	-	-	-	1.5	1.5	-	-	-	-	-	1.5	1.5	2	3	3
	100	25-100	-	-	-	-	-	-	1.5	-	-	-	-	-	-	1.5	2	3	3
	125	25-100	-	-	-	-	-	-	-	-	-	-	-	-	-	-	2	3	3
160	25-100	-	-	-	-	-	-	-	-	-	-	-	-	-	-	2	3	3	
NZM...2-A...	20-40	25-150	-	-	0.5	0.6	0.8	1	1	-	-	0.5	0.6	0.8	1	1.2	1.6	2	2
	50	25-150	-	-	-	0.6	0.8	1	1	-	-	-	0.6	0.8	1	1.2	1.6	2	2
	63	25-150	-	-	-	-	0.8	1	1	-	-	-	-	0.8	1	1.2	1.6	2	2
	80	25-150	-	-	-	-	-	1	1	-	-	-	-	-	1	1.2	1.6	2	2
	100	25-150	-	-	-	-	-	-	1	-	-	-	-	-	-	1.2	1.6	2	2
	125	25-150	-	-	-	-	-	-	-	-	-	-	-	-	-	-	1.6	2	2
	160	25-150	-	-	-	-	-	-	-	-	-	-	-	-	-	-	-	2	2
	200	25-150	-	-	-	-	-	-	-	-	-	-	-	-	-	-	-	-	-
NZM...1-M...	40	25-150	-	-	-	-	0.8	1	1	-	-	-	-	0.8	1	1.2	1.6	2	2
	50	25-150	-	-	-	-	-	-	1	-	-	-	-	-	-	1.2	1.6	2	2
	63	25-150	-	-	-	-	-	-	1	-	-	-	-	-	-	1.2	1.6	2	2
	80	25-150	-	-	-	-	-	-	-	-	-	-	-	-	-	1.6	2	2	2
100	25-150	-	-	-	-	-	-	-	-	-	-	-	-	-	-	2	2	2	
NZM...2-M...	20-12	25-150	-	-	-	-	-	-	-	-	-	-	-	-	-	-	-	-	-
	160	25-150	-	-	-	-	-	-	-	-	-	-	-	-	-	-	-	-	-
	200	25-150	-	-	-	-	-	-	-	-	-	-	-	-	-	-	-	-	-
NZM...2-VE...	100	50-150	-	-	-	-	-	-	-	-	-	-	-	-	-	1.2	1.6	2	2
	160	50-150	-	-	-	-	-	-	-	-	-	-	-	-	-	-	-	-	-
	250	50-150	-	-	-	-	-	-	-	-	-	-	-	-	-	-	-	-	-
NZM...2-ME...	90	50-150	-	-	-	-	-	-	-	-	-	-	-	-	-	1.2	1.6	2	2
	140	50-150	-	-	-	-	-	-	-	-	-	-	-	-	-	-	-	-	-
	220	50-150	-	-	-	-	-	-	-	-	-	-	-	-	-	-	-	-	-
NZM...3-AE...	250	50-150	-	-	-	-	-	-	-	-	-	-	-	-	-	-	-	-	-
	320	50-150	-	-	-	-	-	-	-	-	-	-	-	-	-	-	-	-	-
	400	50-150	-	-	-	-	-	-	-	-	-	-	-	-	-	-	-	-	-
	500	50-150	-	-	-	-	-	-	-	-	-	-	-	-	-	-	-	-	-
	630	50-150	-	-	-	-	-	-	-	-	-	-	-	-	-	-	-	-	-
NZM...3-VE...	250	50-150	-	-	-	-	-	-	-	-	-	-	-	-	-	-	-	-	-
	400	50-150	-	-	-	-	-	-	-	-	-	-	-	-	-	-	-	-	-
	630	50-150	-	-	-	-	-	-	-	-	-	-	-	-	-	-	-	-	-
NZM...3-ME...	220	50-150	-	-	-	-	-	-	-	-	-	-	-	-	-	-	-	-	-
	350	50-150	-	-	-	-	-	-	-	-	-	-	-	-	-	-	-	-	-
	450	50-150	-	-	-	-	-	-	-	-	-	-	-	-	-	-	-	-	-
NZM...4-AE...	630	50-85	-	-	-	-	-	-	-	-	-	-	-	-	-	-	-	-	-
	800	50-85	-	-	-	-	-	-	-	-	-	-	-	-	-	-	-	-	-
	1000	50-85	-	-	-	-	-	-	-	-	-	-	-	-	-	-	-	-	-
	1250	50-85	-	-	-	-	-	-	-	-	-	-	-	-	-	-	-	-	-
	1600	50-85	-	-	-	-	-	-	-	-	-	-	-	-	-	-	-	-	-
NZM...4-VE...	630	50-85	-	-	-	-	-	-	-	-	-	-	-	-	-	-	-	-	-
	800	50-85	-	-	-	-	-	-	-	-	-	-	-	-	-	-	-	-	-
	1000	50-85	-	-	-	-	-	-	-	-	-	-	-	-	-	-	-	-	-
	1250	50-85	-	-	-	-	-	-	-	-	-	-	-	-	-	-	-	-	-
	1600	50-85	-	-	-	-	-	-	-	-	-	-	-	-	-	-	-	-	-
NZM...4-ME...	550	50-85	-	-	-	-	-	-	-	-	-	-	-	-	-	-	-	-	-
	875	50-85	-	-	-	-	-	-	-	-	-	-	-	-	-	-	-	-	-
	1400	50-85	-	-	-	-	-	-	-	-	-	-	-	-	-	-	-	-	-

Notes

T: total selectivity

Incoming circuit-breaker (S1)

NZM...2-VE...			NZM...3-A...				NZM...3-AE...			NZM...3-VE...			NZM...4-AE...					NZM...4-VE...														
50(150)			36(50)(150)				50(150)			50(150)			50(85)					50(85)														
100	160	250	250	320	400	500	250	400	630	250	400	630	630	800	1000	1250	1600	630	800	1000	1250	1600										
Prospective short-circuit current (kA). Set the overload and short-circuit release of the incoming circuit-breaker to the max. value.																																
2	5	7.5	3	4	6	7	7.5	20	20	12.5	25	25	T	T	T	T	T	T	T	T	T											
2	5	7.5	3	4	6	7	7.5	20	20	12.5	25	25	T	T	T	T	T	T	T	T	T											
2	5	6	3	4	6	7	6	15	15	11	20	20	T	T	T	T	T	T	T	T	T											
-	5	6	3	4	6	7	6	15	15	11	20	20	T	T	T	T	T	T	T	T	T											
-	5	6	3	4	6	7	6	15	15	11	20	20	T	T	T	T	T	T	T	T	T											
-	5	6	3	4	6	7	6	15	15	11	20	20	T	T	T	T	T	T	T	T	T											
-	5	6	3	4	6	7	6	15	15	11	20	20	T	T	T	T	T	T	T	T	T											
1	2	4	2.5	4	6	7	6	15	15	11	20	20	T	T	T	T	T	T	T	T	T											
1	2	4	2.5	4	6	7	6	15	15	11	20	20	T	T	T	T	T	T	T	T	T											
1	2	4	2.5	4	6	7	6	15	15	11	20	20	T	T	T	T	T	T	T	T	T											
-	2	4	2.5	4	6	7	6	15	15	11	20	20	T	T	T	T	T	T	T	T	T											
-	2	4	2.5	4	6	7	6	15	15	11	20	20	T	T	T	T	T	T	T	T	T											
-	-	4	2.5	4	6	7	6	15	15	11	20	20	T	T	T	T	T	T	T	T	T											
-	-	4	2.5	4	5	6	5	10	10	10	15	15	T	T	T	T	T	T	T	T	T											
-	-	-	-	-	5	6	-	10	10	-	15	15	T	T	T	T	T	T	T	T	T											
-	-	-	-	-	5	6	-	10	10	-	15	15	T	T	T	T	T	T	T	T	T											
-	-	-	-	-	5	6	-	10	10	-	15	15	T	T	T	T	T	T	T	T	T											
1	2	4	2.5	4	6	7	6	15	15	11	20	20	T	T	T	T	T	T	T	T	T											
-	2	4	2.5	4	6	7	6	15	15	11	20	20	T	T	T	T	T	T	T	T	T											
-	2	4	2.5	4	6	7	6	15	15	11	20	20	T	T	T	T	T	T	T	T	T											
-	2	4	2.5	4	6	7	6	15	15	11	20	20	T	T	T	T	T	T	T	T	T											
-	-	4	2.5	4	6	7	6	15	15	11	20	20	T	T	T	T	T	T	T	T	T											
-	-	2	2.5	4	6	7	6	7	10	7	10	12	T	T	T	T	T	T	T	T	T											
-	-	-	2.5	4	6	7	6	7	10	7	10	12	T	T	T	T	T	T	T	T	T											
-	-	-	-	-	6	7	-	7	10	-	10	12	T	T	T	T	T	T	T	T	T											
-	1.2	2	2.5	4	6	7	6	7	10	7	8	11	T	T	T	T	T	T	T	T	T											
-	-	2	2.5	4	6	7	6	7	10	7	8	11	T	T	T	T	T	T	T	T	T											
-	-	-	-	-	6	7	-	7	10	-	8	11	T	T	T	T	T	T	T	T	T											
-	-	2	2.5	4	6	7	6	7	10	5	10	12	T	T	T	T	T	T	T	T	T											
-	-	-	2.5	4	6	7	6	7	10	5	10	12	T	T	T	T	T	T	T	T	T											
-	-	-	-	-	6	7	-	7	10	5	10	12	T	T	T	T	T	T	T	T	T											
-	-	-	-	-	-	-	-	5	7.5	-	10	12	T/80	T/80	T/80	T/80	T/80	T/80	T/80	T/80	T/80											
-	-	-	-	-	-	-	-	5	7.5	-	10	12	T/80	T/80	T/80	T/80	T/80	T/80	T/80	T/80	T/80											
-	-	-	-	-	-	-	-	-	7.5	-	-	12	T/80	T/80	T/80	T/80	T/80	T/80	T/80	T/80	T/80											
-	-	-	-	-	-	-	-	-	-	-	-	-	-	T/80	T/80	T/80	T/80	T/80	T/80	T/80	T/80											
-	-	-	-	-	-	-	-	-	-	-	-	-	-	T/80	T/80	T/80	T/80	T/80	T/80	T/80	T/80											
-	-	-	-	-	-	-	-	3.5	4	-	10	12	T/80	T/80	T/80	T/80	T/80	T/80	T/80	T/80	T/80											
-	-	-	-	-	-	-	-	-	4	-	-	12	T/80	T/80	T/80	T/80	T/80	T/80	T/80	T/80	T/80											
-	-	-	-	-	-	-	-	-	-	-	-	-	-	T/80	T/80	T/80	T/80	T/80	T/80	T/80	T/80											
-	-	-	-	-	-	-	-	3.5	4	-	10	12	T/80	T/80	T/80	T/80	T/80	T/80	T/80	T/80	T/80											
-	-	-	-	-	-	-	-	-	4	-	-	12	T/80	T/80	T/80	T/80	T/80	T/80	T/80	T/80	T/80											
-	-	-	-	-	-	-	-	-	-	-	-	-	-	T/80	T/80	T/80	T/80	T/80	T/80	T/80	T/80											
-	-	-	-	-	-	-	-	-	-	-	-	-	-	T/80	T/80	T/80	T/80	T/80	T/80	T/80	T/80											
-	-	-	-	-	-	-	-	-	-	-	-	-	-	-	T/80	T/80	T/80	T/80	T/80	T/80	T/80											
-	-	-	-	-	-	-	-	-	-	-	-	-	-	-	10	15	20	20	-	10	15	20	20									
-	-	-	-	-	-	-	-	-	-	-	-	-	-	-	-	-	20	20	-	-	-	20	20									
-	-	-	-	-	-	-	-	-	-	-	-	-	-	-	-	-	-	20	20	-	-	-	20	20								
-	-	-	-	-	-	-	-	-	-	-	-	-	-	-	-	-	-	-	20	20	-	-	-	20	20							
-	-	-	-	-	-	-	-	-	-	-	-	-	-	-	-	-	-	-	-	20	20	-	-	-	20	20						
-	-	-	-	-	-	-	-	-	-	-	-	-	-	-	-	-	-	-	-	-	20	20	-	-	-	20	20					
-	-	-	-	-	-	-	-	-	-	-	-	-	-	-	-	-	-	-	-	-	-	20	20	-	-	-	20	20				
-	-	-	-	-	-	-	-	-	-	-	-	-	-	-	-	-	-	-	-	-	-	-	20	20	-	-	-	20	20			
-	-	-	-	-	-	-	-	-	-	-	-	-	-	-	-	-	-	-	-	-	-	-	-	20	20	-	-	-	20	20		
-	-	-	-	-	-	-	-	-	-	-	-	-	-	-	-	-	-	-	-	-	-	-	-	-	20	20	-	-	-	20	20	
-	-	-	-	-	-	-	-	-	-	-	-	-	-	-	-	-	-	-	-	-	-	-	-	-	-	20	20	-	-	-	20	20
-	-	-	-	-	-	-	-	-	-	-	-	-	-	-	-	-	-	-	-	-	-	-	-	-	-	-	-	-	-	-	-	-



Protection of PVC insulated cables against thermal overload due to short-circuits

According to VDE 0100 Part 430 Wiring Regulations, cables and conductors must be protected from overload and short-circuits. In circuit-breakers NZM, overload protection is implemented through the adjustable, current-dependently delayed overload release.

Short-circuit protection is provided by adjustable instantaneous releases, which open the main contacts in less than 25 ms. The short-circuit total opening time restricts the temperature rise of the cable to a minimum.

The tables indicate the minimum conductor cross-section reliably protected by circuit-breakers during a short-circuit.
(Operating voltage $U_N = 415$ V)

	Minimum protected cross-section mm ² copper
NZM...1(-4)-...20	6
NZM...1(-4)-...25 – 160	10
NZM...2(-4)-...20 – 300	10
NZM...3(-4)-...250 – 630	16
NZM...4(-4)-...630 – 1600	95

Backup protection

between incoming circuit-breaker NZM(N)(H) and outgoing circuit-breaker NZMB(N)(H)

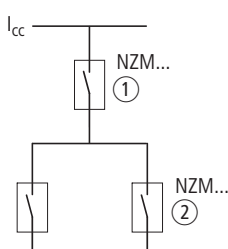

		Incoming circuit-breaker ①												
		NZM1 Up to 160 A				NZM2 Up to 250 A				NZM3 Up to 500 A			Up to 630 A	
		25 kA	36 kA	50 kA	100 kA	25 kA	36 kA	50 kA	150 kA	36 kA	50 kA	150 kA		
Outgoing circuit-breaker ②	$I_{cu}(415 V)$ I_n													
NZMB1 25 kA	Up to 160 A	25	36	50	100	25	36	50	100	36	50	100		
NZMC1 36 kA	Up to 160 A	–	36	50	100	–	36	50	100	36	50	100		
NZMN1 50 kA	Up to 160 A	–	–	50	100	–	–	50	100	–	50	100		
NZMH1 100 kA	Up to 160 A	–	–	–	100	–	–	–	100	–	–	100		
NZMB2 25 kA	Up to 300 A	25	36	50	100	25	36	50	150	36	50	150		
NZMC2 36 kA	Up to 300 A	–	36	50	100	–	36	50	150	36	50	150		
NZMN2 50 kA	Up to 300 A	–	–	50	100	–	–	50	150	–	50	150		
NZMH2 150 kA	Up to 300 A	–	–	–	–	–	–	–	150	–	–	150		
NZMC3 36 kA	Up to 500 A	–	–	–	–	–	–	–	–	–	50	150		
NZMN3 50 kA	Up to 630 A	–	–	–	–	–	–	–	–	–	50	150		
NZMH3 150 kA	Up to 630 A	–	–	–	–	–	–	–	–	–	–	150		

Where the prospective fault current at the mounting location of circuit-breakers is very high current-limiting circuit-breakers NZMN(H) are normally used. A cost-effective alternative if the fault level is too high for circuit-breakers NZMB(C)(N) is to fit a current-limiting circuit-breaker NZMN(H) upstream of an arrangement of standard circuit-breakers NZMB(C)(N).

The table shows which current-limiting circuit-breakers NZMN(H) provide reliable protection at network locations with high short-circuit ratings in combination with NZMB(C)(N).

The selectivity limit is determined by the response current of the non-delayed short-circuit release in the upstream incoming circuit-breaker. In many applications this is sufficient.

between incoming circuit-breaker NZM...1-A... and outgoing circuit-breaker FAZ-B(C)/PLSM-B(C)...

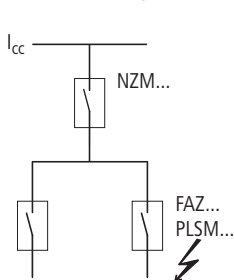

Outgoing circuit-breaker	Incoming circuit-breaker	
	NZMB1-A...	NZMC(N)(H)1-A...
FAZ-B(C)...	0.5 – 16	30 kA
	20 – 40	20 kA
	50, 63	15 kA
PLSM-B(C)...(/...)	0.5 – 16	30 kA
	20 – 40	20 kA
	50, 63	15 kA

between incoming circuit-breaker NZM...2-A... and outgoing circuit-breaker FAZ-B(C)/PLSM-B(C)...

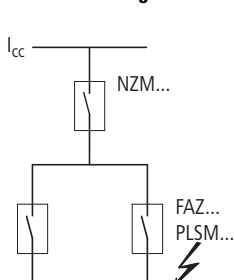

Outgoing circuit-breaker	Incoming circuit-breaker	
	NZMB2-A...	NZMN(H)2-A...
FAZ-B(C)...	0.5 – 10	50 kA
	13 – 32	30 kA
	40 – 63	20 kA
PLSM-B(C)...(/...)	0.5 – 10	50 kA
	13 – 32	30 kA
	40 – 63	20 kA

Direction of blow-out

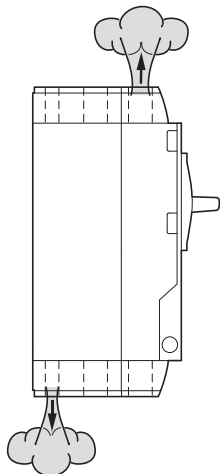

	Top, front	Bottom, rear
NZM1	X	—
NZMB(C)2-A... 250	X	—
(P)N2(-4)-...	X	—
NZMN(H)2...	X	X
NZM...2-4..	X	X
NZM3	X	X
NZM4	X	—

Minimum clearances

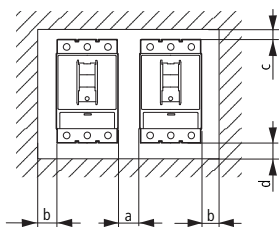

between two adjacently mounted switches
Minimum clearance a in mm

	NZM1	NZM2	NZM3	NZM4
NZM1	0	5	5	15
NZM2	5	5	5	15
NZM3	5	5	5	15
NZM4	15	15	15	15

between switches and other parts
Minimum clearances in mm

	b		c			d	
	≤ 690 V	1000 V	≤ 440 V	≤ 690 V	1000 V	≤ 690 V	1000 V
NZM1	0	—	30	60	—	0	—
NZM2 ¹⁾	5	5	20 ¹⁾	35 ¹⁾	35	35	35
NZM3	5	5	30	60	60	60	60
NZM4	15	15	50	100 ²⁾	200	0	0

¹⁾ NZMB(C)2 – A ... ≤ 440 V: C = 20 mm, d = 0 mm
≤ 690 V: C = 60 mm, d = 0 mm

²⁾ At 690 V IT network: 200 mm

Tube cable lugs, dimensions

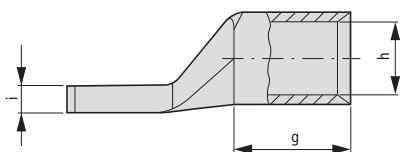

For pressing the cable lugs a press tool K22, HK60/22 or EK22 from Klauke with the following press inserts is required:

- R22/95 for 95 mm²
- R22/120 for 120 mm²
- R22/150 for 150 mm²
- R22/185 for 185 mm²
- R22/240 for 240 mm²

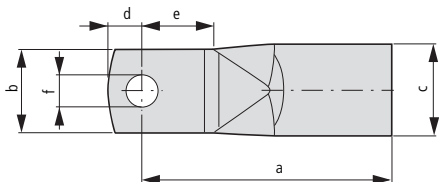

Cable lug	For use with	Nominal cross section mm ²	Terminal bolt Ø	Dimensions in mm								
				a	b	c	d	e	f	g	h	i
KS95-NZM7	NZM2	95	M8	53 ⁺²	23 ^{±0.5}	18 ^{±0.2}	10 ^{±1}	19	8.5	25	13.5	4.4
KS120-NZM7	NZM2	120	M8	56 ⁺²	23 ^{±0.5}	19.5 ^{±0.2}	10 ^{±1}	19	8.5	26	15	4.4
KS150-NZM7	NZM2	150	M8	61 ⁺²	23 ^{±0.5}	21 ^{±0.2}	10 ^{±1}	19	8.5	30	16.5	4.4
NZM2-XKS185	NZM2	185	M8	65 ^{±1.5}	22 ^{±1}	24 ^{±0.3}	9 ⁺¹ _{-0.5}	19 ^{+2.5} _{-0.5}	8.5 ^{+0.05} _{-0.1}	30 ^{±2}	19 ^{±0.4}	7
NZM3-XKS185	NZM3, NZM4	185	M10	65	24.5	24	11.5	18	10.5	30	19	7.0 ^{±0.8}
NZM3-XKS240	NZM3, NZM4	240	M10	72	31	26	11.5	19	10.5	35	21	5.0 ^{±0.8}



Engineering

Front cut-outs

Cut-out a
Rocker lever

Cut-out b
Rotary handle, remote operator

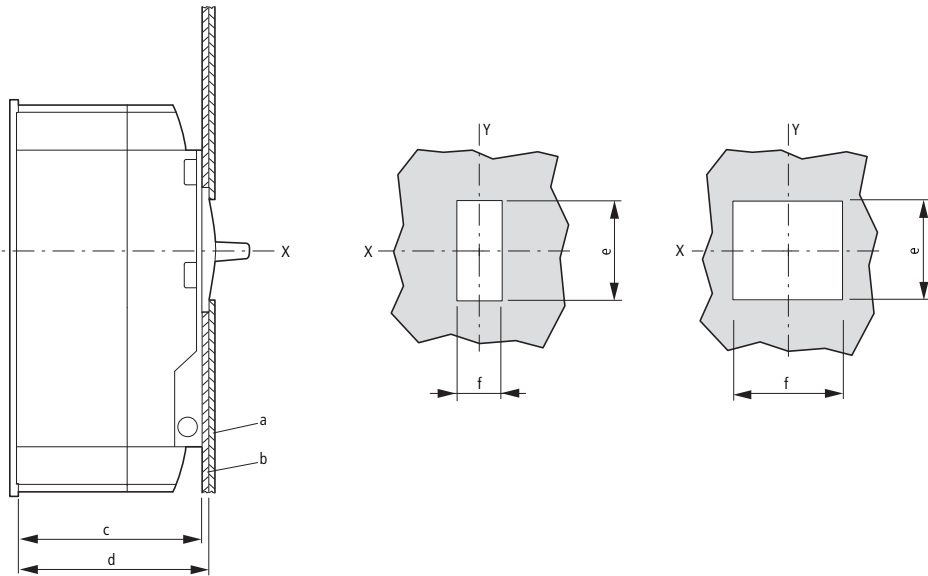

	Distance from mounting plate and door cut-out		Cut-out a		Cut-out b	
	c	d	e	f	e	f
	mm	mm	mm	mm	mm	mm
NZM1	68	73	40	23	46	91
NZM2	103	108	79	36	96	101
NZM3	120.5	125.5	79	36	96	136
NZM4	138	146	101	105	118	204

Contact sequence of the auxiliary contacts

Standard auxiliary contacts (HIN)

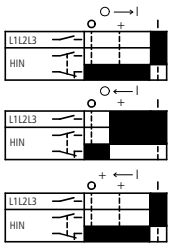

Early-make auxiliary contact (HIV)

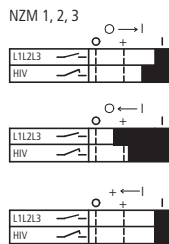

Trip-indicating auxiliary contacts (HIA)

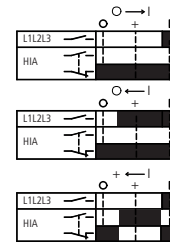

0 → I Switch-on

0 ← I Switch-off

+ ← I Trip

■ Contact closed

□ Contact opened

Notes

If early-make contacts are required in combination with shunt or undervoltage releases, please select the combination type in section "Releases"

Interlock variations and combination possibilities

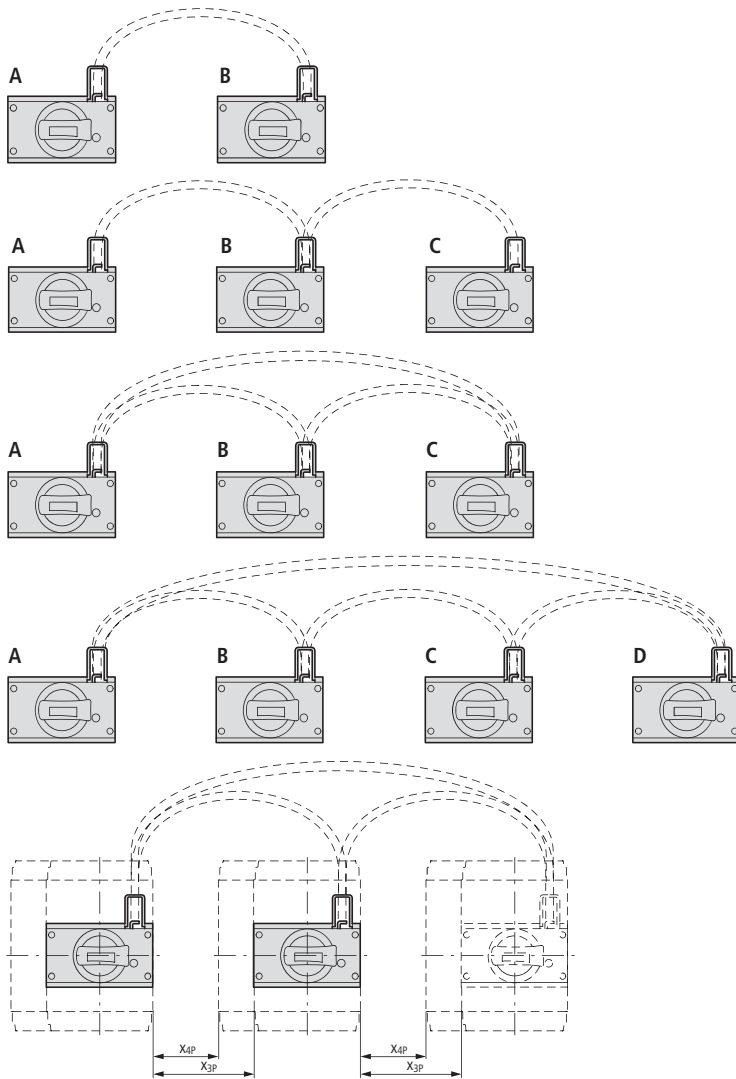

A	B
OFF	OFF
ON/TRIP	ON
ON	ON/TRIP

A	B	C
OFF	OFF	OFF
ON	ON/TRIP	ON
ON/TRIP	ON	ON/TRIP

A	B	C
OFF	OFF	OFF
ON/TRIP	ON	ON
ON	ON/TRIP	ON
ON	ON	ON/TRIP

A	B	C	D
OFF	OFF	OFF	OFF
ON/TRIP	ON	ON/TRIP	ON
ON	ON/TRIP	ON	ON/TRIP

X_{3p} = switch spacing, 3 pole
 X_{4p} = switch spacing, 4 pole

NZM-				Right switch					
Max. switch spacing		NZM1		NZM2		NZM3		NZM4	
Left switch		X_{3P}	X_{4P}	X_{3P}	X_{4P}	X_{3P}	X_{4P}	X_{3P}	X_{4P}
		mm	mm	mm	mm	mm	mm	mm	mm
NZM1	3/4 pole	135	105	120	85	135	90	125	80
NZM2	3/4 pole	135	105	120	85	135	90	125	80
NZM3	3/4 pole	90	75	75	35	85	40	80	45
NZM4	3/4 pole	50	35	40	15	25	-	15	-

NZM-XBZ600				Right switch					
Max. switch spacing		NZM1		NZM2		NZM3		NZM4	
Left switch		X_{3P}	X_{4P}	X_{3P}	X_{4P}	X_{3P}	X_{4P}	X_{3P}	X_{4P}
		mm	mm	mm	mm	mm	mm	mm	mm
NZM1	3/4 pole	510	480	495	460	510	465	475	405
NZM2	3/4 pole	510	480	495	460	510	465	475	405
NZM3	3/4 pole	460	430	450	410	460	415	460	390
NZM4	3/4 pole	400	370	380	340	400	375	390	320

NZM-XBZ1000				Right switch					
Max. switch spacing		NZM1		NZM2		NZM3		NZM4	
Left switch		X_{3P}	X_{4P}	X_{3P}	X_{4P}	X_{3P}	X_{4P}	X_{3P}	X_{4P}
		mm	mm	mm	mm	mm	mm	mm	mm
NZM1	3/4 pole	910	880	895	860	910	865	865	795
NZM2	3/4 pole	910	880	895	860	910	865	865	795
NZM3	3/4 pole	820	790	850	810	860	815	860	790
NZM4	3/4 pole	750	720	730	700	800	775	790	720



17/152 Circuit-breakers, switch-disconnectors

Mechanical interlock for remote operator, residual-current relay

NZM...-XMVR(L)

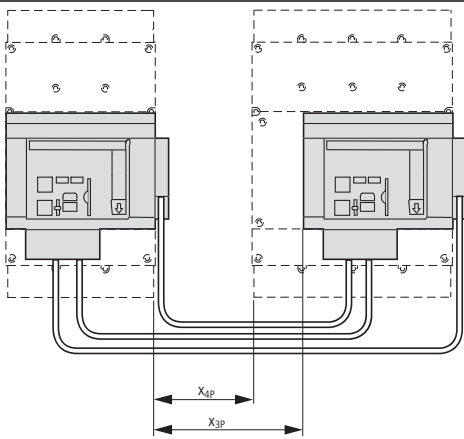

X_{3p} = max. switch spacing 3 pole

X_{4p} = max. switch spacing 4 pole

Mechanical interlock XMVR

NZM...-XMVR (mounted side-by-side)

Max. switch spacing		Right switch					
		NZM2		NZM3		NZM4	
		X_{3p}	X_{4p}	X_{3p}	X_{4p}	X_{3p}	X_{4p}
Left switch		mm	mm	mm	mm	mm	mm
NZM2	3/4 pole	130	95	95	50	–	–
NZM3	3/4 pole	–	–	135	90	155	85
NZM4	3/4 pole	–	–	–	–	120	50

Mechanical interlock XMVRL

NZM...-XMVRL (mounted side-by-side, in adjacent enclosures)

Max. switch spacing		Right switch					
		NZM2		NZM3		NZM4	
		X_{3p}	X_{4p}	X_{3p}	X_{4p}	X_{3p}	X_{4p}
Left switch		mm	mm	mm	mm	mm	mm
NZM2	3/4 pole	350	315	420	385	–	–
NZM3	3/4 pole	–	–	400	365	460	390
NZM4	3/4 pole	–	–	–	–	420	350

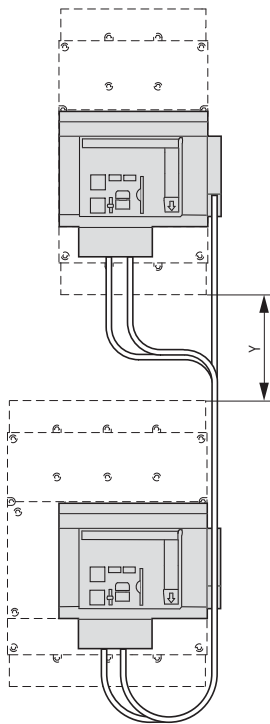

Mechanical interlock XMVRL

NZM...-XMVRL (mounted one above the other)

Max. switch spacing		Switch at top		
		NZM2 3/4 pole	NZM3 3/4 pole	NZM4 3/4 pole
		Y	Y	Y
Switch at bottom		mm	mm	mm
NZM2	3/4 pole	220	225	–
NZM3	3/4 pole	–	220	230
NZM4	3/4 pole	–	–	230

Y = max. switch spacing

Residual-current relay PFR

Ring-type transformer PFR-W...

Maximum rated operational current [A]		Diameter	
Power distribution	Motor/capacitor	Transformer part no. PFR-W-... d1	Maximum conductor circumference (mm) d2
50	50	20	13
150	100	30	20
150	100	35	23
400	200	70	47
600	250	105	70
1200	630	140	93
1800	800	210	140

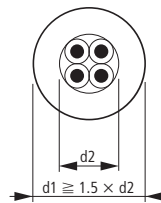

Additional terminal arrangement for side wall operator with mounting bracket.

NZM1-XS(R)M-..., NZM2-XS(R)M-...
 Additional terminals K25, K50, K95, K150
 Actuation:

3 pole

For operation on the right

For operation on the left

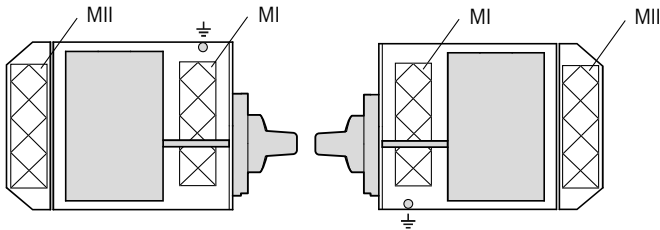

4 pole

For operation on the right

For operation on the left

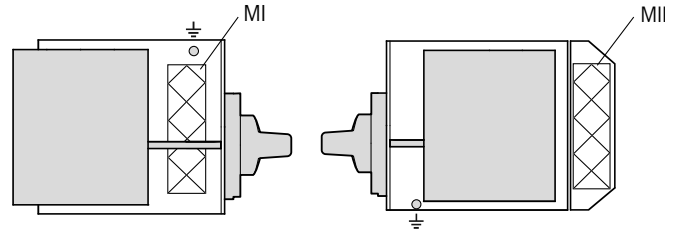

Mounting areas	MI				MII	
	V1	V2	V3	V4	V1	V2
Variation options						
Maximum number of additional terminals	K25	2 x	-	-	-	-
	K50	-	2 x	-	-	-
	K95	-	-	1 x	-	1 x
	K150	-	-	-	1 x	1 x

Example: In mounting area MI, variation option 1 allows the K25 additional terminal to be mounted twice.

2/3-wire control remote operator

Please note for engineering:

Three-wire control

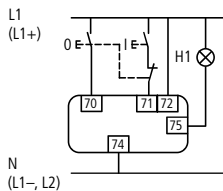

Terminal 70/71:

NZM-XR: Contact loading according to technical data

NZM2-XRD: Full current flows through the contact during make and break!

RMQ series contact elements can be used for the remote operators. NZM2(3.4)-XR(D)...

Two-wire control

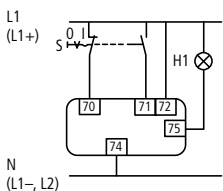

Terminal 75:

NZM-XR: Operational readiness signal when cover closed and not locked.

NZM2-XRD: Operational readiness signal when sliding switch set to Auto.

Sliding switch with three positions: Manual/Auto/Locked for reliable differentiation of operating positions.

AC-15: 400 V; 2 A

DC-13: 220 V; 0.2 A

Three-wire control with automatic reset to the 0 position after the switch has tripped

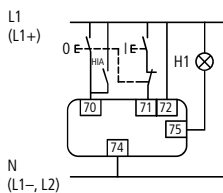

Switching cycle:

NZM2-XRD



NZM2-XR



NZM3-XR



NZM4-XR



The time interval between OFF and ON is 3 seconds.

ON commands received during the time interval are ignored within the first 3 seconds after switch off.



17/154 Circuit-breakers, switch-disconnectors

Construction size 1, 2: tripping characteristics

NZM1, NZM2

System and line protection with NZM1

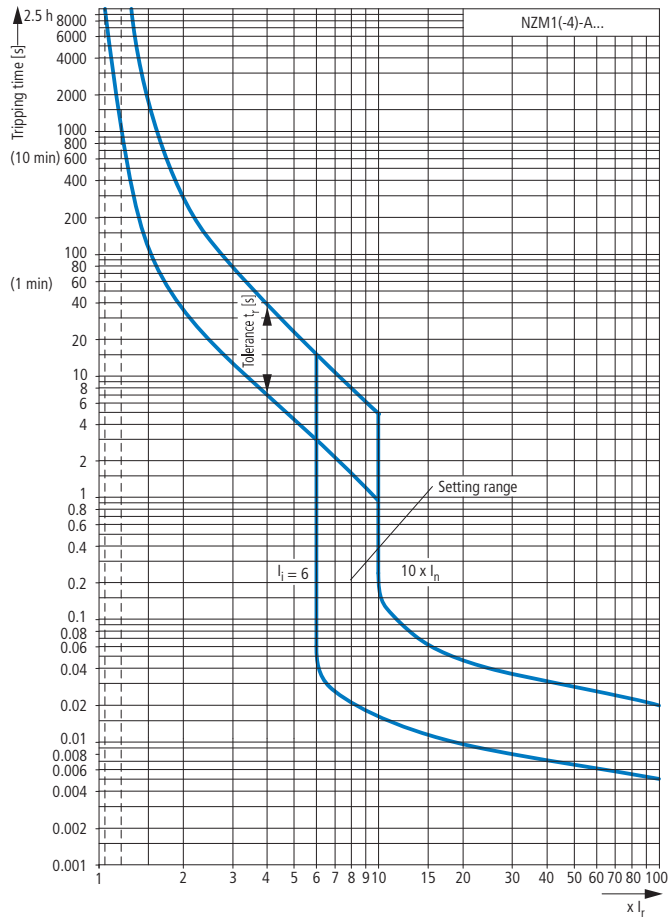

Motor protection with NZM1

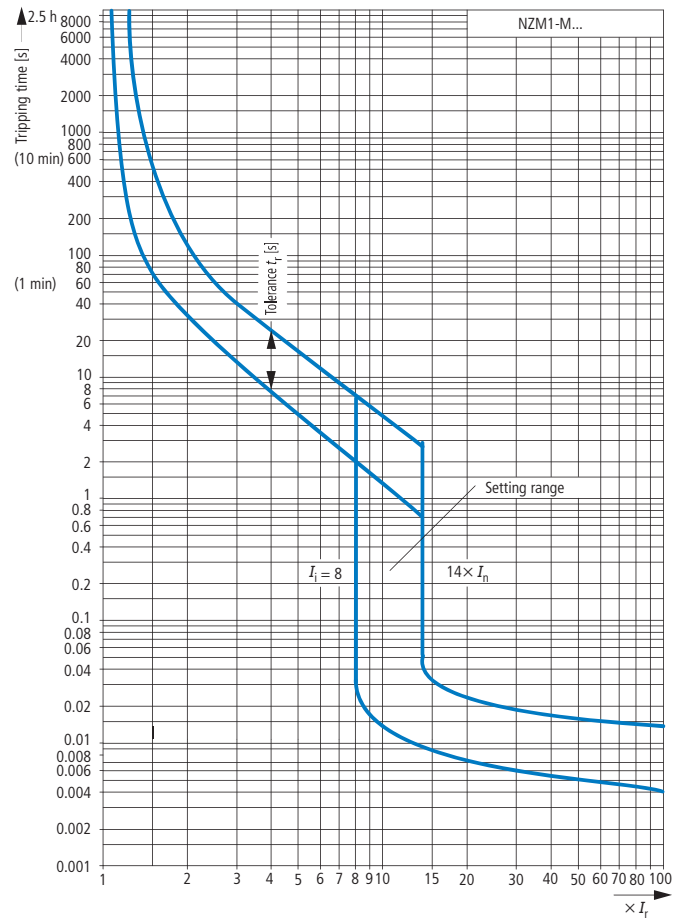

System and line protection with NZM2

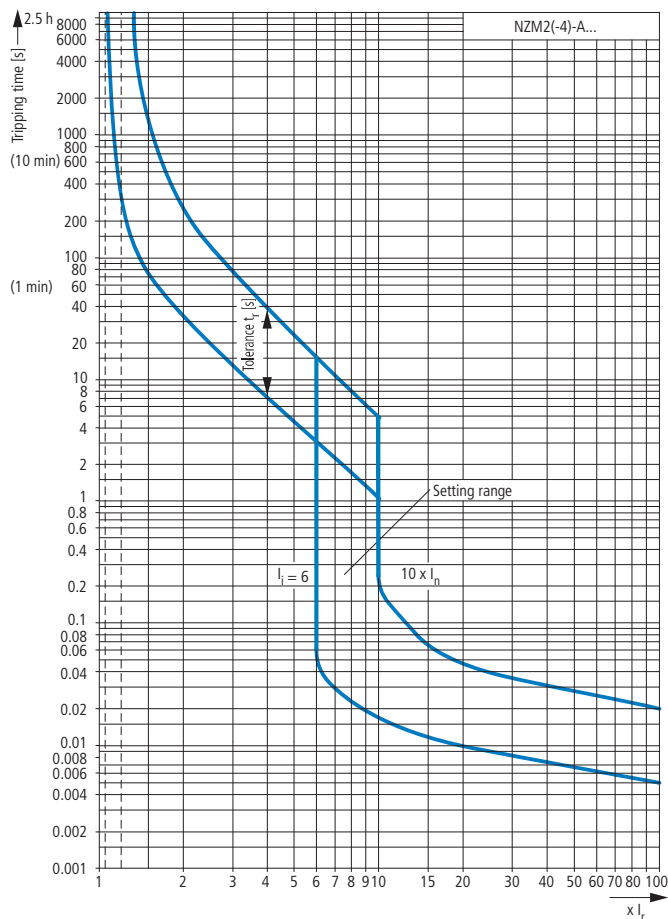

Motor protection with NZM2

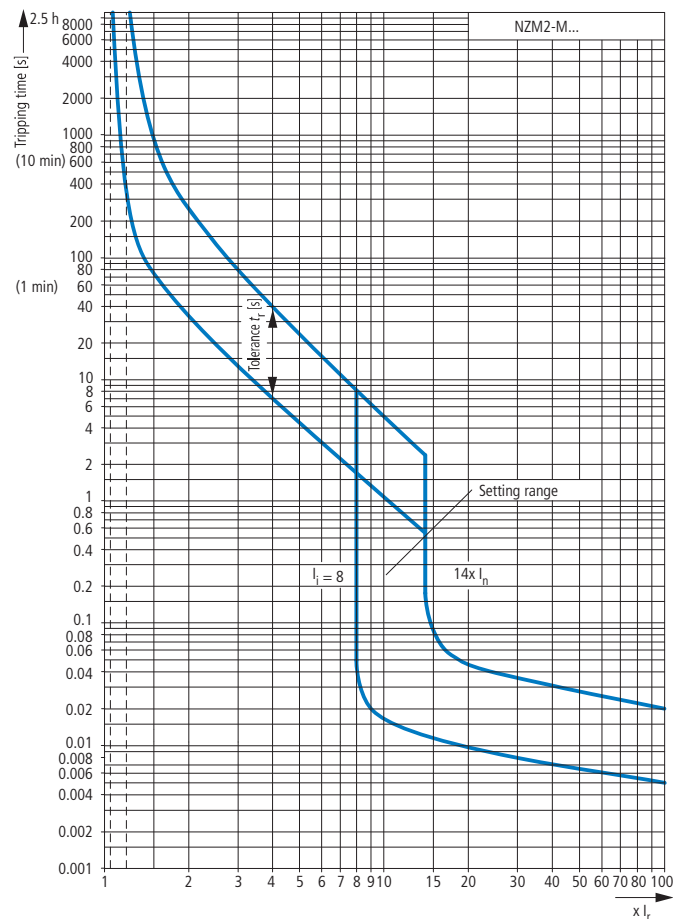

Notes

With the free CurveSelect software you can quickly and easily create detailed representations of individual settings:

www.moeller.net, Products & Solutions > Power Distribution > Switching and Protecting Power Distribution > CurveSelect: Characteristics program

Systems, cable, selectivity and generator protection with NZM2

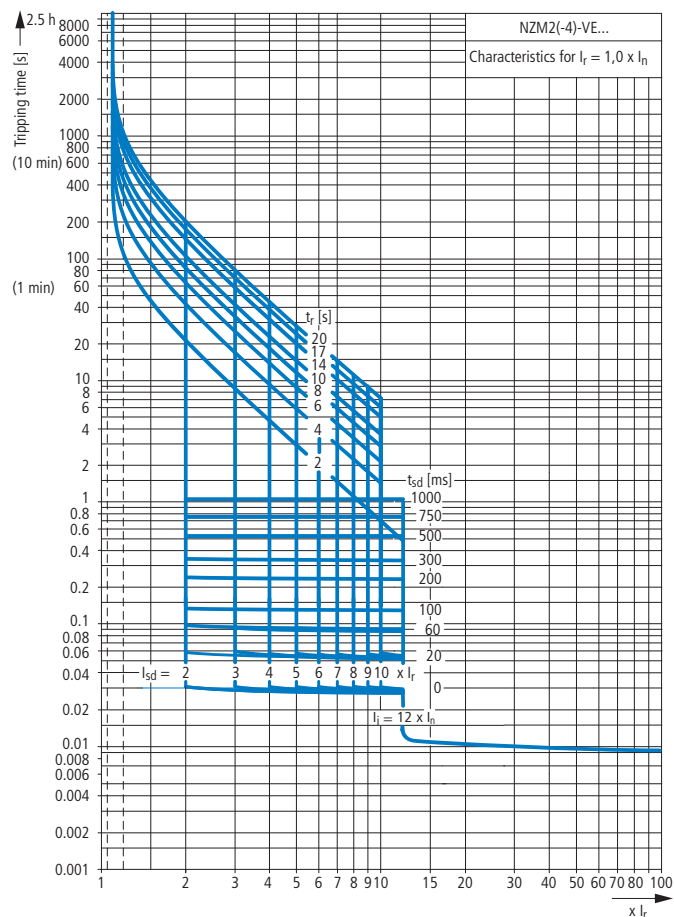

Motor protection with NZM2

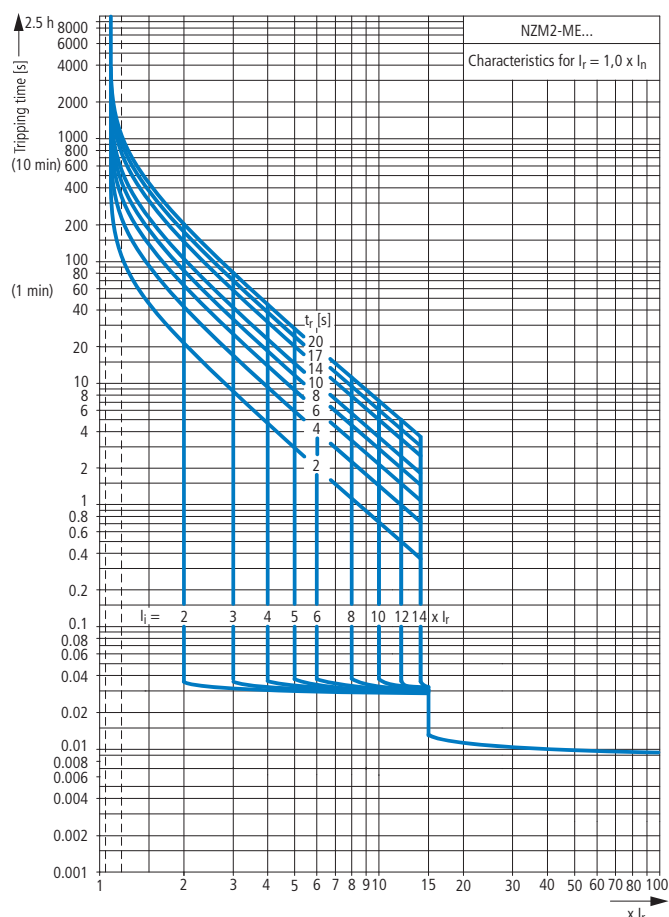

System and line protection with NZM3

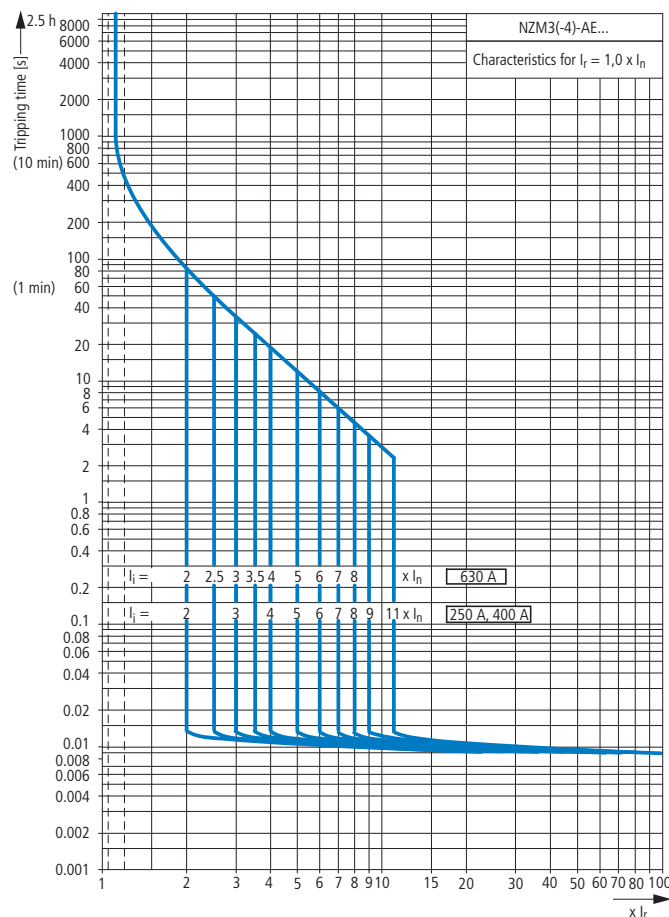
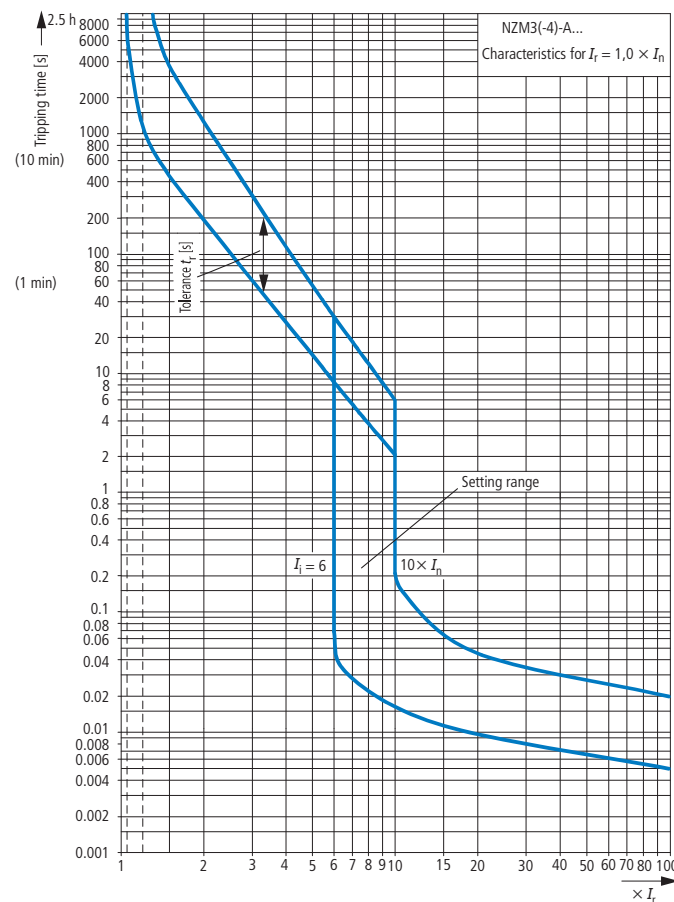

Notes

With the free CurveSelect software you can quickly and easily create detailed representations of individual settings:

www.moeller.net, Products & Solutions > Power Distribution > Switching and Protecting Power Distribution > CurveSelect: Characteristics program



Systems, cable, selectivity and generator protection with NZM3

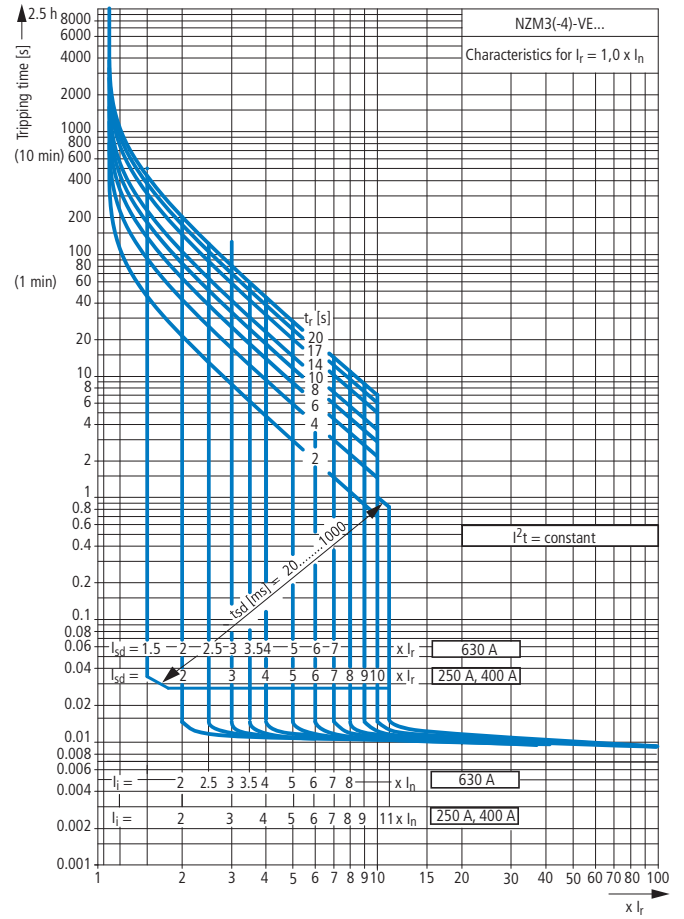
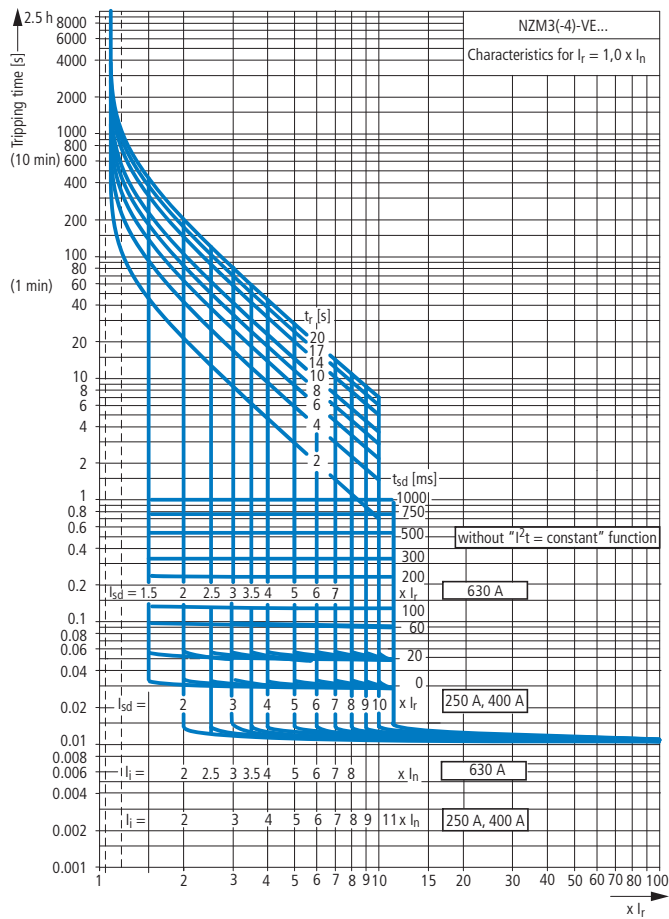

Motor protection with NZM3

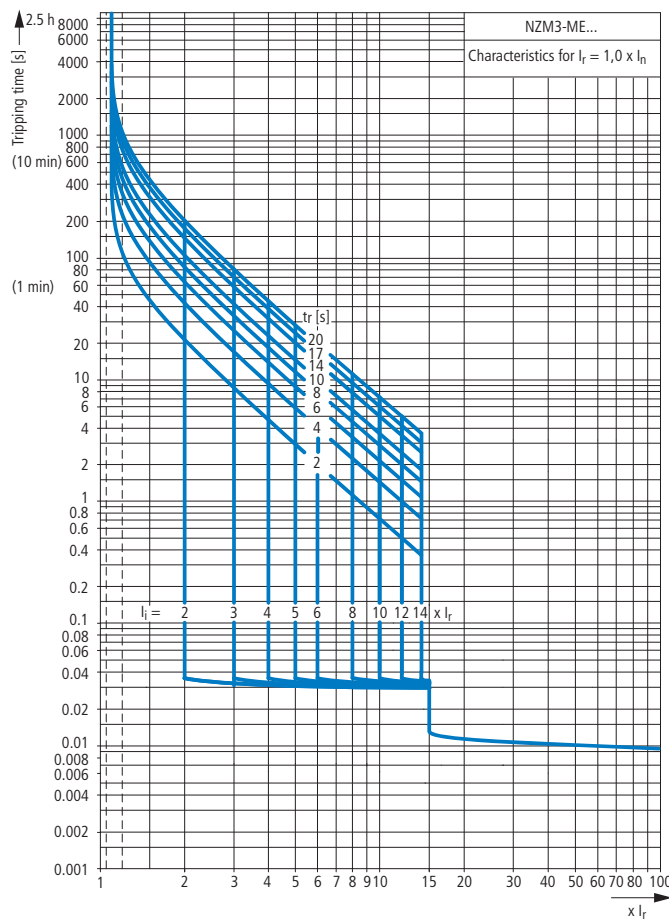

Notes

With the free CurveSelect software you can quickly and easily create detailed representations of individual settings:

www.moeller.net, Products & Solutions > Power Distribution > Switching and Protecting Power Distribution > CurveSelect: Characteristics program

System and line protection with NZM4

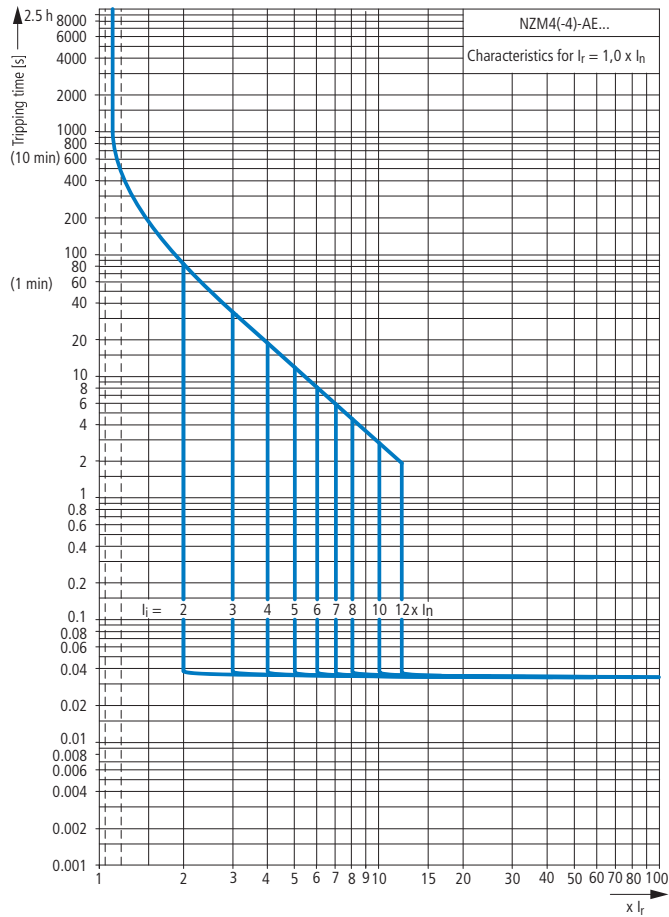

Systems, cable, selectivity and generator protection with NZM4

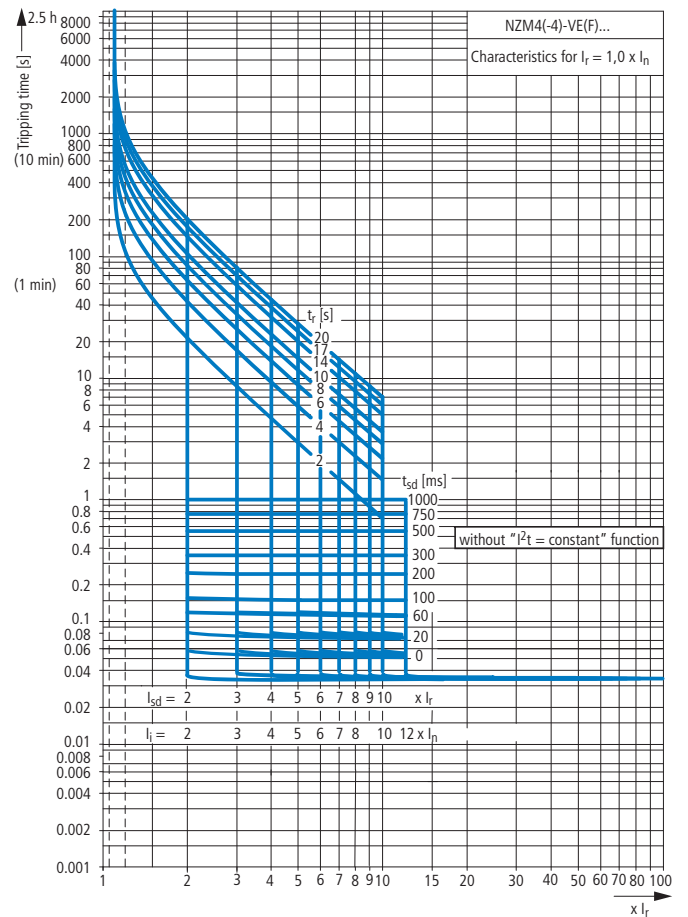

Systems, cable, selectivity and generator protection with NZM4

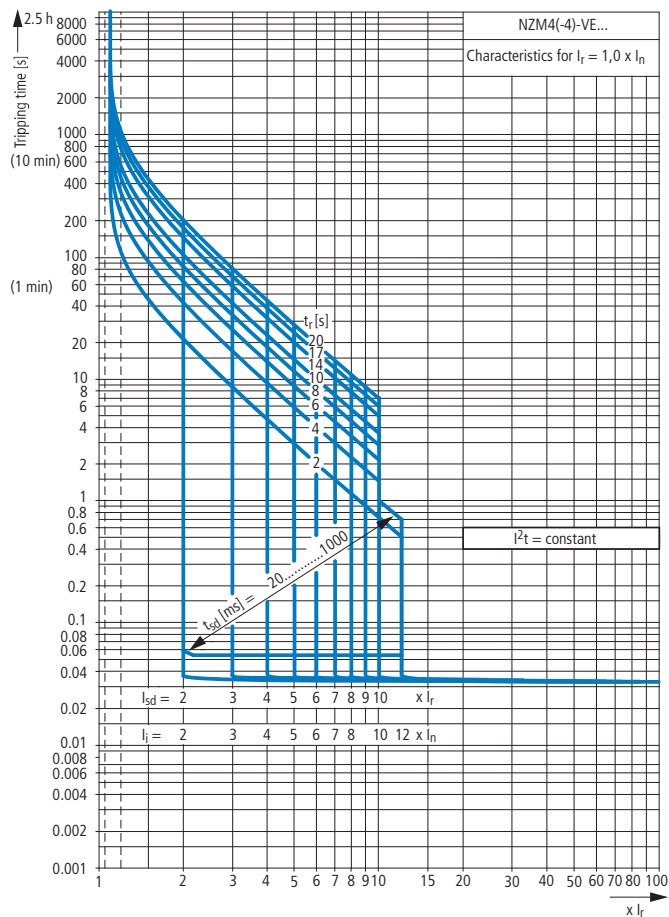

Motor protection with NZM4

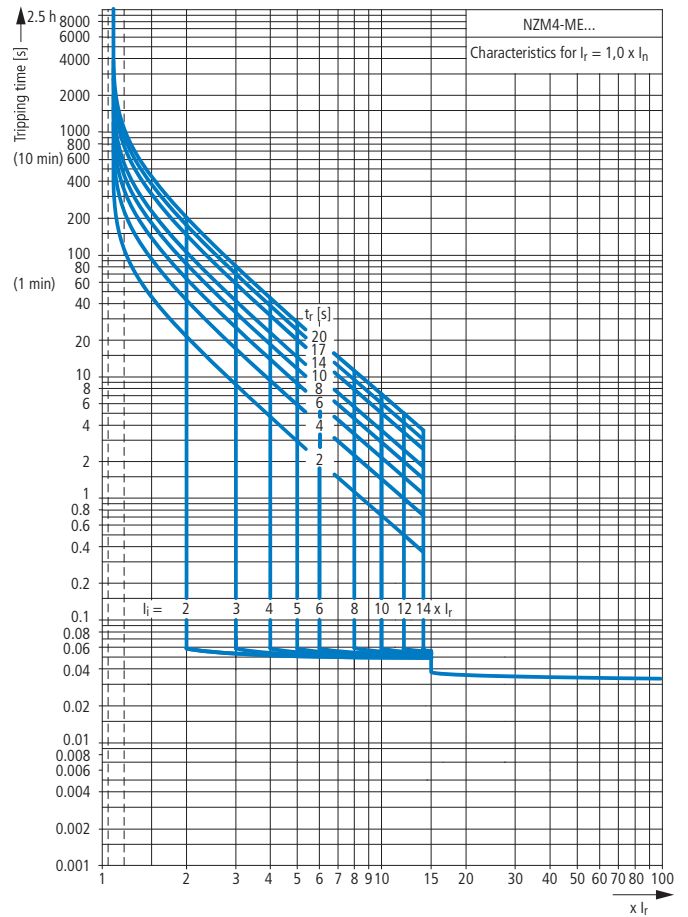

Notes

With the free CurveSelect software you can quickly and easily create detailed representations of individual settings:

www.moeller.net, Products & Solutions > Power Distribution > Switching and Protecting Power Distribution > CurveSelect: Characteristics program



NZM1

Let-through current I_D

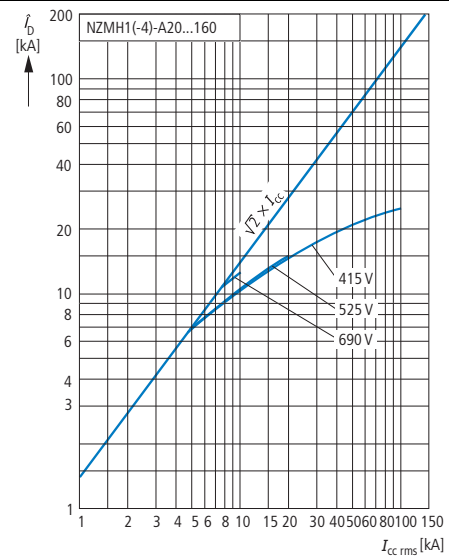
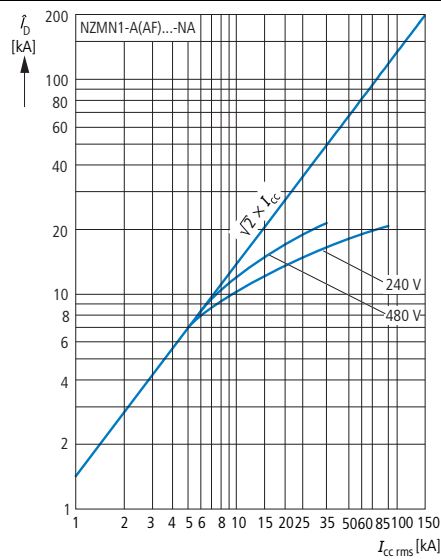
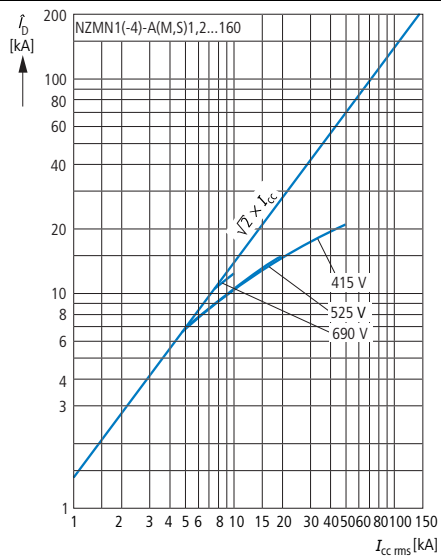
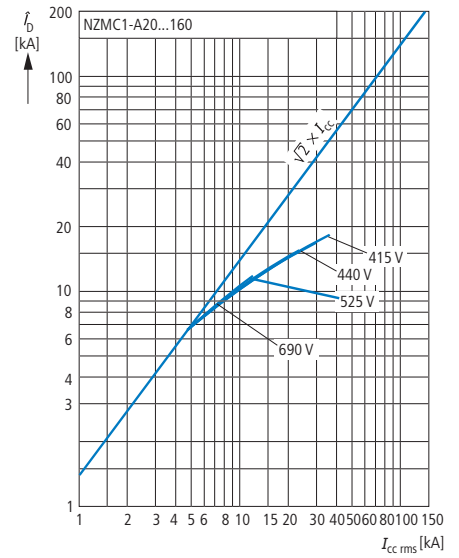
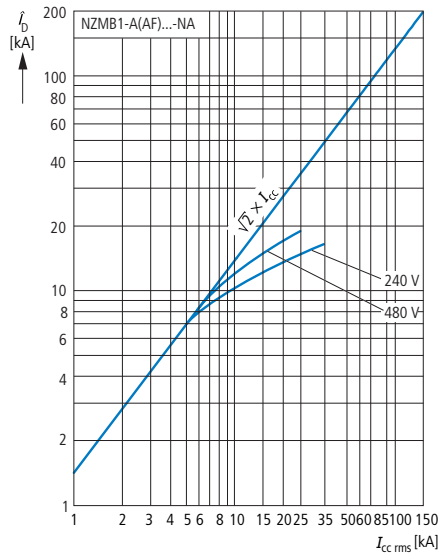
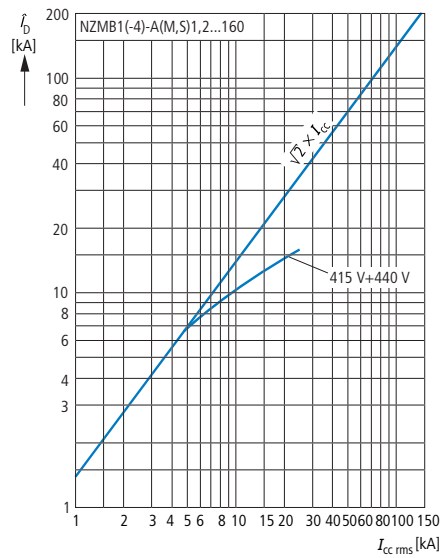

Let-through current \hat{I}_D

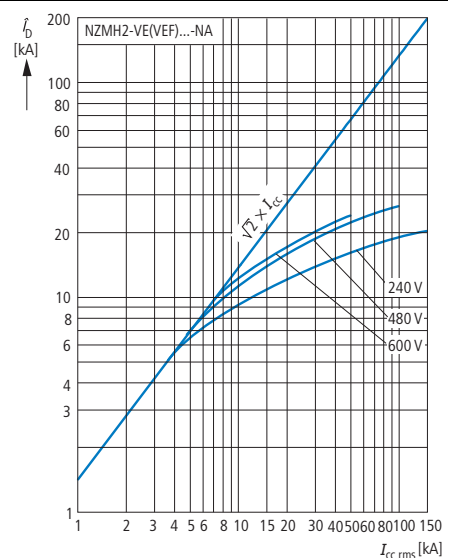
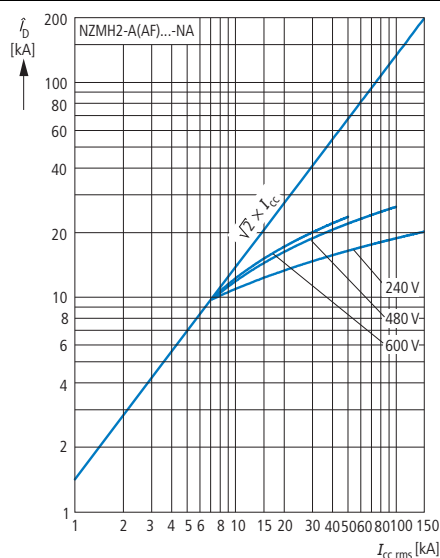
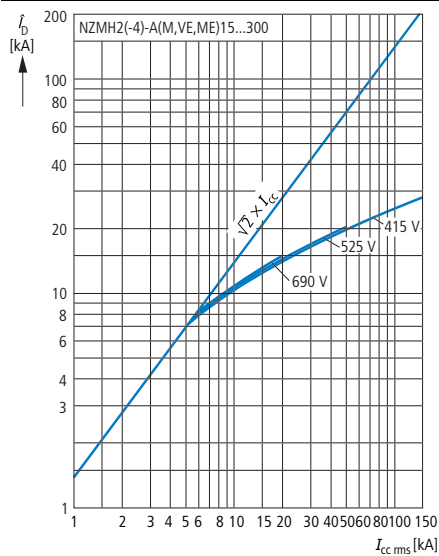
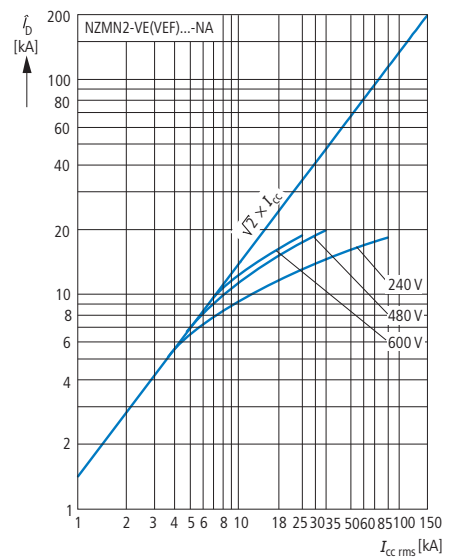
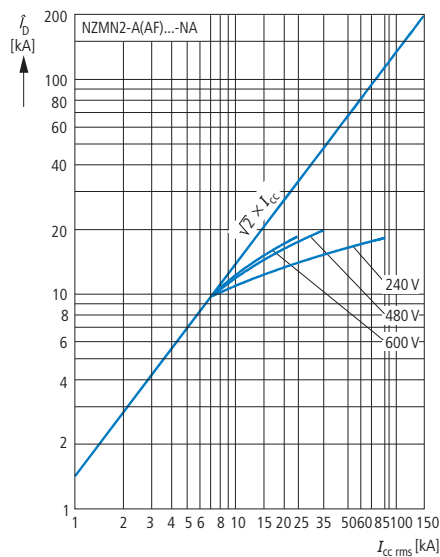
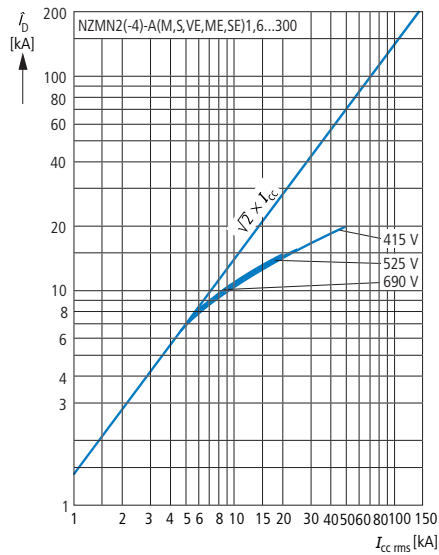
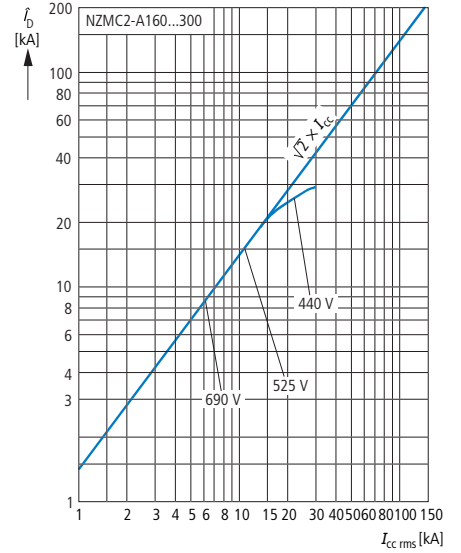
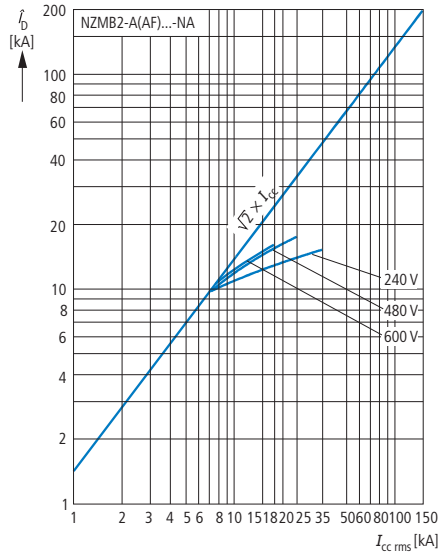
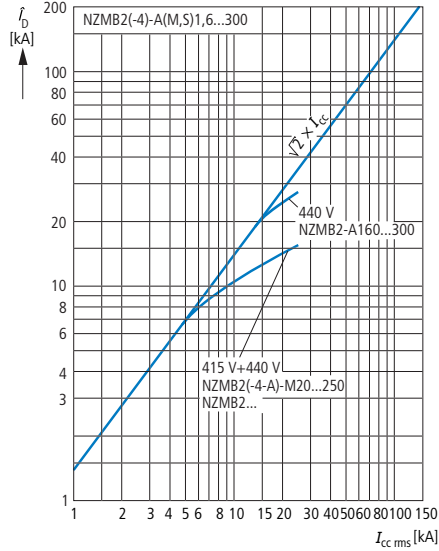

17/160 Circuit-breakers, switch-disconnectors

Construction size 3: let-through characteristics

NZM3

Let-through current \dot{I}_D

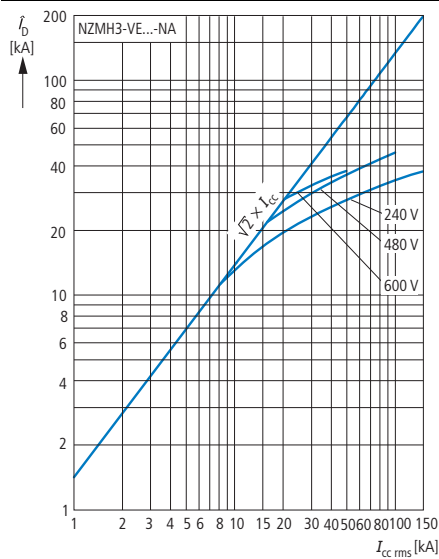
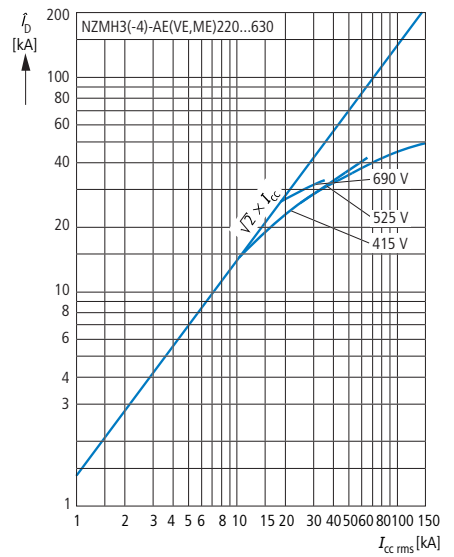
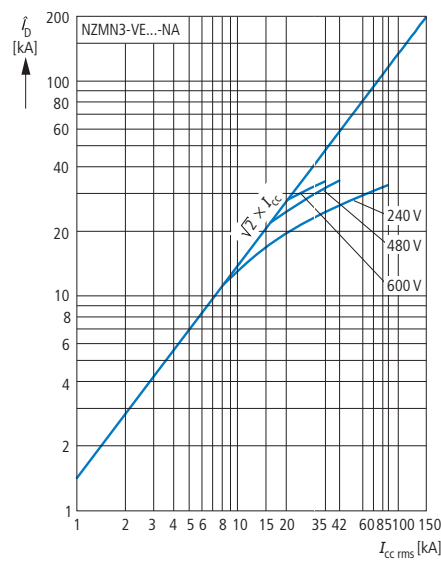
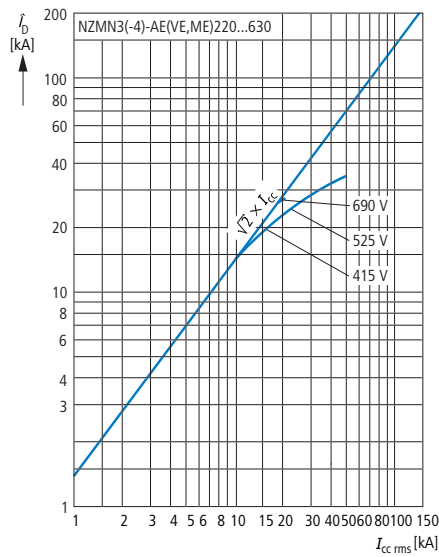
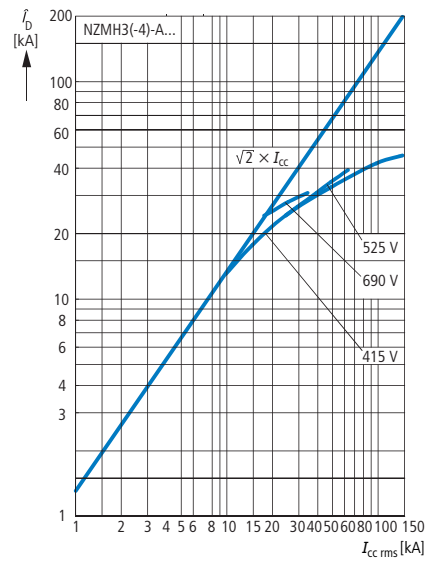
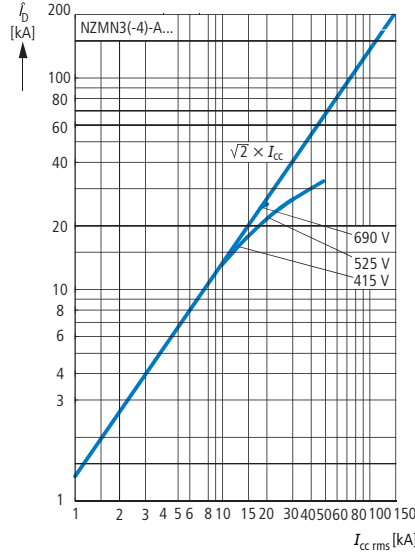
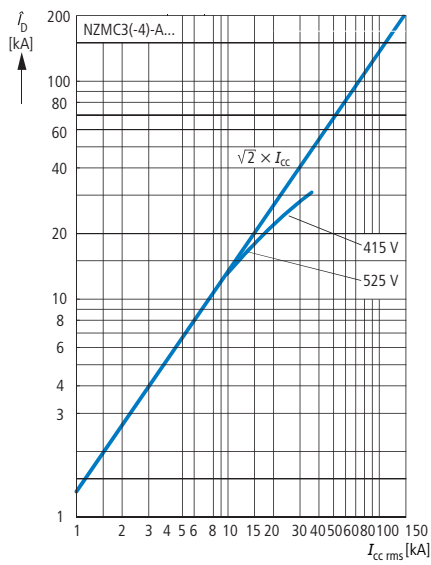

Let-through energy $\int i^2 dt$

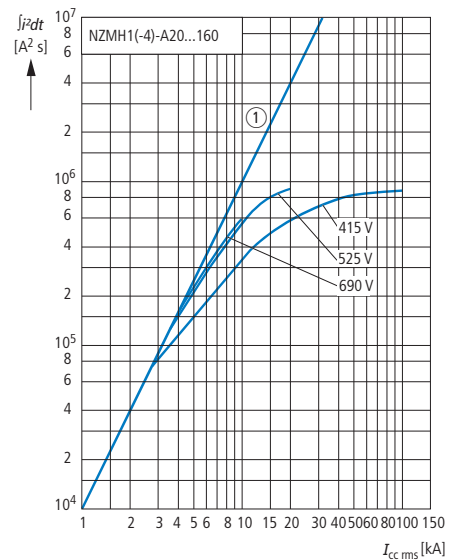
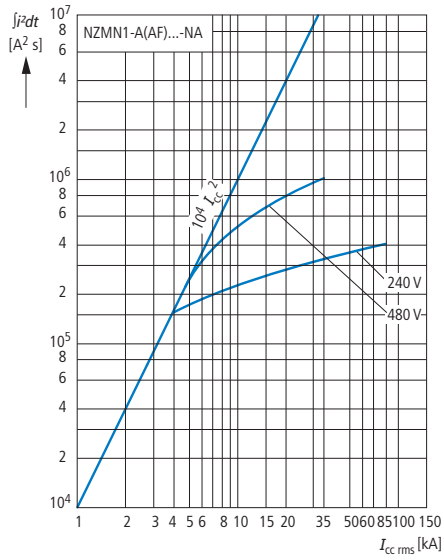
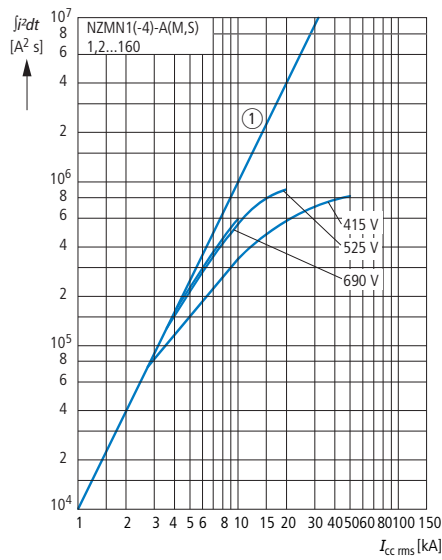
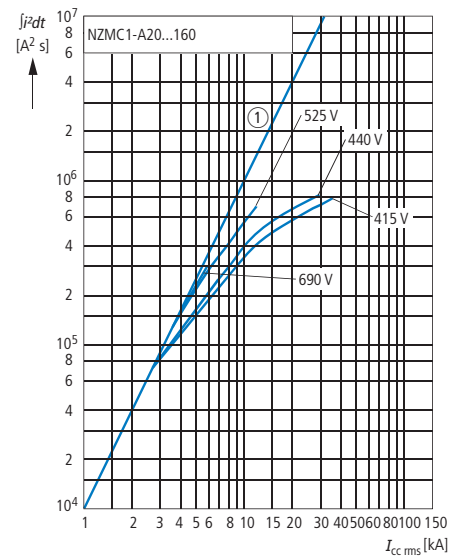
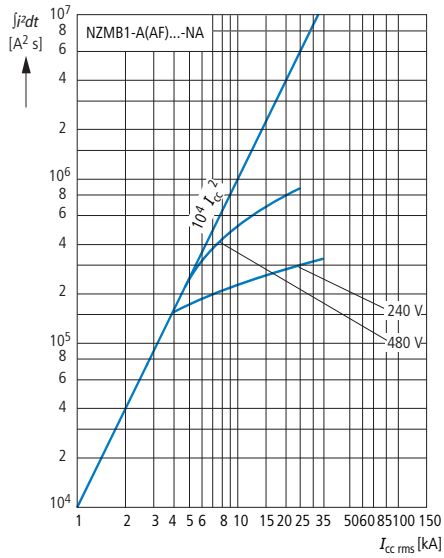
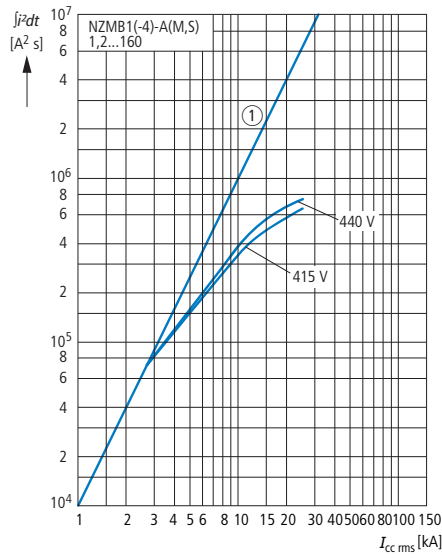

① 1 half-cycle

① 1 half-cycle



17/162 Circuit-breakers, switch-disconnectors

Construction size 2: let-through characteristics

NZM2

Let-through energy I^2t

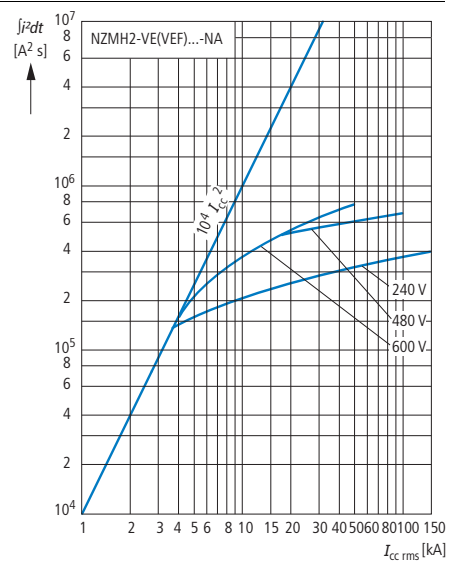
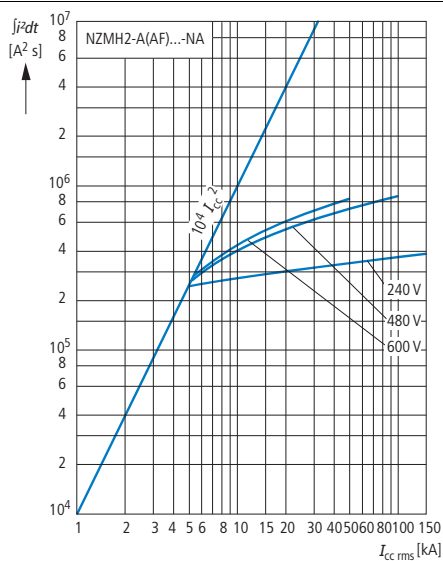
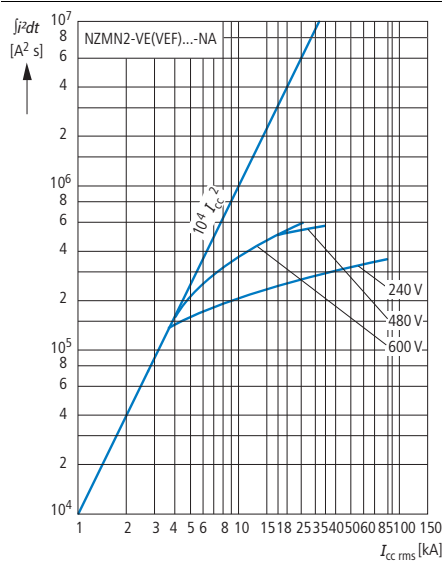
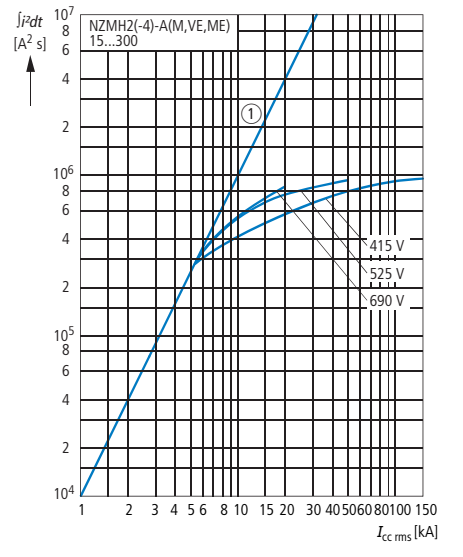
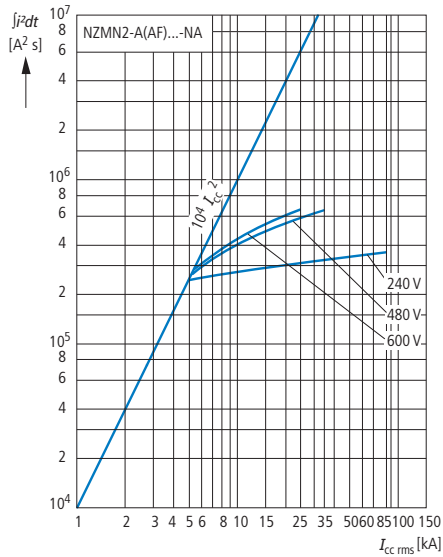
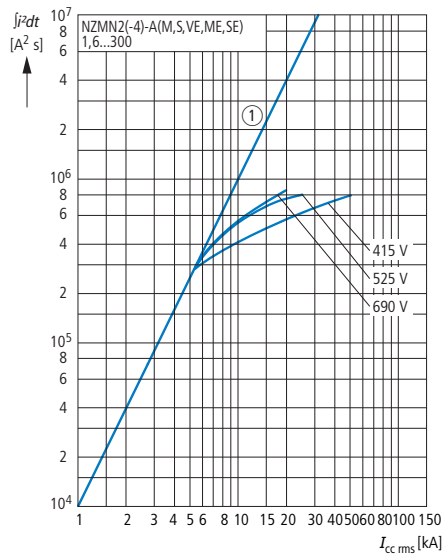
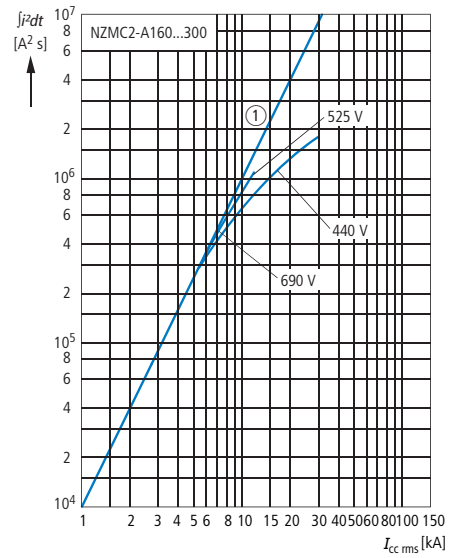
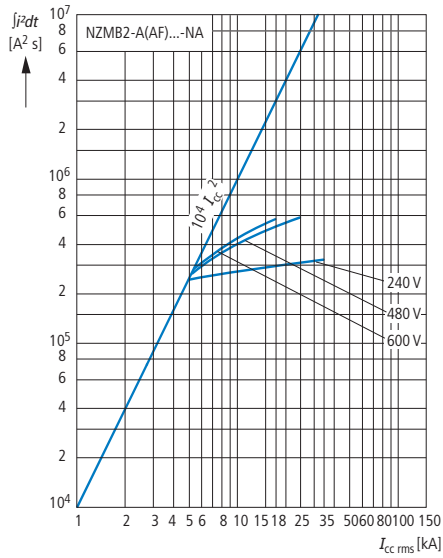
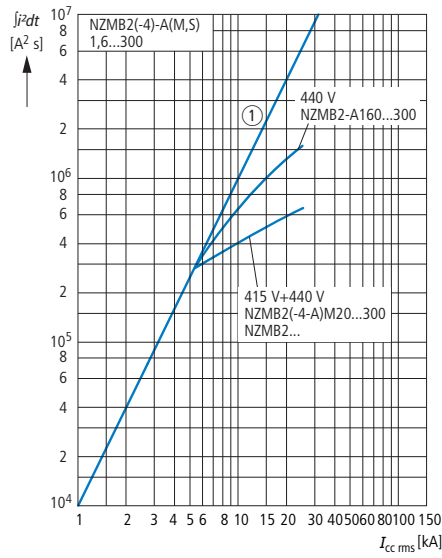

① 1 half-cycle

① 1 half-cycle

Let-through energy I^2t

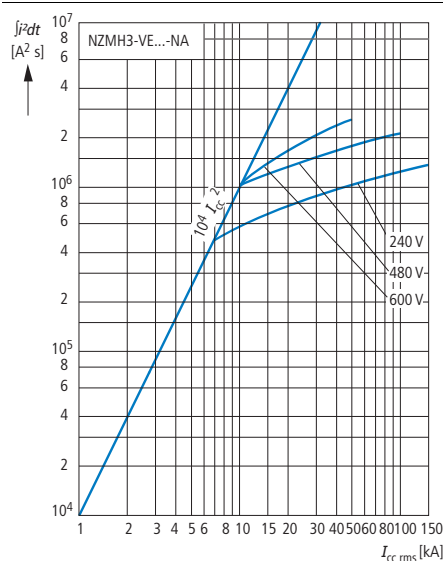
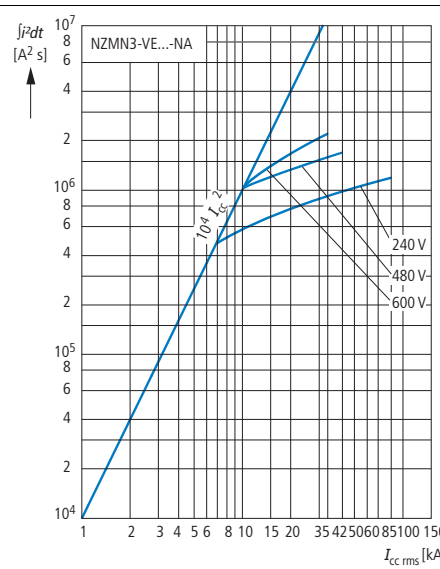
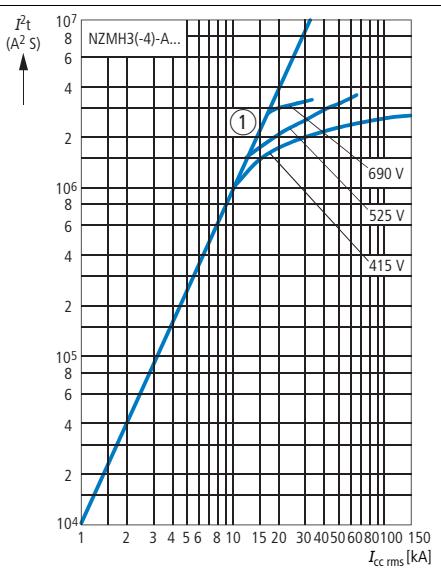
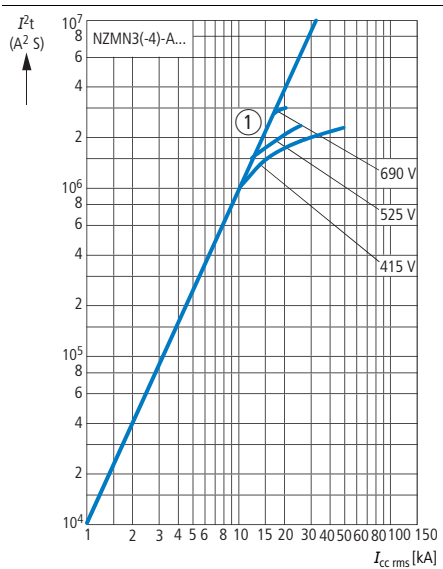
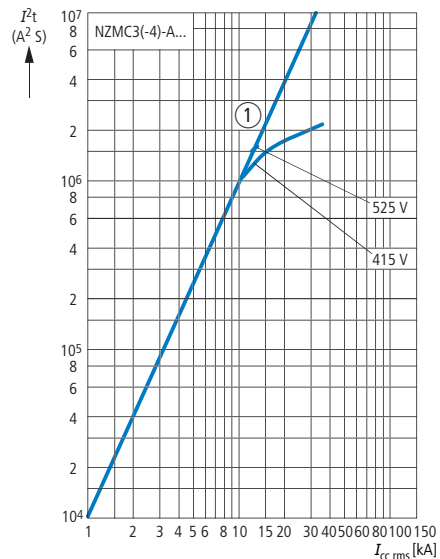
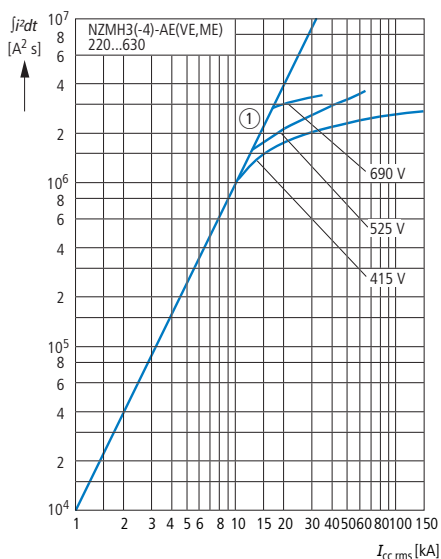
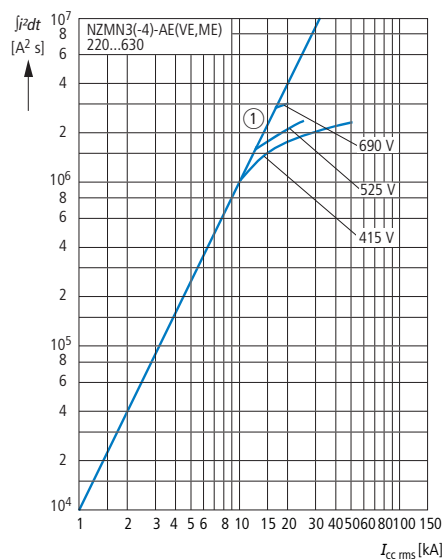

① 1 half-cycle



Frequency response

+NZM2-4-XFIA30
 30 mA

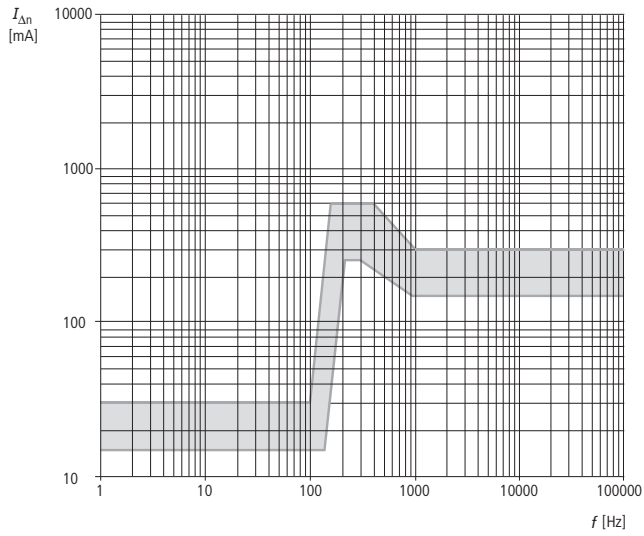

+NZM2-4-XFIA
 100 mA

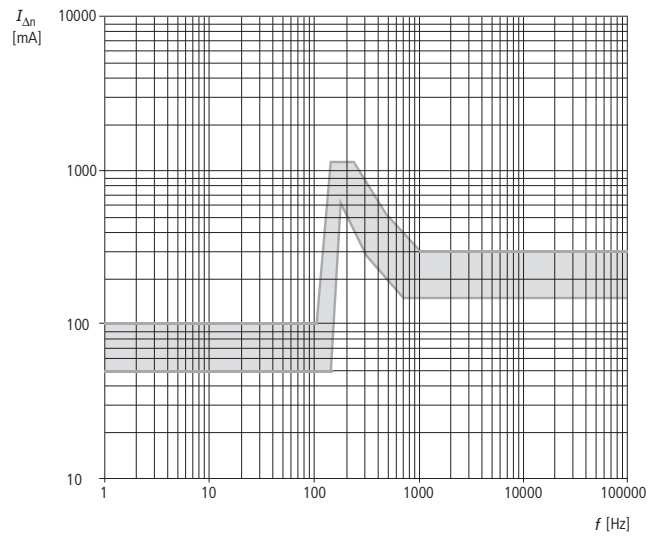

+NZM2-4-XFIA
 300 mA

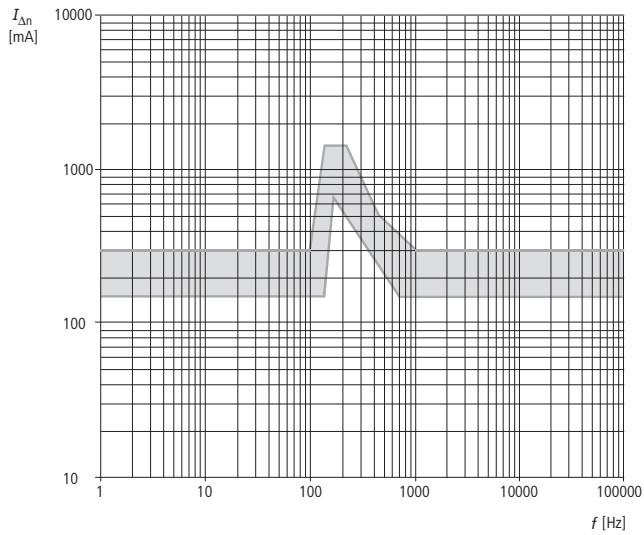

1000 mA

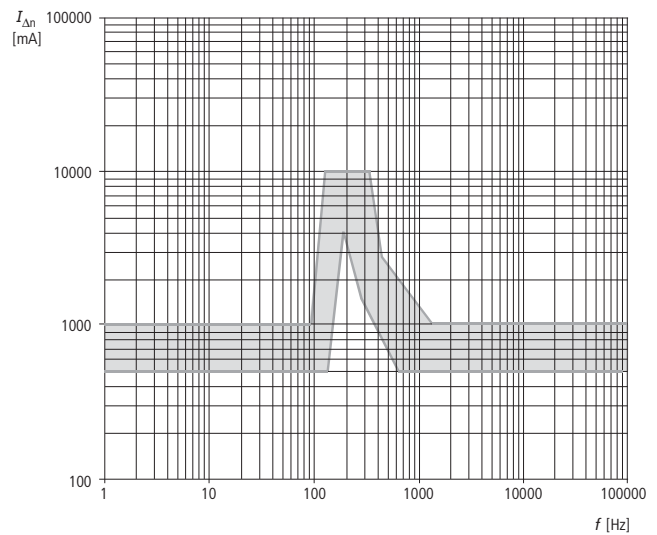

Technical data

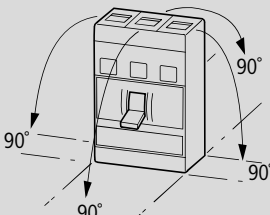
General																																													
Standards		IEC/EN 60947 and VDE 0660																																											
Contact protection		Finger and back-of-hand proof to DIN EN 50274/VDE 0660 Part 514																																											
Climatic proofing		Damp heat, constant, to IEC 60068-2-78 Damp heat, cyclic, to IEC 60068-2-30																																											
Ambient temperature																																													
Storage	°C	-25...+70																																											
Operation	°C	-25...+70																																											
Mechanical shock resistance (IEC/EN 60068-2-27)	g	20 (half-sinusoidal shock 20 ms)																																											
Safe isolation according to EN 61140																																													
Between auxiliary contacts and main contacts	V AC	500																																											
Between the auxiliary contacts	V AC	300																																											
Built-in position		Vertical and 90° in all directions  <ul style="list-style-type: none"> With residual-current release XFI: <ul style="list-style-type: none"> - NZM1, N1, NZM2, N2: vertical and 90° in all directions With plug-in adapter elements <ul style="list-style-type: none"> - NZM1, N1, NZM2, N2: vertical, 90° right/left With withdrawable unit: <ul style="list-style-type: none"> - NZM3, N3: vertical, 90° left - NZM4, N4: vertical With remote operator: <ul style="list-style-type: none"> - NZM2, N(S)2, NZM3, N(S)3, NZM4, N(S)4: vertical and 90° in all directions 																																											
Direction of incoming supply		Any																																											
Degree of protection																																													
Device		In the area of the HMI devices: IP20 (basic degree of protection)																																											
Enclosure		With insulating surround: IP40 With door coupling rotary handle: IP66																																											
Terminal type		Tunnel terminal: IP10 Phase isolator and cable terminal: IP00																																											
		<table border="1" style="width: 100%; border-collapse: collapse;"> <thead> <tr> <th colspan="2">Rated uninterrupted current</th> <th colspan="2">max. 160 A</th> <th colspan="2">max. 300 A</th> <th colspan="2">max. 630 A</th> <th colspan="2">max. 1600 A</th> </tr> <tr> <th></th> <th></th> <th>NZMB1</th> <th>NZMC1</th> <th>NZMN1</th> <th>NZMB2</th> <th>NZMC2</th> <th>NZMN2</th> <th>NZMC3</th> <th>NZMN3</th> <th>NZMN4</th> <th>NZMH4</th> </tr> </thead> <tbody> <tr> <td></td> <td></td> <td></td> <td></td> <td>NZMH1</td> <td></td> <td></td> <td>NZMH2</td> <td></td> <td>NZMH3</td> <td></td> <td></td> </tr> </tbody> </table>										Rated uninterrupted current		max. 160 A		max. 300 A		max. 630 A		max. 1600 A				NZMB1	NZMC1	NZMN1	NZMB2	NZMC2	NZMN2	NZMC3	NZMN3	NZMN4	NZMH4					NZMH1			NZMH2		NZMH3		
Rated uninterrupted current		max. 160 A		max. 300 A		max. 630 A		max. 1600 A																																					
		NZMB1	NZMC1	NZMN1	NZMB2	NZMC2	NZMN2	NZMC3	NZMN3	NZMN4	NZMH4																																		
				NZMH1			NZMH2		NZMH3																																				
Circuit-breaker																																													
Rated impulse withstand voltage U_{imp}																																													
Main contacts	V	6000	6000	6000	8000	8000	8000	8000	8000	8000	8000																																		
Auxiliary contacts	V	6000	6000	6000	6000	6000	6000	6000	6000	6000	6000																																		
Rated operating voltage	U_e V AC	440	690	690	440	690	690	690	690	690	690																																		
	V DC ¹⁾	–	–	500	–	–	750	750	–	–	–																																		
Overvoltage category/degree of pollution		III/3	III/3	III/3	III/3	III/3	III/3	III/3	III/3	III/3	III/3																																		
Rated insulation voltage	U_i V	690	690	690	690	690	1000	1000	1000	1000	1000																																		
For use in IT electrical power networks	V	440	690	690	440	690	690	690	690	525	690 ²⁾																																		

Notes 1) Details apply for 3 pole system protection circuit-breaker with thermomagnetic release NZMN(H)1(2)(3)-A... up to 500 A.
 For rated operating voltage switching on 3 contacts the following applies:
 DC correction factor for instantaneous release
 response value NZM1: 1.25, NZM2: 1.35, NZM3: 1.45
 Setting for I_t at DC = setting I_t AC/correction factor DC

Switching of one pole via two series contacts

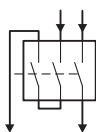

Switching of one pole via three series contacts

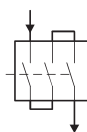

2) > 800 A = 525



NZM...1, NZM...2, NZM...3, NZM...4

				Max. rated uninterrupted current 160 A			
				NZMB1	NZMC1	NZMN1	NZMH1
Switching capacity							
Rated short-circuit making capacity							
	240 V	I_{cm}	kA	63	121	187	220
	400/415 V	I_{cm}	kA	53	76	105	220
	440 V	I_{cm}	kA	53	63	74	74
	525 V	I_{cm}	kA	–	24	40	40
	690 V	I_{cm}	kA	–	14	17	17
Rated short-circuit breaking capacity I_{cu}							
I_{cu} according to IEC/EN 60947							
Operating sequence O-t-CO							
	240 V 50/60 Hz	I_{cu}	kA	30	55	85	100
	400/415 V 50/60 Hz	I_{cu}	kA	25	36	50	100
	440 V 50/60 Hz	I_{cu}	kA	25	30	35	70
	525 V 50/60 Hz	I_{cu}	kA	–	12	20	20
	690 V 50/60 Hz	I_{cu}	kA	–	8	10	10
	500 V DC ³⁾	I_{cu}	kA	–	–	15	30
	750 V DC ³⁾	I_{cu}	kA	–	–	–	–
I_{cs} according to IEC/EN 60947							
Operating sequence O-t-CO-t-CO							
	240 V 50/60 Hz	I_{cs}	kA	30	55	85	100
	400/415 V 50/60 Hz	I_{cs}	kA	25	36	50	50
	440 V 50/60 Hz	I_{cs}	kA	18.5	22.5	35	35
	525 V 50/60 Hz	I_{cs}	kA	–	6	10	10
	690 V 50/60 Hz	I_{cs}	kA	–	4	7.5	7.5
Maximum LV h.b.c. fuse ⁶⁾				A gG/gL			
				NZM.1-...20...100: 200 NZM.1-...125, 160: 315			
Rated short-time withstand current							
$t = 0.3$ s				I_{cw}	kA	–	–
$t = 1$ s				I_{cw}	kA	–	–
Utilization category according to IEC/EN 60947-2							
Rated making and breaking capacity							
Rated operational current							
	AC-1	400/415 V 50/60 Hz	I_e	A	160	160	160
		690 V 50/60 Hz	I_e	A	160	160	160
	AC-3	400/415 V 50/60 Hz	I_e	A	160	160	160
		690 V 50/60 Hz	I_e	A	160	160	160
	DC-1 ³⁾	500 V DC	I_e	A	–	–	125
		750 V DC	I_e	A	–	–	–
	DC-3 ³⁾	500 V DC	I_e	A	–	–	125
		750 V DC	I_e	A	–	–	–
Lifespan, mechanical							
of which max. 50 % trip by shunt/undervoltage release							
Operations				20000	20000	20000	20000
Lifespan, electrical							
	AC-1	400/415 V 50/60 Hz	Operations	7500	7500	10000	10000
		690 V 50/60 Hz	Operations	–	5000	7500	7500
	AC-3	400/415 V 50/60 Hz	Operations	–	–	7500	7500
		690 V 50/60 Hz	Operations	–	–	5000	5000
	DC-1 ³⁾	500 V DC	Operations	–	–	10000	10000
		750 V DC	Operations	–	–	–	–
	DC-3 ³⁾	500 V DC	Operations	–	–	5000	5000
		750 V DC	Operations	–	–	–	–
Max. operating frequency				Ops/h	120	120	120
Heat dissipation per pole at I_n ⁵⁾				W	16.7	16.7	16.7
Total opening delay on short-circuit				ms	< 10	< 10	< 10
Technical data that diverge from products for the IEC market							
Switching capacity of NA switch (UL489, CSA 22.2 No. 5-09)							
Short-circuit current rating (SCCR)							
	240 V 60 Hz		kA	35	–	85	–
	480 V 60 Hz		kA	25 ¹⁾	–	35 ¹⁾	–
	600 V 60 Hz		kA	–	–	–	–

Notes

- ¹⁾ Switching capacity of NA switches with NZM...1-...(C)NA: 480 V/277 V
- ²⁾ For rated operational current AC-3 with NZM4: 400 V: max. 650 kW; 690 V: max. 600 kW
- ³⁾ DC data apply only for NZM...A... with thermomagnetic release
- ⁴⁾ For switching capacity NZM2...NA: 600 V/347 V
- ⁵⁾ For thermal losses per pole the specification refers to the maximum rated operational current of the construction size
- ⁶⁾ Maximum back-up fuse, if the expected short-circuit currents at the installation location exceed the switching capacity of the circuit-breaker
- ⁷⁾ For higher switching capacity please inquire

NZM...1, NZM...2, NZM...3, NZM...4

Max. rated uninterrupted current 300 A				Max. rated uninterrupted current 630 A			Max. rated uninterrupted current 1600 A	
NZMB2	NZMC2	NZMN2	NZMH2	NZMC3	NZMN3	NZMH3	NZMN4	NZMH4
63	121	187	330	121	187	330	105	275
53	76	105	330	76	105	330	105	187
53	63	74	286	63	74	286	74	187
–	24	53	105	24	53	143	53	143
–	9	40	40	14	40	74	40	105
30	55	85	150	55	85	150	50	125
25	36	50	150	36	50	150	50	85
25	30	35	130	30	35	130	35	85 ⁷⁾
–	12	25	50	12	25	65	25	65
–	8	20	20	8	20	35	20	50
–	–	30	60	–	30	70	–	–
–	–	30	60	–	30	70	–	–
30	55	85	150	55	85	150	37	63
25	36	50	150	36	50	150	37	43
18.5	22.5	35	130	22.5	35	130	26	43
–	6	25	37.5	9	13	33	19	49
–	4	5	5	4	5	9	15	37
355	355	355	355	NZMC3...500: 630	NZMH3-...250, 400: 400 NZMH3...500: 630 NZMH3...630: 630	NZMH3-...250, 400: 400 NZMH3...500: 630 NZMH3...630: 630	NZMN4-...630...1250: 2 x 630 NZMN4-...1600: 2 x 800	
–	–	1.9	1.9	3.3	3.3	3.3	19.2	19.2
–	–	1.9	1.9	3.3	3.3	3.3	19.2	19.2
A	A	A	A	A	A	A	B	B
300	300	300	300	500	630	630	1600	1600
250	250	250	250	500	630	630	1600	1600
300	300	300	300	450	450	450	1600²⁾	1600²⁾
250	250	250	250	450	450	450	1600 ²⁾	1600 ²⁾
–	–	250	250	–	500	500	–	–
–	–	250	250	–	500	500	–	–
–	–	250	250	–	500	500	–	–
–	–	250	250	–	500	500	–	–
20000	20000	20000	20000	15000	15000	15000	10000	10000
7500	7500	10000	10000	5000	5000	5000	3000	3000
–	7500	7500	7500	3000	3000	3000	2000	2000
–	–	6500	6500	2000	2000	2000	2000	2000
–	5000	5000	5000	2000	2000	2000	1000	1000
–	–	7500	7500	–	5000	5000	–	–
–	–	7500	7500	–	5000	5000	–	–
–	–	3000	3000	–	2000	2000	–	–
–	–	3000	3000	–	2000	2000	–	–
120	120	120	120	60	60	60	60	60
19	19	19	19	31	31	31	97	97
< 10	< 10	< 10	< 10	< 10	< 10	< 10	< 25 ≤ 415 V; < 35 > 415 V	< 25 ≤ 415 V; < 35 > 415 V
35	–	85	150	–	85	150	85	125
25	–	35	100	–	42	100	42	85
18 ⁴⁾	–	25 ⁴⁾	50 ⁴⁾	–	35	50	35	50



17/168 NZM circuit-breakers

Circuit-breakers, switch-disconnectors for 1000 V AC/DC

NZMH...S1, N...4...S1-DC

Circuit-breakers for 1000 V AC			NZMH2...S1 max. 300 A	NZMH3...S1 max. 630 A	NZMH4...S1 max. 1600 A
Rated operating voltage	U_e	V AC	1000	1000	1000
Rated uninterrupted current	I_u	A	300/50 °C	630/50 °C	1600/50 °C
Rated operational current AC-1			300	630	1600
Rated short-circuit making capacity 1000 V 50/60 Hz	I_{cm}	kA	17	17	40
Rated short-circuit breaking capacity I_{cn}					
I_{cu} according to IEC/EN 60947 Operating sequence O-t-CO	I_{cu}	kA	10	15	20
I_{cs} according to IEC/EN 60947 Operating sequence O-t-CO-t-CO	I_{cs}	kA	3	10	15
Utility category			A	A	A/B
Maximum operating frequency		Ops/h	120	60	60
Durability					
Mechanical (of which max. 50 % trip by shunt/ undervoltage release)		Operations	20000	15000	10000
Electrical, AC-1 1000 V		Operations	3000	1000	500
Rated insulation voltage	U_i	V AC	1000	1000	1000
For use in IT electrical power networks			–	–	–

Switch-disconnectors for 1000 V DC			N2-4...S1-DC max. 200 A	N3-4...S1-DC max. 500 A	N4-4...S1-DC max. 1400 A
Rated operating voltage	U_e	V DC	1000	1000	1000
Rated uninterrupted current with terminal jumpers	I_u	A	200/65 °C	500/65 °C	1400/65 °C
Rated operational current	I_e		200 (DC 22-B)	500 (DC 22-B)	1400 (DC 21-B)
Rated short-time withstand current $t = 0.1$ s	I_{cw}	kA	3	6	25
Rated conditional short-circuit current	I_q	kA	15	15	–
With back-up fuse		A_gR	200	500	–
Maximum operating frequency		Ops/h	120	60	60
Durability					
Mechanical (of which max. 50 % trip by shunt/ undervoltage release)		Operations	20000	15000	10000
Electrical, 1000 V DC		Operations	2500 (DC 22-B)	1000 (DC 22-B)	500 (DC 21-B)
Rated insulation voltage	U_i	V DC	1250	1250	1250
For use in IT electrical power networks		V DC	1000	1000	1000

Notes

NZM...S1 and N...S1-DC can not be combined with withdrawable units and/or connection on rear.
 Can not be combined with early-make auxiliary contacts NZM-...XHIV or box terminal NZM2-4-XKC at $U_i > 1000$ V DC.
 Terminal type N...S1-DC:
 for 2 pole switches series connection of two poles each is required. See jumper kit NZM...-4-XKV2P

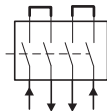

			PN1/N1 max. 160 A	PN2/N2 max. 250 A	PN3/N3 max. 630 A	N4 max. 1600 A
Switch-disconnectors						
Rated impulse withstand voltage U_{imp}						
Main contacts		V	6000	8000	8000	8000
Auxiliary contacts		V	6000	6000	6000	6000
Rated operating voltage AC (40-60 Hz)	U_e	V AC	690	690	690	690
Max. rated uninterrupted current IEC/EN 60947-3	I_u	A	160	250	630	1600
Overvoltage category/degree of pollution			III/3	III/3	III/3	III/3
Rated insulation voltage	U_i	V AC	690	690	1000	1000
For use in IT electrical power networks		V	690	690	690	525
Switching capacity						
Rated short-circuit making capacity	I_{cm}	kA	2.8	5.5	25	53
Rated short-time withstand current						
$t = 0.3$ s	I_{cw}	kA	2	3.5 ¹⁾	12	25
$t = 1$ s	I_{cw}	kA	2	3.5 ¹⁾	12	25
Rated conditional short-circuit current I_q						
With back-up fuse		A gG/gL	PN1(N1)-63...125: 125 PN1(N1)-160: 160	PN2(N2)-160...250: 250	PN3(N3)-400...630: 630	N4-630...1600: 2 x 800
400/415 V		kA	100	100	100	100
690 V		kA	80	80	80	80
With downstream fuse		A gG/gL	PN1(N1)-63...125: 125 PN1(N1)-160: 160	PN2(N2)-160...250: 250	PN3(N3)-400...630: 630	N4-630...1600: 2 x 800
400/415 V		kA	100	100	100	100
690 V		kA	10	80	80	80
Rated making and breaking capacity						
Rated operational current AC-22/23A						
415 V	I_e	A	160	250	630	1600
690 V	I_e	A	160	250	630	1600
Lifespan, mechanical	Operations		20000	20000	15000	10000
Maximum operating frequency		Ops/h	120	120	60	60
Lifespan, electrical according to IEC/EN 60947-4-1 Annex B						
AC-1						
400/415 V	Operations		10000	10000 ⁴⁾	5000	3000
690 V	Operations		7500	7500 ⁴⁾	3000	2000
AC-3						
400/415 V	Operations		7500	7500 ⁵⁾	3000	2000
690 V	Operations		5000	5000 ³⁾⁵⁾	2000	1000
Heat dissipation per pole at I_u ²⁾		W	12.7	16	40	97

Notes

- ¹⁾ The rated short-time withstand current for PN2/N2 in conjunction with residual-current release NZM2-4-XFI... $I_{cw} = 1.5$ kA
- ²⁾ For thermal losses per pole the specification refers to the maximum rated operational current of the construction size.
- ³⁾ For the electrical life at AC-3 for PN2/N2 the following applies: 690 V: max. 160 kW
- ⁴⁾ For 4 pole switch-disconnectors the following applies: 400/415 V 7500 switching operations; 690 V 5000 switching operations
- ⁵⁾ For 4 pole switch-disconnectors the following applies: 400/415 V 6000 switching operations; 690 V 4000 switching operations



17/170 Circuit-breakers, switch-disconnectors

Molded Case Switch

NS...-...NA

				NS1...-NA max. 125A	NS2...-NA max. 250A	NS3...-NA max. 600A	NS4...-NA max. 1200A			
Molded Case Switch										
Rated peak withstand current			U_{imp}							
Main contacts			V	6000	8000	8000	8000			
Auxiliary contacts			V	6000	6000	6000	6000			
Rated operating voltage			U_e	VAC	690	690	690			
Max. rated uninterrupted current										
IEC/EN 60947-2 Annex L			I_n	A	125	250	600	1200		
UL489/CSA 22.2 No. 5.1			I_n	A	125	250	600	1200		
Overvoltage category/pollution degree					III/3	III/3	III/3	III/3		
Rated insulation voltage			U_{imp}	V	690	1000	1000	1000		
Switching capacity according to UL 489, CSA 22.2 No. 5.1										
				KA	85	150	150	85		
				KA	35	100	100	65		
				KA	–	50	50	42		
Switching capacity divergent from products for North America.										
Rated short-circuit making capacity										
	240 V 50/60 Hz		I_{cm}	KA	187	330	330	187		
	400/415 V 50/60 Hz		I_{cm}	KA	105	330	330	154		
	440 V 50/60 Hz		I_{cm}	KA	74	286	286	143		
	525 V 50/60 Hz		I_{cm}	KA	53	105	143	84		
	690 V 50/60 Hz		I_{cm}	KA	17	53	74	74		
Rated short-circuit breaking capacity										
$I_{cc} = I_{cu}$ To IEC/EN 60947-2 Annex L	I_{cu} to IEC/EN 60947 test cycle O-t-CO	240 V 50/60 Hz	I_{cu}	KA	85	150	150	85		
		400/415 V 50/60 Hz	I_{cu}	KA	50	150	150	70		
		440 V 50/60 Hz	I_{cu}	KA	35	130	130	65		
		525 V 50/60 Hz	I_{cu}	KA	20	50	85	40		
		690 V 50/60 Hz	I_{cu}	KA	10	20	35	35		
		240 V 50/60 Hz	I_{cs}	KA	85	150	150	43		
	I_{cs} according to IEC/EN 60947 test cycle O-t-CO-t-CO	400/415 V 50/60 Hz	I_{cs}	KA	50	150	150	35		
		440 V 50/60 Hz	I_{cs}	KA	35	130	130	33		
		525 V 50/60 Hz	I_{cs}	KA	10	37.5	33	20		
		690 V 50/60 Hz	I_{cs}	KA	7.5	5	9	18		
		Lifespan, mechanical (of which max. 50 % trip by shunt/undervoltage release)			Operations		20000	20000	15000	10000
		Maximum operating frequency			ops./h		120	120	60	60
Lifespan, electrical	AC-1	400/415 V 50/60 Hz	Operations		10000	10000	5000	3000		
		690 V 50/60 Hz	Operations		7500	7500	3000	2000		
	AC-3	400/415 V 50/60 Hz	Operations		7500	6500	2000	2000		
		690V 50/60 Hz	Operations		5000	5000	2000	1000		
Heat dissipation per pole at I_u ¹⁾			W		8.7	19	40	97		
Total downtime on short-circuit			ms		< 10	< 10	< 10	< 25 ≤ 415 V < 35 > 415 V		

Notes

¹⁾ Figures apply to the maximum rated operational current of the construction size



Circuit-breaker		Volts AC 60Hz (V)	Threshold current			Intermediate current			High interrupting capacity		
Part no.	Cont. amps (A)		rms sym (kA)	Maximum		rms sym (kA)	Maximum		rms sym (kA)	Maximum	
				Peak (kA)	I^2dt (kA ² s)		Peak (kA)	I^2dt (kA ² s)		Peak (kA)	I^2dt (kA ² s)
NZM B1 A.../AF...NA	125 A	240	8.125	7.4	0.18	22	13.53	0.33	35	16.78	0.35
		480	8.125	9.22	0.38	18	15.16	0.67	25	26.55	0.78
NZM N1- A.../AF...NA	125 A	240	8.125	7.4	0.18	50	18.53	0.38	85	19.16	0.36
		480	8.125	9.22	0.38	22	18.55	0.97	35	20.58	1.02
NZMB2- A.../AF...NA	250 A	240	16.25	13.00	0.4	22	14.5	0.6	35	15.5	0.4
		480	15	14	0.6	22	13.5	0.45	25	16.5	0.6
		600	10	12	0.5	14	14.5	0.75	18	15.5	0.75
NZMN2- A.../AF...NA	250 A	240	16.25	13	0.4	50	17	0.45	85	19.5	0.45
		480	16.25	13.5	0.6	22	14.5	0.6	35	20	0.65
		600	15	14.5	0.7	22	16.5	0.8	25	17	0.75
NZMN2- VE(F)-NA	250 A	240	16.25	12	0.45	50	18	0.4	85	19.5	0.4
		480	16.25	14.5	0.5	22	18	0.65	35	20	0.6
		600	15	14.5	0.6	22	17	0.75	25	18	0.65
NZMH2- A.../AF...NA	125 A	240	8.125	9	0.3	100	19	0.35	200	21.5	0.35
		480	8.125	9	0.35	55	23	0.7	150	29	0.85
		600	8.125	10	0.4	42	22.5	0.7	55	26	0.8
NZMH2- A.../AF...NA	250 A	240	16.25	13	0.4	100	20.5	0.4	150	20	0.4
		480	16.25	13.5	0.5	65	24	0.9	100	27	0.8
		600	16.25	13	0.6	30	20	0.7	50	25	0.9
NZMH2- VE.../VEF...NA	250 A	240	16.25	11.5	0.4	100	18.5	0.3	150	21	0.4
		480	16.25	14.5	0.5	65	24	0.6	100	27	0.7
		600	16.25	14.5	0.5	30	20	0.6	50	25	0.8
NZMN3- VE...NA	250 A	39	24.5	1	-	-	-	85	33.5	1.1	240
		25	27	1.8	-	-	-	42	35	1.8	480
		20	25	1.8	-	-	-	35	34	2.6	600
NZMH3- VE...NA	600 A	240	39	45	4.5	100	35	2	150	40	2.5
		480	39	35	2.5	65	39	3	100	47	3
		600	30	31	2.4	42	37	3	50	42	2.8

Part no.	Weight kg
Circuit-breakers	
NZM...1-...	1.046
NZM...1-4-...	1.325
NZM...2-...	2.345
NZM...2-4-...	3.5
NZM...3-...	6.34
NZM...3-4-...	8.4
NZM...4-...	21
NZM...4-4-...	27
Plug-in adapter elements	
+NZM2-XSV	4.7
+NZM2-4-XSV	5.9
Withdrawable units	
+NZM3-XAV	21
+NZM3-4-XAV	27
+NZM4-XAV	52
+NZM4-4-XAV	65

Part no.	Weight kg
Switch-disconnectors	
PN1-..., N1-...	0.926
PN1-4-..., N1-4-...	1.325
PN2-..., N2-...	2.15
PN2-4-..., N2-4-...	2.65
PN3-..., N3-...	5.7
PN3-4-..., N3-4-...	7.1
N4-...	17
N4-4-...	22



17/172 NZM circuit-breakers

Temperature dependency, derating
NZM...A(F), NZM...M(S)

Device part no.	Release type	Response time of the overload release at temperatures deviating from the reference temperatures						
		Temperature compensation coefficient						
		20 °C	30 °C	40 °C	50 °C	60 °C	65 °C	70 °C
Thermomagnetic release (TM)		System protection (reference temperature 40 °C)						
System protection		System protection (reference temperature 40 °C)						
NZM...1(-4)-A(F)15...80(-NA)	TM	1.14	1.07	1	0.93	0.86	0.83	0.79
NZM...1(-4)-A(F)90...125(-NA)	TM	1.14	1.07	1	0.93	0.86	0.83	0.79
NZM...1(-4)-A160	TM	1.08	1.04	1	0.96	0.92	0.90	0.88
NZM...1-A20...125-SVE	TM with SVE	1.14	1.07	1	0.93	0.86	0.83	0.79
NZM...2(-4)-A(F)15...200(-NA)	TM	1.04	1.02	1	0.98	0.96	0.95	0.94
NZM...2(-4)-A(F)250(-NA)	TM	1.04	1.02	1	0.98	0.96	0.95	0.94
NZM...2(-4)-A20...200-SVE	TM with SVE	1.04	1.02	1	0.98	0.96	0.95	0.94
NZM...2(-4)-A250-SVE	TM with SVE	1.04	1.02	1	0.98	0.96	0.95	0.94
NZM...3(-4)A-250...500	TM	1.12	1.06	1	0.94	0.88	0.85	0.82
NZM...3(-4)A-250...500	TM with XAV	1.06	1	0.94	0.88	0.82	0.79	0.76
Short-circuit/motor protection		Motor protection (reference temperature 20 °C)						
NZM...1-M(S)40...80(-CNA)	TM	1	0.98	0.95	0.93	0.90	0.89	0.88
NZM...1-M(S)100(-CNA)	TM	1	0.98	0.95	0.93	0.90	0.89	0.88
NZM...1-M(S)40...100-SVE	TM with SVE	1	0.98	0.95	0.93	0.90	0.89	0.88
NZM...2-M(S)20...200(-CNA)	TM	1	0.98	0.96	0.94	0.92	0.91	0.90
NZM...2-M(S)20...200-SVE	TM with SVE	1	0.98	0.96	0.94	0.92	0.91	0.90
NZM...3-S250...500	TM with/without XAV	1	1	1	1	1	1	1

Notes

If temperatures deviate from the reference temperature, a slight change of the overload protection properties occurs. To determine the response time from the tripping characteristics, the temperature compensation coefficients listed in the table must be considered.

Example:

An NZM1-A100 is calibrated for a reference temperature of 40 °C.

What happens when it is operated at an ambient temperature of 60 °C ?

At 60 °C, the temperature compensation coefficient of 0.86 results in a reduced operating current of $I_r = 100$

A x 0.86 = 86 A. In other words at an ambient temperature of 60 °C the NZM1-A100 trips as if it were set to 86 A.

Device part no.	Release type	Reduction of the rated operational current (derating) under particular ambient conditions (according to IEC 947)						
		Derating coefficient						
		20 °C	30 °C	40 °C	50 °C	60 °C	65 °C	70 °C
Thermomagnetic release (TM)		System protection (reference temperature 40 °C)						
System protection		System protection (reference temperature 40 °C)						
NZM...1(-4)-A(F)15...80(-NA)	TM	1	1	1	1	1	1	1
NZM...1(-4)-A(F)90...125(-NA)	TM	1	1	1	1	0.86	0.83	0.8
NZM...1(-4)-A160	TM	1	1	1	0.95	0.9	0.85	0.8
NZM...1-A20...100-SVE	TM with SVE	1	1	1	1	1	1	1
NZM...1-A125-SVE	TM with SVE	1	0.92	0.87	0.81	–	–	–
NZM...2(-4)-A(F)15...200(-NA)	TM	1	1	1	1	1	1	1
NZM...2(-4)-A(F)250(-NA)	TM	1	1	1	1	0.9	0.85	0.8
NZM...2(-4)-A20...200-SVE	TM with SVE	1	1	1	1	1	1	1
NZM...2(-4)-A250-SVE	TM with SVE	1	0.97	0.92	0.87	0.81	–	–
NZM...3(-4)A-250...500	TM	1	1	1	0.94	0.88	0.85	0.82
NZM...3(-4)A-250...500	TM with XAV	1	1	0.94	0.88	0.82	0.79	0.76
Short-circuit/motor protection		Motor protection (reference temperature 20 °C)						
NZM...1-M(S)40...80(-CNA)	TM	1	1	1	1	1	1	1
NZM...1-M(S)100(-CNA)	TM	1	1	1	1	0.86	0.83	0.8
NZM...1-M(S)40...100-SVE	TM with SVE	1	0.92	0.87	0.81	–	–	–
NZM...2-M(S)20...200(-CNA)	TM	1	1	1	1	1	1	1
NZM...2-M(S)20...200-SVE	TM with SVE	1	1	1	1	1	1	1
NZM...3-S250...500		1	1	1	0.94	0.88	0.85	0.82
NZM...3-S250...500	TM with XAV	1	1	1	0.94	0.88	0.85	0.82
NZM...3-S250...400	TM	1	1	1	1	1	1	1
NZM...3-S250...400	TM with XAV	1	1	1	1	1	0.97	0.94

Notes

In determining the maximum permissible current loads at different ambient temperatures, the derating coefficients listed in the table must be considered.

Example:

An NZM2-A250 should be operated at an ambient air temperature of 65 °C.

How high is the permissible rated operational current I_e ?

At 65 °C the derating coefficient is 0.85, i.e. $I_e = 250 \text{ A} \times 0.85 = 212.5 \text{ A}$.

At an ambient temperature of 65 °C the NZM2-A250 can therefore be operated at up to $I_e = 212.5 \text{ A}$.

Device part no.	Release type	Reduction of the rated operational current (derating) under particular ambient conditions (according to IEC 947)						
		Derating coefficient						
		20 °C	30 °C	40 °C	50 °C	60 °C	65 °C	70 °C
Electronic release (E)								
System protection								
NZM...3(-4)-AE(F)250...500(-NA)	E	1	1	1	1	1	1	1
NZM...3(-4)-AE(F)550...630(-NA)	E	1	1	1	1	0.9	0.85	0.8
NZM...3(-4)-AE250...400 + XAV	E with XAV	1	1	1	1	1	1	1
NZM...3(-4)-AE630 + XAV	E with XAV	0.96	0.92	0.87	0.83	0.78	0.75	0.73
NZM...4(-4)-AE(F)600...1250(-NA)	E	1	1	1	1	1	1	1
NZM...4(-4)-AE1600	E	1	1	1	1	0.87	0.85	0.82
NZM...4(-4)-AE630...1250 + XAV	E with XAV	1	1	1	1	1	1	1
NZM...4(-4)-AE1600 + XAV	E with XAV	1	0.98	0.93	0.89	0.85	0.83	0.8
Selectivity and generator protection								
NZM...2(-4)-VE(F)100...175(-NA) (-S1)	E	1	1	1	1	1	1	1
NZM...2(-4)-VE(F)200...250(-NA) (-S1)	E	1	1	1	1	0.9	0.85	0.8
NZM...2(-4)-VE100...160 + XSV	E with XSV	1	1	1	1	1	1	1
NZM...2(-4)-VE250 + XSV	E with XSV	1	1	1	0.94	0.88	0.84	0.81
NZM...3(-4)-VE(F)250...500(-NA)	E	1	1	1	1	1	1	1
NZM...3(-4)-VE(F)550...630(-NA)	E	1	1	1	1	0.9	0.85	0.8
NZM...3(-4)-VE250...400 + XAV	E with XAV	1	1	1	1	1	1	1
NZM...3(-4)-VE630 + XAV	E with XAV	0.96	0.92	0.87	0.83	0.78	0.75	0.73
NZM...4(-4)-VE(F)600...1250(-NA) (-S1)	E	1	1	1	1	1	1	1
NZM...4(-4)-VE1600 (-S1)	E	1	1	1	1	0.87	0.85	0.82
NZM...4(-4)-VE630...1250 + XAV	E with XAV	1	1	1	1	1	1	1
NZM...4(-4)-VE1600 + XAV	E with XAV	1	0.98	0.93	0.89	0.85	0.83	0.8
Motor protection								
NZM...2-ME(SE)90...140(-CNA)	E	1	1	1	1	1	1	1
NZM...2-ME(SE)220(-CNA)	E	1	1	1	1	0.9	0.85	0.8
NZM...2-ME90...140 + XSV	E with XSV	1	1	1	1	1	1	1
NZM...2-ME220 + XSV	E with XSV	1	1	1	0.94	0.88	0.84	0.81
NZM...3-ME(SE)220...350(-CNA) (-S1)	E	1	1	1	1	1	1	1
NZM...3-ME(SE)450(-CNA) (-S1)	E	1	1	1	1	1	1	1
NZM...3-ME220...350 + XAV	E with XAV	1	1	1	1	1	1	1
NZM...3-ME450 + XAV	E with XAV	0.96	0.92	0.87	0.83	0.78	0.75	0.73
NZM...4-ME550...875 (-S1)	E	1	1	1	1	1	1	1
NZM...4-ME1400 (-S1)	E	1	1	1	1	1	1	1
NZM...4-ME550...875 + XAV	E with XAV	1	1	1	1	1	1	1
NZM...4-ME1400 + XAV	E with XAV	1	0.98	0.93	0.89	0.85	0.83	0.8
Switch-disconnectors/Molded Case Switch								
N1(-4) -63, PN1(-4)-63, NS1-63-NA		1	1	1	1	1	1	1
N1(-4) -100...125, PN1(-4)-100...125, NS1-100...125-NA		1	1	1	1	0.86	0.83	0.8
N1(-4) -160, PN1(-4)-160		1	1	1	0.95	0.9	0.85	0.8
N2(-4) -160...200, PN2(-4)-160...200, NS2-160...200-NA		1	1	1	1	1	1	1
N2(-4) -250, PN2(-4)-200, NS2-250-NA		1	1	1	1	0.9	0.85	0.8
N2(-4) -160...200 + XSV		1	1	1	1	1	1	1
N2(-4) -250, NS2-250-NA		1	0.97	0.92	0.87	0.81	-	-
N3(-4) -400, PN3(-4)-400, NS3-400-NA		1	1	1	1	1	1	1
N3(-4) -630, PN3(-4)-630, NS3-600-NA		1	1	1	0.94	0.89	0.86	0.84
N3(-4) -400 + XAV		1	1	1	1	1	1	1
N3(-4) -630 + XAV		0.96	0.92	0.87	0.83	0.78	0.75	0.73
N4(-4) -630...1250, NS4-800...1200-NA		1	1	1	1	1	1	1
N4(-4) -1600		1	1	1	1	0.87	0.85	0.82
N4(-4) -630...1250 + XAV		1	1	1	1	1	1	1
N4(-4) -1600 + XAV		1	0.98	0.93	0.89	0.85	0.83	0.8
Multi-function component adapters								
NZM...3-630...+NZM3-XAD630	with XAD	1	0.96	0.92	0.88	0.84	0.82	0.8

Notes

In determining the maximum permissible current loads at different ambient temperatures, the derating coefficients listed in the table must be considered.

Example:

An NZM2-A250 should be operated at an ambient air temperature of 65 °C.

How high is the permissible rated operational current I_e ?

At 65 °C the derating coefficient is 0.85, this means $I_e = 250 \text{ A} \times 0.85 = 212.5 \text{ A}$.

The NZM2-A250 may be operated at an ambient temperature of 65 °C with a maximum $I_e = 212.5 \text{ A}$.



NZM up to 500 A with thermomagnetic release (3 and 4 pole)

I _n [A]	Fixed mounted								NS1-		N1-, PN1-	
	NZM1-		M...		AF...-NA		S...-CNA		...-NA			
	A...(-NA)		P	B	P	B	P	B	P	B	P	B
	[W]	[μohms]	[W]	[μohms]	[W]	[μohms]	[W]	[μohms]	[W]	[μohms]	[W]	[μohms]
1.2	-	-	-	-	-	-	1.8	413000	-	-	-	-
1.6	-	-	-	-	-	-	-	-	-	-	-	-
2	-	-	-	-	-	-	0.8	66000	-	-	-	-
2.4	-	-	-	-	-	-	-	-	-	-	-	-
3	-	-	-	-	-	-	1.8	66000	-	-	-	-
5	-	-	-	-	-	-	0.7	9180	-	-	-	-
8	-	-	-	-	-	-	1.8	9180	-	-	-	-
12	-	-	-	-	-	-	0.7	1670	-	-	-	-
15	-	-	-	-	5.5	8180	-	-	-	-	-	-
18	-	-	-	-	-	-	1.6	1670	-	-	-	-
20	9.8	8180	-	-	9.8	8180	-	-	-	-	-	-
25	8.8	4680	-	-	8.8	4680	-	-	-	-	-	-
26	-	-	-	-	-	-	2.0	1050	-	-	-	-
30	-	-	-	-	8.2	3030	-	-	-	-	-	-
32	9.3	3030	-	-	-	-	-	-	-	-	-	-
33	-	-	-	-	-	-	3.4	1050	-	-	-	-
35	-	-	-	-	8.2	2220	-	-	-	-	-	-
40	10.7	2220	13.5	2810	10.7	2220	2.7	562	-	-	-	-
45	-	-	-	-	10.7	1760	-	-	-	-	-	-
50	13.2	1760	14.1	1880	13.2	1760	4.2	562	-	-	-	-
60	-	-	-	-	12.9	1190	-	-	-	-	-	-
63	14.2	1190	14.9	1250	-	-	6.7	562	6.7	562	6	380
70	-	-	-	-	12.5	850	-	-	-	-	-	-
80	16.3	850	20.8	1085	16.3	850	10.8	562	-	-	-	-
90	-	-	-	-	17.7	730	-	-	-	-	-	-
100	21.9	730	23.9	795	21.9	730	16.9	562	16.9	562	11.4	380
110	-	-	-	-	20.7	570	-	-	-	-	-	-
125	26.7	570	-	-	26.7	570	-	-	26.3	562	17.8	380
150	-	-	-	-	-	-	-	-	-	-	-	-
160	36.1	470	-	-	-	-	-	-	-	-	29.2	380
175	-	-	-	-	-	-	-	-	-	-	-	-
200	-	-	-	-	-	-	-	-	-	-	-	-
225	-	-	-	-	-	-	-	-	-	-	-	-
250	-	-	-	-	-	-	-	-	-	-	-	-
300	-	-	-	-	-	-	-	-	-	-	-	-
400	-	-	-	-	-	-	-	-	-	-	-	-
500	-	-	-	-	-	-	-	-	-	-	-	-

NZM2/3/4 with electronic release

I _n [A]	Fixed mounted	
	NZM2-...	NZM3-...
	P [W]	B [μohms]
200	-	-
250	52	275
450	-	-
630	119	100
1250	-	-
1400	-	-
1600	284	37

N2/3/4, PN2/3

I _n [A]	Fixed mounted			
	N2-..., PN2-...		N2-4-...-S1-DC (N+L1+L2+L3)	
	P [W]	B [μohms]	P [W]	B [μohms]
200	-	-	44	275
250	48	256	-	-
450	-	-	122	150
630	107	90	-	-
1250	-	-	231	37
1400	-	-	290	37
1600	284	37	-	-

Additional plug-in units

I _n [A]	NZM1-...	
	P [W]	B [μohms]
125	14	300
250	19	100
630	83	70
1600	77	10

Additional withdrawable units

I _n [A]	NZM3-...	
	P [W]	B [μohms]
630	83	70
1600	77	10

Fixed mounted													
NZM2-								NS2-		N2-, PN2-		NZM3-	
A...(-NA)		M...		AF...-NA		S...-CNA		...-NA				A.../S...	
P	B	P	B	P	B	P	B	P	B	P	B	P	B
[W]	[μohms]	[W]	[μohms]	[W]	[μohms]	[W]	[μohms]	[W]	[μohms]	[W]	[μohms]	[W]	[μohms]
-	-	-	-	-	-	-	-	-	-	-	-	-	-
-	-	-	-	-	-	5.8	750000	-	-	-	-	-	-
-	-	-	-	-	-	-	-	-	-	-	-	-	-
-	-	-	-	-	-	7.8	450000	-	-	-	-	-	-
-	-	-	-	-	-	-	-	-	-	-	-	-	-
-	-	-	-	-	-	0.3	4600	-	-	-	-	-	-
-	-	-	-	-	-	0.9	4600	-	-	-	-	-	-
-	-	-	-	-	-	0.5	1200	-	-	-	-	-	-
-	-	-	-	2.9	4250	-	-	-	-	-	-	-	-
-	-	-	-	-	-	1.2	1200	-	-	-	-	-	-
5.1	4250	5.1	4250	5.1	4250	-	-	-	-	-	-	-	-
8	4250	8	4250	5.9	3140	-	-	-	-	-	-	-	-
-	-	-	-	-	-	1.6	780	-	-	-	-	-	-
-	-	-	-	8.5	3140	-	-	-	-	-	-	-	-
9.6	3140	9.6	3140	-	-	-	-	-	-	-	-	-	-
-	-	-	-	-	-	2.5	780	-	-	-	-	-	-
-	-	-	-	10.3	2800	-	-	-	-	-	-	-	-
13.4	2800	13.4	2800	13.4	2800	1.5	317	-	-	-	-	-	-
-	-	-	-	13.8	2270	-	-	-	-	-	-	-	-
17	2270	17	2270	17	2270	2.4	317	-	-	-	-	-	-
-	-	-	-	18.4	1700	-	-	-	-	-	-	-	-
20.2	1700	20.2	1700	-	-	3.8	317	-	-	-	-	-	-
-	-	-	-	15.7	1070	-	-	-	-	-	-	-	-
20.5	1070	20.5	1070	20.5	1070	6.1	317	-	-	-	-	-	-
-	-	-	-	20.8	855	-	-	-	-	-	-	-	-
25.7	855	25.7	855	25.7	855	9.5	317	-	-	-	-	-	-
-	-	-	-	21.4	589	-	-	-	-	-	-	-	-
27.6	589	27.6	589	27.6	589	14.9	317	-	-	-	-	-	-
-	-	-	-	33.6	500	-	-	-	-	-	-	-	-
38.4	500	38.4	500	-	-	24.3	317	24.3	317	19.7	256	-	-
-	-	-	-	36.8	400	-	-	-	-	-	-	-	-
48	400	48	400	48	400	38	317	38	317	30.7	256	-	-
-	-	-	-	47.1	310	-	-	-	-	-	-	-	-
58.1	310	-	-	58.1	310	59.4	317	59.4	317	48	256	68	364
83.7	310	-	-	83.7	310	85.6	317	-	-	-	-	79	256
-	-	-	-	-	-	-	-	-	-	-	-	72	151
-	-	-	-	-	-	-	-	-	-	-	-	93	124

Notes: The values stated in the table apply for 3 and 4 pole fixed mounted devices with an equal load distribution. On 4 pole devices the current in the neutral conductor is equal to zero. The total resistive load is the measured value for a 3 pole or a 4 pole switch (independent of I_n and the type of release).

The total resistive load for a switch or withdrawable plug results from: the resistive value for fixed mounting + resistive value for plug-in or withdrawable. The heat dissipation can be calculated with the formula: P = 3 x R x I²



17/176 Circuit-breakers, switch-disconnectors

Terminal capacities

NZM..., PN..., NS..., N...













				NZM1, PN1, N1, NS1 160 A	I _n ¹⁾ A	NZM2, PN2, N2, NS2 300 A	I _n ¹⁾ A	NZM3, PN3, N3, NS3 630 A	I _n ¹⁾ A
Terminal capacities									
Standard equipment				Box terminal	–	Screw terminal	–	Screw terminal	–
Accessories				Screw terminals Tunnel terminals Rear terminal bolts		Box terminal Tunnel terminals Rear terminal bolts		Box terminal Tunnel terminals Rear terminal bolts	
Copper conductors and cables									
Box terminal	Solid		mm ²	1 x (10 – 16) 2 x (6 – 16)	160	1 x (10 – 16) 2 x (4 – 16)	300	2 x 16	500
			mm ²	1 x (25 – 70) ³⁾ 2 x (6 – 25)		1 x (25 – 185) 2 x (25 – 70)		1 x (35 – 240) 2 x (25 – 120)	
Tunnel terminal	Solid		mm ²	1 x 16	160	1 x 16	300	–	–
			Stranded	1-hole	mm ²	1 x (25 – 95)	–	1 x (25 – 185)	–
	Double-hole	mm ²		–	–	–	–	1 x (50 – 240) 2 x (50 – 240)	630 2 x 185
	4-hole	mm ²	–	–	–	–	–	–	
Screw terminals and connection on rear									
Directly on switch	Solid		mm ²	1 x (10 – 16) 2 x (6 – 16)	160	1 x (10 – 16) 2 x (4 – 16)	300	1 x 16 2 x 16	630 2 x 185
			mm ²	1 x (25 – 70) ³⁾ 2 x 25		1 x (25 – 185) 2 x (25 – 70)		1 x (25 – 240) 2 x (25 – 240)	
Module plate	1-hole	min.	mm ²	–	–	–	–	–	–
		max.	mm ²	–	–	–	–	–	–
Module plate	2-hole	min.	mm ²	–	–	–	–	–	–
		max.	mm ²	–	–	–	–	–	–
Connection width extension			mm ²					2 x 300	630 2 x 185
Aluminium conductors and cables									
Tunnel terminal	Solid Stranded		mm ²	1 x 16	160	1 x 16	250	1 x 16	350
			1-hole	mm ²	1 x (25 – 95)	–	1 x (25 – 185)	–	1 x (25 – 185) ²⁾
			Double-hole	mm ²	–	–	–	1 x (50 – 240) 2 x (50 – 240)	630
			4-hole	mm ²	–	–	–	–	–
Screw terminals and connection on rear									
Directly on switch	Solid		mm ²	1 x (10 – 16) 2 x (10 – 16)	160	1 x (10 – 16) 2 x (10 – 16)	250	1 x 16 2 x (10 – 16)	400
			mm ²	1 x (25 – 35) 2 x (25 – 35)		1 x (25 – 50) 2 x (25 – 50)		1 x (25 – 120) 2 x (25 – 120)	
Module plate	1-hole	min.	mm ²	–	–	–	–	–	–
		max.	mm ²	–	–	–	–	–	–
Module plate	2-hole	min.	mm ²	–	–	–	–	–	–
		max.	mm ²	–	–	–	–	–	–
Connection width extension			mm ²						
Copper strip (number of segments x width x segment thickness)									
Box terminal		min.	mm	2 x 9 x 0.8	160	2 x 9 x 0.8	300	6 x 16 x 0.8	630
		max.	mm	9 x 9 x 0.8		10 x 16 x 0.8 (2 x) 8 x 15.5 x 0.8		10 x 24 x 1.0 + 5 x 24 x 1.0 (2 x) 8 x 24 x 1.0	
Single flat cable terminal		min.	mm	–	–	–	–	–	–
		max.	mm	–	–	–	–	–	–
Module plate	1-hole	min.	mm	–	–	–	–	–	–
		max.	mm	–	–	–	–	–	–
Screw terminals and connection on rear									
Copper strip, perforated		min.	mm	–	–	2 x 16 x 0.8	300	6 x 16 x 0.8	630
		max.	mm	–	–	10 x 24 x 0.8		10 x 32 x 1.0 + 5 x 32 x 1.0	
Connection width extension			mm ²					(2 x) 10 x 50 x 1.0	
Copper bar (width x thickness)									
Screw terminals and connection on rear									
Screw terminals				M6	–	M8	–	M10	–
			Directly on switch	min.	mm	12 x 5	160	16 x 5	300
			max.	mm	16 x 5		24 x 8		30 x 10 +30 x 5
Module plate	1-hole	min.	mm	–	–	–	–	–	–
		max.	mm	–	–	–	–	–	–
Module plate	2-hole	min.	mm	–	–	–	–	–	–
		max.	mm	–	–	–	–	–	–
Connection width extension			min.	mm	–	–	–	–	630
		max.	mm	–	–	–	–	2 x (10 x 50)	10 x 40

Notes

- ¹⁾ The rated currents I_n have been determined according to IEC/EN 60947 (switchgear standard) and generally relate to the max. defined cross-sections. They are given for general reference here. The engineering standards which apply in each case must be observed.
- ²⁾ To 240 mm² can be connected depending on the make of cable.
- ³⁾ To 95 mm² can be connected depending on the make of cable.

NZM4, N4, NS4 1600 A	I _n ¹⁾ A		NZM...1...NA, NS1...NA	NZM...2...NA, NS2...NA	NZM...3...NA, NS3...NA	NZM...4...NA, NS4...NA
Screw terminal	–	–	Box terminal	Screw terminal	Screw terminal	Screw terminal
Tunnel terminals	–	–	Screw terminals	Box terminal	Box terminal	Tunnel terminals
Rear terminal bolts	–	–	Tunnel terminals	Tunnel terminals	Tunnel terminals	Rear terminal bolts
Strip terminal	–	–	Rear terminal bolts	Rear terminal bolts	Rear terminal bolts	Strip terminal
–	–	AWG	1 x (12 – 6)	1 x (12 – 6)	–	–
–	–	AWG/kcmil	1 x (4 – 2/0)	1 x (4 – 350)	1 x (2 – 500)	–
–	–	AWG	1 x 6	1 x 6	1 x 6	–
–	–	AWG/kcmil	1 x (4 – 3/0)	1 x (4 – 350)	1 x (4 – 350)	–
–	–	AWG/kcmil	–	–	1 x (0 – 500) 2 x (0 – 500)	–
4 x (50 – 240)	1400	AWG/kcmil	–	–	–	4 x (0 – 500)
–	–	AWG	1 x (12 – 6) 2 x (9 – 6)	1 x (12 – 6)	–	–
1 x (120 – 185)	1250	AWG/kcmil	1 x (4 – 2/0)	1 x (4 – 3/0)	1 x (4 – 350) 2 x 350	1 x (250 – 350) 4 x (0 – 350)
4 x (50 – 185)	–	kcmil	–	–	–	1 x (250 – 600)
1 x (120 – 300)	1000	AWG/kcmil	–	–	–	2 x (3/0 – 600)
2 x (95 – 300)	–	AWG/kcmil	–	–	–	2 x (3/0 – 350)
2 x (95 – 185)	1400	AWG/kcmil	–	–	–	4 x (2 – 350)
4 x (35 – 185)	–	AWG/kcmil	–	–	–	4 x 600 6 x (3/0 – 500)
4 x 300	1600	AWG/kcmil	–	–	2 x 500	–
6 x (95 – 240)	4 x 240	–	–	–	–	–
–	–	AWG	–	–	–	–
–	–	AWG/kcmil	–	–	–	–
–	–	AWG/kcmil	–	–	–	–
4 x (50 – 240)	1400	AWG/kcmil	–	–	–	–
–	–	AWG	–	–	–	–
–	–	AWG/kcmil	–	–	–	–
1 x (185 – 240)	Please inquire	kcmil	–	–	–	–
2 x (70 – 185)	Please inquire	AWG/kcmil	–	–	–	–
4 x 50	–	AWG	–	–	–	–
2 x 240	Please inquire	AWG/kcmil	–	–	–	–
6 x (70 – 240)	–	–	–	–	–	–
–	–	mm	2 x 9 x 0.8	2 x 9 x 0.8	6 x 16 x 0.8	–
–	–	mm	9 x 9 x 0.8	10 x 16 x 0.8	10 x 24 x 1.0 + 5 x 24 x 1.0 (2 x) 8 x 24 x 1.0	–
6 x 16 x 0.8	1100	mm	–	–	–	6 x 16 x 0.8
(2 x) 10 x 32 x 1.0	–	mm	–	–	–	(2 x) 10 x 32 x 1.0
(2 x) 10 x 50 x 1.0	1250 (2 x) 10 x 40 x 1.0	mm	–	–	–	(2 x) 10 x 50 x 1.0
(2 x) 10 x 50 x 1.0	1600	mm	–	2 x 16 x 0.8	6 x 16 x 0.8	(2 x) 10 x 50 x 1.0
(2 x) 10 x 50 x 1.0	–	mm	–	10 x 16 x 0.8	10 x 32 x 1.0 + 5 x 32 x 1.0	(2 x) 10 x 50 x 1.0
(2 x) 10 x 80 x 1.0	1600 2 x (10 x 50 x 1.0)	mm	–	–	(2 x) 10 x 50 x 1.0	(2 x) 10 x 80 x 1.0
M10	–	–	M6	M8	M10	M10
25 x 5	1600	mm	12 x 5	16 x 5	20 x 5	25 x 5
2 x (50 x 10)	–	mm	16 x 5	20 x 5	30 x 10 +30 x 5	2 x (50 x 10)
2 x (80 x 10)	–	mm	–	–	–	25 x 5
25 x 5	1250	mm	–	–	–	2 x (50 x 10)
2 x (50 x 10)	2 x (40 x 10)	mm	–	–	–	2 x (50 x 10)
2 x (50 x 10)	1600	mm	–	–	–	60 x 10
60 x 10	1600	mm	–	–	–	2 x (80 x 10)
2 x (80 x 10)	2 x (50 x 10)	mm	–	–	2 x (10 x 50)	–



Basic devices	Jumper kits	Reduction of the rated operational current (derating) under particular ambient conditions										
		Contact protection	Mounting position	Temperature compensation coefficient							60 °C	65 °C
				20 °C	30 °C	40 °C	50 °C	55 °C	60 °C	65 °C	70 °C	
Switch-disconnectors												
N2-4-160-S1-DC		+NZM2-4-XKV2P	IP2X	v	1	1	1	1	1	1	1	1
				h	1	1	1	1	1	1	1	1
N2-4-200-S1-DC		+NZM2-4-XKV2P	IP2X	v	1	1	1	1	1	1	1	0.95
				h	1	1	1	1	1	1	0.95	0.92
N3-4-320(400)-S1-DC		+NZM3-4-XKV2P	IP2X	v	1	1	1	1	1	1	1	1
				h	1	1	1	1	1	1	1	1
		+NZM3-4-XKV12P	IP00	v	1	1	1	1	1	1	1	1
				h	1	1	1	1	1	1	1	1
N3-4-500-S1-DC		+NZM3-4-XKV12P-K	IP00	v	1	1	1	1	1	1	1	0.97
				h	1	1	1	1	1	1	0.97	0.95
		+NZM3-4-XKV12P	IP00	v	1	1	1	0.97	0.95	0.92	0.89	
				h	1	1	1	0.97	0.95	0.92	0.89	
		+NZM3-4-XKV2P-K	IP1X	v	1	1	1	1	1	0.98	0.95	0.92
				h	1	1	1	1	0.97	0.94	0.91	0.89
		+NZM3-4-XKV2P-K	IP2X	v	1	1	1	0.95	0.92	0.89	0.86	0.83
				h	1	1	0.98	0.93	0.9	0.87	0.84	0.81
N4-4-800(1000)-S1-DC		+NZM4-4-XKV2P	IP2X	v	1	1	1	1	1	1	1	1
				h	1	1	1	1	1	1	1	1
N4-4-1250-S1-DC		+NZM4-4-XKV2P	IP2X	v	1	1	1	1	1	1	1	0.97
				h	1	1	1	1	1	1	0.97	0.95
N4-4-1400-S1-DC		+NZM4-4-XKV2P	IP2X	v	1	1		0.94	0.92	0.9	–	–
				h	1	1	0.97	0.91	–	–	–	–
		+NZM3-4-XKV2P-1400	IP00	v	1	1	1	1	1 ¹⁾	1 ¹⁾	1 ¹⁾	0.97
				h	1	1	1	1	1 ¹⁾	1 ¹⁾	1 ¹⁾	0.97

Notes

Mounting position:

v = vertical, h = horizontal

Incomer and outgoing at bottom or top, freely selectable.

¹⁾ Incomer at from bottom only.



At AC = 50/60 Hz				M22-K...	M22-CK...	XHIV
Auxiliary contacts						
Rated operating voltage						
AC voltage	U_e	V AC	500	230	500	
DC voltage	U_e	V DC	220	220	220	
Conventional thermal current	$I_{th} = I_e$	A	4	4	4	
Rated operational current						
AC-15	115 V	I_e	A	4	4	4
	230 V	I_e	A	4	4	4
	400 V	I_e	A	2	–	2
	500 V	I_e	A	1	–	1
DC-13	24 V	I_e	A	3	3	3
	42 V	I_e	A	1.7	1	1.5
	60 V	I_e	A	1.2	0.8	0.8
	110 V	I_e	A	0.8	0.5	0.5
	220 V	I_e	A	0.3	0.2	0.2
Short-circuit protection						
Max. fuse		A gG/gL	10	10	10	
Max. miniature circuit-breaker		A	PKZM0-10/FAZ-B6	FAZ-B6/B1	FAZ-B6	
Early make times compared to main contacts on make and break (switching times on manual operation).			ms	–	–	NZM1, PN1, N(S)1: approx. 20 NZM2, PN2, N(S)2: approx. 20 NZM3, PN3, N(S)3: approx. 20 NZM4, N(S)4: approx. 90 With NZM4/N(S)4 the HIV does not feature early break.
Terminal capacities						
Solid or flexible conductor with ferrule		mm ²	1 x (0.75 – 2.5) 2 x (0.75 – 2.5)	1 x (0.5 – 1.5) 2 x (0.5 – 0.75)	1 x (0.75 – 2.5) 2 x (0.75 – 2.5)	
		AWG	1 x (18 – 14) 2 x (18 – 14)	1 x (20 – 18) 2 x (20 – 18)	1 x (18 – 14) 2 x (18 – 14)	
UL/CSA						
Rated operational current	I_e	A	10 A ... 600 V AC 1 A – 250 V DC		2.5 A – 240 V AC 1 A – 250 V DC	
Heavy Pilot Duty			A600/P300 via 300 V AC same polarity		C300/R300	

Maximum equipment and position of the built-in accessories

③
-XHIV(2S)
or -XA
or -XU

②
HIA

①
HIN

	NZM1, N(S)1	1	1	1
	NZM2, N(S)2	1	1	2
	NZM3, N(S)3	1	1	3
	NZM4, N(S)4	1	2	3
	PN1	1	–	1
	PN2	1	–	2
	PN3	1	–	3

Time differences ON-OFF

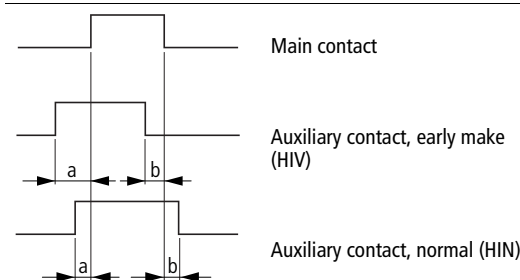

Notes

On combination with remote operator NZM-XR..., the right slot for standard auxiliary contacts HIN can be equipped only with single contacts.

	Time difference a (ms)						Time difference b (ms)					
	Manual operation			Motor drive			Manual operation			Motor drive		
	HIV	HIN	K01	HIV	HIN	K01	HIV	HIN	K01	HIV	HIN	K01
NZM1	20 ²⁾	0	2.5	–	–	–	20 ²⁾	0	2.5	–	–	–
NZM2	20 ²⁾	3.5	6.5	Not permissible	2.5	4.5	20 ²⁾	3	4.5	Not permissible	3	4
NZM3	20 ²⁾	4	8	Not permissible	2	4	20 ²⁾	3.5	8	Not permissible	3	6.5
NZM4	90 ²⁾	7	11	Not permissible	Please inquire	Please inquire	0 ¹⁾²⁾	12	15	Not permissible	Please inquire	Please inquire

Notes

¹⁾ With NZM4/N(S)4 the HIV does **not** feature early break.
²⁾ Minimum value, as it is dependent on the switching speed.

17/180 Circuit-breakers, switch-disconnectors

Undervoltage releases, shunt releases, capacitor unit

NZM...-XU, NZM...-XA...

			NZM1(2/3)-XU...	NZM4-XU...
Undervoltage releases				
Rated control voltage				
AC voltage at 50/60 Hz	U_s	V AC	24...600	24...600
DC voltage	U_s	V DC	12...250	12...250
Operating range				
Drop-out voltage		$x U_s$	0.35 – 0.7	0.35 – 0.7
Pick-up voltage		$x U_s$	0.85 – 1.1	0.85 – 1.1
Power consumption				
AC voltage				
AC pick-up rating		VA	1.5	3.6
AC consumption when closed		VA	1.5	3.6
DC voltage				
DC pick-up rating		W	0.8	2.5
DC consumption when closed		W	0.8	2.5
Max. opening delay (response time until the main circuits open)		ms	19	23
Minimum signal duration		ms	10 – 15	10 – 15
Terminal capacities				
Solid or flexible conductor with ferrule		mm ²	1 x (0.75 – 2.5) 2 x (0.75 – 2.5)	1 x (0.75 – 2.5) 2 x (0.75 – 2.5)
		AWG	1 x (18 – 14) 2 x (18 – 14)	1 x (18 – 14) 2 x (18 – 14)

			UVU-NZM
Undervoltage releases, off-delayed			
Rated operating voltage			
AC voltage at 50/60 Hz	U_e	V AC	24, 220 – 550
DC voltage	U_e	V DC	24
Inrush current (peak value)	I_e	mA	< 500
Power consumption		VA	50
Deceleration time	t_{sd}	ms	70 – 4000
With additional external capacitor 90,000 μ F \geq 35 V		s	To 16
With additional external capacitor 30,000 μ F \geq 35 V		s	To 8
Terminal capacities			
Solid or flexible conductor with ferrule		mm ²	1 x (0.5 – 2.5) 2 x (0.5 – 1.5)

			NZM-XCM
Capacitor unit for shunt release			
Rated operating voltage	U_e	V AC	
Rated operational current	I_e	mA	
Inrush current (peak value)	I_e	A	
Terminal capacity			
Solid or flexible conductor with ferrule		mm ²	1 x (0.5 – 2.5)
		AWG	1 x (20 – 14)
		G	2 x (20 – 16)

			NZM1(2/3)-XA...	NZM4-XA...	NZM2/3-XA...-MNS	NZM4-XA...-MNS
Shunt releases (for power circuit breaker)						
Rated control voltage						
AC voltage	U_s	V AC	12...440	12...440	230	230
DC voltage	U_s	V DC	12...440	12...440	–	–
Frequency range		Hz	0 – 400	0 – 400	50/60	50/60
Operating range						
AC voltage		$x U_s$	0.7...1.1	0.7...1.1	0.1...1.1	0.1...1.1
DC voltage		$x U_s$	0.7...1.1	0.7...1.1	–	–
Power consumption						
AC/DC pick-up rating		VA/W	2.5	2.5	–	–
AC/DC consumption when closed		VA/W	2.5	2.5	–	–
Maximum power consumption at 110 % U_s (230 V 50 Hz)		A	–	–	0.5	1
Max. opening delay (response time until the main circuits open)		ms	20	22	20	22
Max. duty factor		ms	∞	∞	1000 ms	1000 ms
Minimum signal duration		ms	10 – 15	10 – 15	10 – 15	10 – 15
Terminal capacity						
Solid or flexible conductor with ferrule		mm ²	1 x (0.75 – 2.5) 2 x (0.75 – 2.5)	1 x (0.75 – 2.5) 2 x (0.75 – 2.5)	1 x (0.75 – 2.5) 2 x (0.75 – 2.5)	1 x (0.75 – 2.5) 2 x (0.75 – 2.5)
		AWG	1 x (18 – 14) 2 x (18 – 14)	1 x (18 – 14) 2 x (18 – 14)	1 x (18 – 14) 2 x (18 – 14)	1 x (18 – 14) 2 x (18 – 14)



			NZM2-XRD...	NZM2-XR...	NZM3-XR...	NZM4-XR...
Remote operators						
Rated control voltage						
AC voltage	U_s	V AC	100...440	110...440	110...440	110...440
DC voltage	U_s	V DC	24...250	24...250	24...250	24...250
Operating range						
AC voltage	U_s		0.85...1.1	0.85...1.1	0.85...1.1	0.85...1.1
DC voltage	U_s		0.85...1.1	0.85...1.1	0.85...1.1	0.85...1.1
Rated operational power						
AC voltage	110 V ... 130 V AC	VA	550	350	350	350
	208 V ... 240 V AC	VA	550	350	350	350
	380 V ... 440 V AC	VA	650	350	350	350
DC voltage	24 V ... 30 V DC	W	450	250 (max. 17A 30 ms)	250	250
	110 V ... 130 V DC	W	450	250	250	250
	220 V ... 250 V DC	W	450	250	250	250
Total make time		ms	110-170	60	80	100
Total opening delay		ms	110-170	300	1000	3000
Minimum signal duration						
With switch on		ms	100	30	30	30
With switch off		ms	100	150	250	500
Lifespan, mechanical	Operations		20000	20000	15000	10000
Maximum operating frequency		Ops/h	120	120	60	20
Terminal capacities						
Solid or flexible conductor with ferrule		mm ²	0.75 – 2.5	0.75 – 2.5	0.75 – 2.5	0.75 – 2.5
		AWG	18 – 14	18 – 14	18 – 14	18 – 14

			PFR-003	PFR-03	PFR-5
Electrical					
Standards			IEC/EN 60947-2, IEC 755, IEC 1008, IEC 1009		
Sensitivity			Pulse-current sensitive, type A		
Rated control voltage	U_s	V AC	230 ±20% (50/60 Hz)		
Motor rating	P_e	W	3	3	3
Rated fault currents	$I_{\Delta n}$	A	0.03	0.3	0.03, 0.1, 0.3, 0.5, 1, 3, 5
Deceleration time	t_d	s	0.02 (non-delayed)	0.02 (non-delayed)	0.02, 0.1, 0.3, 0.5, 1, 3, 5
Relay contacts			1 built-in changeover contact	1 built-in changeover contact	1 built-in changeover contact
Rated operating voltage of the relay contacts		V AC/DC	250/100	250/100	250/100
Rated operational current of the relay contacts		A	6	6	6
Fault current early warning		Hz	–	–	0.5 = 25% – 50% $I_{\Delta n}$ 1 = 50% – 75% $I_{\Delta n}$ 2 = 75% – 100% $I_{\Delta n}$
Mechanical					
Standard front dimension		mm	45	45	45
Device height		mm	85	85	85
Built-in width		mm	36	36	36
Mounting			Quick attachment for top-hat rail DIN 46277, EN 50022		
Terminals top and bottom			Box terminals		
Terminal protection			Finger and back-of-hand proof BGV A2, VDE 106 Part 100		
Terminal capacities		mm ²	2 x 0.75 – 2.5 solid, 2 x 0.75 – 1.5 flexible/with sleeve		
Sealing facility for setting buttons			–	–	Yes



17/182 Circuit-breakers, switch-disconnectors

Earth-fault releases

NZM...-XFI...

			NZM1(-4)-XFI30R NZM1(-4)-XFI300R NZM1(-4)-XFIR	NZM1(-4)-XFI30U NZM1(-4)-XFI300U NZM1(-4)-XFIU	+NZM2-4-XFI30 +NZM2-4-XFI	+NZM2-4-XFIA30 +NZM2-4-XFIA NZMH2...-XFIA30
Electrical						
Standards			IEC/EN 60947-2			
Sensitivity			Pulse-current sensitive, type A			
Min. operating voltage						
For detecting type A/AC fault currents			80 V (dependent on mains power)	80 V (dependent on mains power)	0 V (independent of mains power)	0 V (independent of mains power)
For detecting type B fault currents			–	–	–	50 V (dependent on mains power)
Suitable for use in			Three- and single-phase systems	Three-phase systems	Three- and single-phase systems	Three- and single-phase systems
Rated operating voltage	U_e	V AC	200...415 (3~)	200...415 (3~)	280...690	50...400 (3~)
Rated frequency	f	Hz	50/60	50/60	50/60	50/60
Number of poles			3/4	3/4	3/4	3/4
Rated operational current range	I_n	A	15...160	15...100	15...250	15...250
Rated fault currents	$I_{\Delta n}$	A				
NZM1(-4)-XFI30R			0.03			
NZM1(-4)-XFI300R			0.3			
NZM1(-4)-XFIR			0.03-0.1-0.3-0.5-1-3			
NZM1(-4)-XFI30U				0.03		
NZM1(-4)-XFI300U				0.3		
NZM1(-4)-XFIU				0.03-0.1-0.3-0.5-1-3		
+NZM2-4-XFI30					0.03	
+NZM2-4-XFI					0.1-0.3-1-3	
+NZM2-4-XFIA30						0.03
+NZM2-4-XFIA						0.3-1
NZMH2...-XFIA30						0.03
Detection range of fault current			50/60 Hz	50/60 Hz	50/60 Hz	With AC voltage: 0 – 100 kHz With pulsed DC voltage: 50 Hz
Rated ultimate short-circuit making and rated breaking capacity	$I_{\Delta m}$	A	= I_{CU}	= I_{CU}	= I_{CU}	= I_{CU}
Fault current early warning			$\geq 0.3 \times I_{\Delta n}$	$\geq 0.3 \times I_{\Delta n}$	–	–
Shock resistance (IEC 60068-2-27)			20 (half-sinusoidal shock 20 ms)			
Lifespan, mechanical (50 % with fault current)	Operations		20000	20000	≥ 2000	≥ 2000 NZMH2: 20000
Mechanical						
Standard front dimension		mm	45	45	96	96
Mounting			On right side	Bottom	Bottom	Bottom
Mounting position			Vertical and 90° in all directions			
Feeder			NZM1 from above	NZM1 from above	Any	Bottom
Degree of protection			IP20 in the operating component area			
Ambient temperature		°C	–5...+40	–5...+40	–25...+70	–25...+70
Terminal capacities						
Flexible without ferrule		mm ²	Same as NZM1 standard terminal			
Flexible with ferrule		mm ²	Same as NZM1 standard terminal			
Sealability			Yes, setting buttons			



			DMI
General			
Dimensions (W x H x D)		mm	107.5 x 90 x 53
Modular spacing (space units)			6 SU (space units) wide
Weight		kg	0.3
Mounting			Top-hat rail IEC/EN 60715, 35 mm
Ambient climatic conditions			
Operating ambient temperature		°C	0 to +55
Built-in position			Horizontal/vertical
Condensation			Prevent condensation by means of suitable measures
LCD display (clearly legible)		°C	0 to +55
Storage/transport		°C	-40 to +70
Relative humidity, non-condensing (IEC/EN 60068-2-30)		%	5...95
Air pressure (in operation)		hPa	795...1080
Corrosion resistance			
IEC/EN 60068-2-42	4 days SO ₂	cm ³ /m ³	10
IEC/EN 60068-2-43	4 days H ₂ S	cm ³ /m ³	1
Ambient mechanical conditions			
Pollution degree			2
Degree of protection IEC/EN 60529			IP20
Vibrations (IEC/EN 60068-2-6)			
Constant amplitude 0.15 mm		Hz	10...57
Constant acceleration, 2 g		Hz	57...150
Mechanical shock resistance (IEC/EN 60068-2-27) semi-sinusoidal 15 g/11			
Drop IEC/EN 60068-2-31	Drop height	mm	50
Free fall, packaged (IEC/EN 60068-2-32)		m	1
Power supply			
Rated operating voltage	U _e	V DC	24
Permissible range		V DC	20.4...28.8
Residual ripple		%	≤ 5
Input current at 24 V DC		mA	210
Voltage dips (IEC/EN 61131-2)		ms	10
Power loss at 24 V DC		W	5



17/184 Circuit-breakers, switch-disconnectors

Fieldbus interface

EASY22..., NZM-XDMI

			EASY221-C0	EASY222-DN	NZM-XDMI-DPV1
General					
Standards			EN 55011, EN 55022, EN 61000-4, IEC 60068-2-6, IEC 60068-2-27		
Dimensions (W x H x D)		mm	35.5 x 90 x 58 (2 space units)	35.5 x 90 x 58 (2 space units)	35.5 x 90 x 58 (2 space units)
Weight		kg	0.15	0.15	0.15
Mounting			Top-hat rail EN 50022, 35 mm or screw fixing using fixing brackets ZB4-101-GF1 (accessories)		
Terminal capacity					
Solid		mm ²	0.2x4 (AWG 22 – 12)	0.2x4 (AWG 22 – 12)	0.2x4 (AWG 22 – 12)
Flexible with ferrule		mm ²	0.2x2.5 (AWG 22 – 12)	0.2x2.5 (AWG 22 – 12)	0.2x2.5 (AWG 22 – 12)
Standard screwdriver		mm	3.5 x 0.8	3.5 x 0.8	3.5 x 0.8
Max. tightening torque		Nm	0.6	0.6	0.6
Ambient climatic conditions					
Operating ambient temperature		°C	-25 to 55, low temperatures to IEC 60068-2-1, high temperatures to IEC 60068-2-2		
Condensation			Prevent condensation by means of suitable measures		
Storage		°C	40 – 70	40 – 70	40 – 70
Relative humidity, non-condensing (IEC/EN 60068-2-30)		%	5 – 95	5 – 95	5 – 95
Air pressure (in operation)		hPa	795 – 1080	795 – 1080	795 – 1080
Corrosion resistance					
IEC/EN 60068-2-42	4 days SO ₂	cm ³ /m ³	10	10	10
IEC/EN 60068-2-43	4 days H ₂ S	cm ³ /m ³	1	1	1
Ambient mechanical conditions					
Pollution degree			2	2	2
Degree of protection (IEC/EN 60529)			IP20	IP20	IP20
Vibrations (IEC/EN 60068-2-6)					
Constant amplitude 0.15 mm		Hz	10 – 57	10 – 57	10 – 57
Constant acceleration, 2 g		Hz	57 – 150	57 – 150	57 – 150
Mechanical shock resistance (IEC/EN 60068-2-27) semi-sinusoidal 15 g/11 ms		Shocks	18	18	18
Drop (IEC/EN 60 068-2-31)	Drop height	mm	50	50	50
Free fall, packaged (IEC/EN 60068-2-32)		m	1	1	1
Mounting position			horizontal x vertical	horizontal x vertical	horizontal x vertical
Electromagnetic compatibility (EMC)					
Electrostatic discharge (IEC/EN 61000-4-2, Level 3, ESD)					
Air discharge		kV	8	8	8
Contact discharge		kV	6	6	6
Electromagnetic fields (IEC/EN 61000-4-3, RFI)		V/m	10	10	10
Radio interference suppression (EN 55011)			EN 55011 Class B EN 55022 Class B		EN 55011 Class A EN 55022 Class A
Burst impulse (IEC/EN 61000-4-4, Level 3)					
Supply cables		kV	2	2	2
Signal cables		kV	2	2	2
High-energy pulses (surge) (IEC/EN 61000-4-5, Level 2)		kV	0.5 (supply cables, symmetrical)		
Immunity to line-conducted interference (IEC/EN 61000-4-6)		V	10	10	10

			EASY221-CO	EASY222-DN	NZM-XDMI-DPV1
Insulation resistance					
Clearances and creepage distances			EN 50178, UL 508, CSA C22.2, No. 142		
Insulation resistance			EN 50178		
Power supply					
Rated operating voltage	U_e	V	24 (-15/+20 %)	24 (-15/+20 %)	24 (-15/+20 %)
Permissible range		V DC	20.4 – 28.8	20.4 – 28.8	20.4 – 28.8
Ripple		%	< 5	< 5	< 5
At 24 V DC		mA	typ. 200	typ. 200	typ. 200
Voltage dips (IEC/EN 61131-2)		ms	10	10	10
Heat dissipation at 24 V DC		W	4.8	4.8	4.8
Polarity reversal protection					
Power supply			Yes	Yes	Yes
LED indicators					
Power supply			RUN LED (RUN): green	Module status LED (MS): green	Power LED (POW): green
LED display			LED ERROR (ERR): red	Network status LED (NS): red/green	PROFIBUS-DP LED (BUS): red
Network					
Terminal type			RJ45	5 pole, pluggable screw terminal	SUB-D 9 pole, socket
Potential isolation			Between bus and power supply (simple), between bus and power supply and NZM-XDMI612 (safe isolation)	Between bus and power supply (simple), between bus and power supply and NZM-XDMI612 (safe isolation)	Between bus and power supply (simple), between bus and power supply and NZM-XDMI612
Function			CANopen slave	DeviceNet slave	PROFIBUS-DP slave
Interface			CAN	CAN	RS 485
Bus protocol			CANopen	DeviceNet	PROFIBUS-DP
Baud rates			Automatic search up to 1 MBit/s	Automatic search up to 500 kBit/s	Automatic search up to 12 MBit/s
Bus terminating resistors			Separate external bus termination required (120 Ω) NZM-XDMI612	Separate external bus termination required (120 Ω) NZM-XDMI612	Separate external bus termination required
Bus addresses			1 – 127 addressed via display	0 – 63 addressed via display	1 – 126 via DMI
Services					
Cyclical			All data R1 – R16, S1 – S8	All data R1 – R16, S1 – S8	Status On/Off, tripped (detailed), load early warnings, phase currents $I_1/I_2/I_3$ [A], remote operator actuation, display/operation NZM-XDMI612, inputs/outputs, motor starter functions
Acyclical			Read/write, real-time, day, summer/winter time, all parameters of the easy function relay	Read/write, real-time, day, summer/winter time, all parameters of the easy function relay	Display/match protection protection settings, event list, identification, hours of operation, switching operations, time



				NZM-XSWD-704
General				
Standards				IEC/EN 61131-2 EN 50178
Dimensions (W x H x D)		mm		35 x 90 x 101
Weight		kg		0.1
Mounting				Top-hat rail IEC/EN 60715, 35 mm
Built-in position				Vertical
Ambient mechanical conditions				
Degree of protection (IEC/EN 60529)				IP20
Vibrations (IEC/EN 61131-2:2008)				
Constant amplitude 3.5 mm		Hz		5 ... 8.4
Constant acceleration, 1 g		Hz		8.4 ... 150
Mechanical shock resistance (IEC/EN 60068-2-27) semi-sinusoidal 15 g/11 ms				
		Shocks		9
Drop (IEC/EN 60068-2-31)	Drop height	mm		50
Free fall, packaged (IEC/EN 60068-2-32)		m		0.3
Electromagnetic compatibility (EMC)				
Overvoltage category				II
Pollution degree				2
Electrostatic discharge (IEC/EN 61131-2:2008)				
Air discharge (Level 3)		kV		8
Contact discharge (Level 2)		kV		4
Electromagnetic fields (IEC/EN 61131-2:2008)				
80 -1000 MHz		V/m		10
1.4-2 GHz		V/m		3
2-2.7 GHz		V/m		1
Radio interference suppression (SmartWire-Darwin)				
Burst (IEC/EN 61131-2:2008, Level 3)				EN 55011 Class A
Supply cables				
Supply cables		kV		2
Signal cables		kV		1
SmartWire-Darwin cables		kV		1
Surge (IEC/EN 61131-2:2008, Level 1)				
				–
Radiated RFI (IEC/EN 61131-2:2008, Level 3)				
		V		10
Ambient climatic conditions				
Operating ambient temperature (IEC 60068-2)				
		°C		–25 ... +55
Condensation				
				Prevent with suitable measures
Storage				
		°C		–40 ... 70
Relative humidity, non-condensing (IEC/EN 60068-2-30)				
		%		5 ... 95
SmartWire-Darwin interface				
Station type				
				SmartWire-Darwin station (slave)
Baud rate setting				
				Automatic
SmartWire-Darwin status				
		LED		Green
Connection				
				8-pin connector Connection plug: External device plug SWD4-8SF2-5
Power consumption (15 V SWD supply)				
				See separate table
Supply and I/O connection				
Connection type				
				Push-In
Solid				
		mm ²		0.2-1.5 (AWG 24-16)
Flexible with ferrule ¹⁾				
		mm ²		0.25-1.5
24 V DC supply for output supply				
Rated operating voltage				
	U _e	V		–
Input voltage residual ripple				
		%		–
Polarity reversal protection reversal				
				–

Notes¹⁾ Minimum length 8 mm.

			NZM-XSWD-704
Digital inputs			
Number			2
Input current		mA	Typically 4 at 24 V DC
Voltage level to IEC/EN 61131-2			
Limit value type 1			Low < 5 V DC; High > 15 V DC
Input delay			High → Low typically < 0.2 ms Low → High typically < 0.2 ms
Status display inputs		LED	Yellow
Digital semiconductor outputs			
Number			2
Output current		A	0.2 at 24 V DC
Short-circuit tripping current		A	–
Lamp load	R _{LL}	W	–
Overload proof			Yes, with diagnostics
Switching capacity			EN 60947-5-1 utilization category DC-13
Relay outputs			
Number			–
Contact type			–
Operations			
Utilization category AC-1, 250 V, 6 A			–
Utilization category AC-15, 250 V, 3 A			–
Utilization category DC-13, 24 V, 1 A			–
Safe disconnection		V AC	–
Minimum load current		mA	–
Response/reset time		ms	–
Bounce duration		ms	–
Short-circuit protection			–
Status display outputs		LED	–
Potential isolation			
Inputs for SmartWire-Darwin			Yes
Semiconductor outputs to SmartWire-Darwin			Yes
Semiconductor outputs to inputs			–
Relays to SmartWire-Darwin			–
Relays to inputs			–
Relays to relays			–



17/188 SmartWire-Darwin
Measuring and communication module
NZM-...XMC

		NZM2-XMC-S0	NZM3-XMC-S0	NZM2/3-XMC-MB
General				
Dimensions	mm	209 × 91 × 132 (3 pole) 251 × 91 × 132 (4 pole)	209 × 91 × 132 (3 pole) 251 × 91 × 132 (4 pole)	209 × 91 × 132 (3 pole) 251 × 91 × 132 (4 pole)
Weight	g	850 (3 pole) 975 (4 pole)	850 (3 pole) 975 (4 pole)	850 (3 pole) 975 (4 pole)
Material characteristic		UL94-V0	UL94-V0	UL94-V0
Environmental conditions				
Operating temperature	°C	-15-+65	-15-+65	-15-+65
Storage temperature	°C	-40-+80	-40-+80	-40-+80
Humidity (non-condensed)	%	5-95	5-95	5-95
Maximum operating altitude	m	2000	2000	2000
IP protection class		IP 20	IP 20	IP 20
Supply				
Voltage	V DC	18 – 36	18 – 36	18 – 36
Maximum current	mA	200	200	200
Conductors		Phoenix Contact GMVSTBR 2.5-2-ST-7.62	Phoenix Contact GMVSTBR 2.5-2-ST-7.62	Phoenix Contact GMVSTBR 2.5-2-ST-7.62
Voltage measurement				
Rated operating voltage	V AC	690	690	690
Maximum surge voltage at 8/20 ms	kV	8	8	8
Maximum voltage	V AC	800	800	800
Surge impedance (impedance)	kohms	1	1	1
Frequency	Hz	45-65	45-65	45-65
Accuracy		0.4 % measured value +0.05 % FS	0.4 % measured value +0.05 % FS	0.4 % measured value +0.05 % FS
Overvoltage category according to EN61010		CAT IV (600 V)	CAT IV (600 V)	CAT IV (600 V)
Current measurement				
Rated operational current	A AC	300	500	300 (NZM2)/500 (NZM3)
Maximum current	A AC	350	740	30
Maximum current impulse 1s	kA	30	30	30
Frequency	Hz	45-200	45-200	45-200
Category EN61010		CAT IV-600 V	CAT IV-600 V	CAT IV-600 V
Power measurement				
Maximum power (per phase)	kWh	-	-	280
Accuracy		-	-	0.95 % measurement + 0.05 % FS
Accuracy, active power		Class 1 (IEC62053-21)	Class 1 (IEC62053-21)	Class 1 (IEC62053-21)
Accuracy, reactive energy		-	-	Class 2 (IEC62053-23)
Pulse output				
Output type		NPN-isolated transistor	NPN-isolated transistor	NPN-isolated transistor
VCE max	V	80	80	80
VCE sat	V	0.4	0.4	0.4
Ic max	mA	50	50	50
Ic recommended	mA	10	10	10
Isolation	kV	3	3	3
Max. switching frequency	Hz	2	2	4
Pulse width	ms	120	120	≥ 20
Pulse rate power	Pulses/kW h	15	7.5	
Digital output				
Type		-	-	
Maximum voltage	V	-	-	350
Maximum current	mA	-	-	120
Isolation	kV	-	-	2.5
Digital input				
Maximum voltage	V	-	-	50
VIHmax	V	-	-	3
MODBUS output-RS485				
Data rate	bit/s	-	-	9600, 19200, 38400, 56000, 57600
Stop bits		-	-	1, 2
Parity		-	-	None, odd, even
Isolation	kV	-	-	3
Output – display				
DC supply voltage	V DC	-	-	5
Maximum current	mA	-	-	180



Dimensions

Circuit-breakers

Switch-disconnectors

3 pole

- NZMB1
- NZMC1
- NZMN1
- NZMH1
- PN1
- N1
- NS1

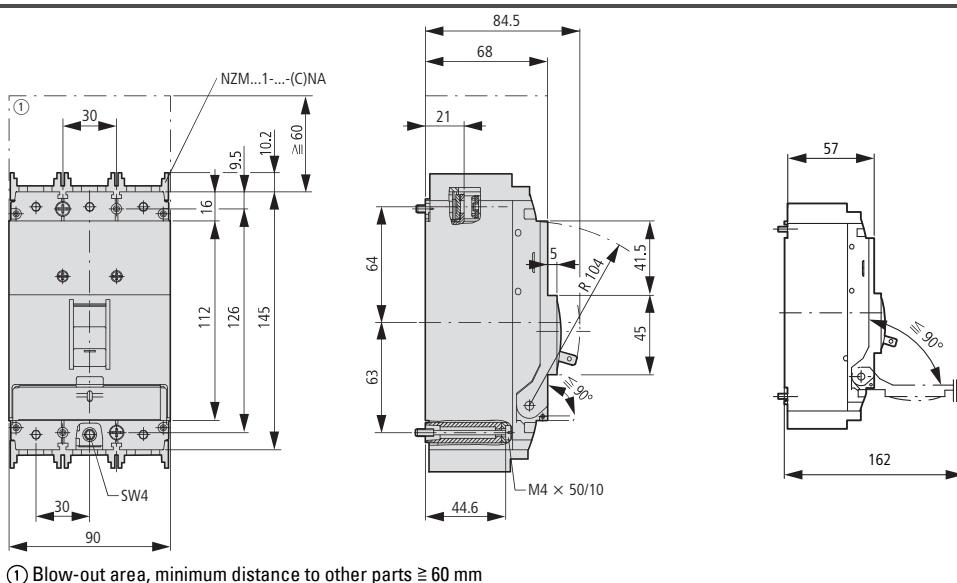

Circuit-breakers

Switch-disconnectors

4 pole

- NZMB1-4
- NZMC1-4
- NZMN1-4
- NZMH1-4
- PN1-4
- N1-4

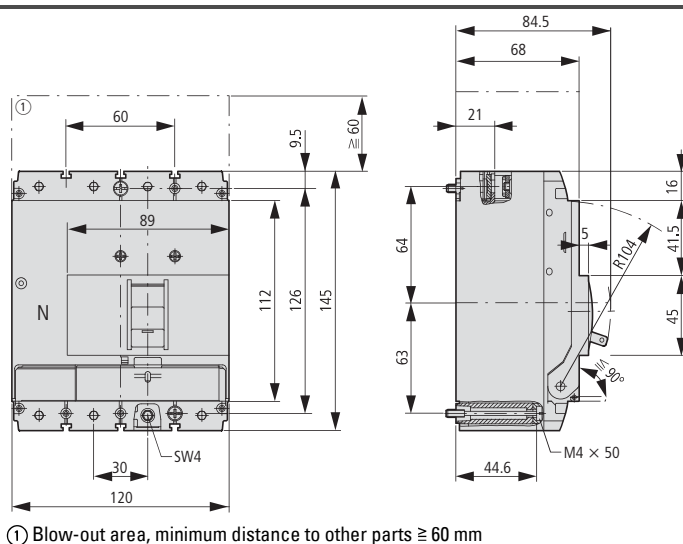

Covers

NZM1(-4)-XKSA

Screw terminals

NZM1(-4)-XKS

IP2X protection against contact with a finger for cover

NZM1(-4)-XIPA

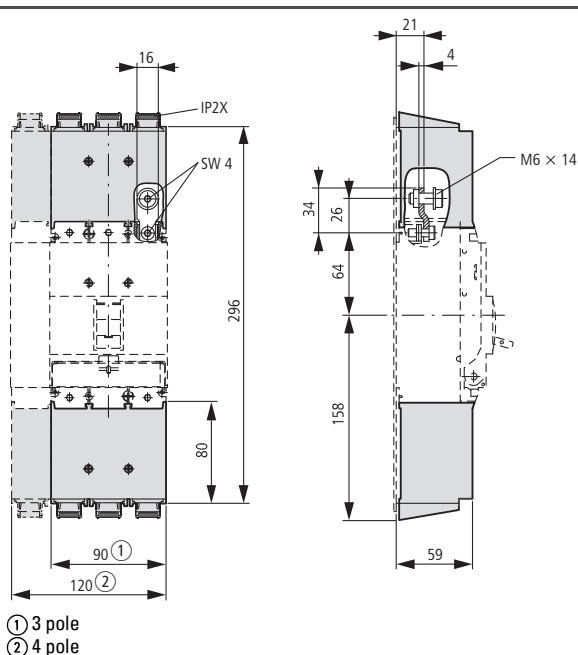

Switch-disconnectors

ATEX22-type

3 pole

PN1./ATEX22

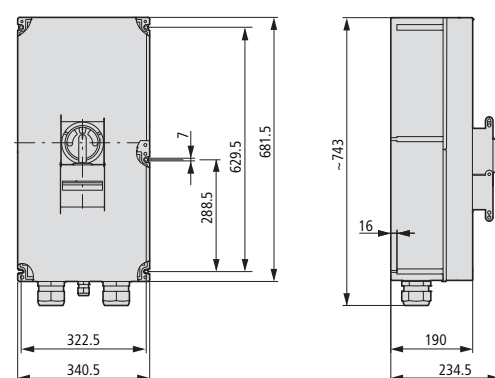

- ① 3 pole
- ② 4 pole

17/190 Circuit-breakers, switch-disconnectors

Construction size 1: accessories

NZM1...-XK..., NZM1...XIPK, NZM-XSTK

Tunnel terminal

NZM1(-4)-XKA

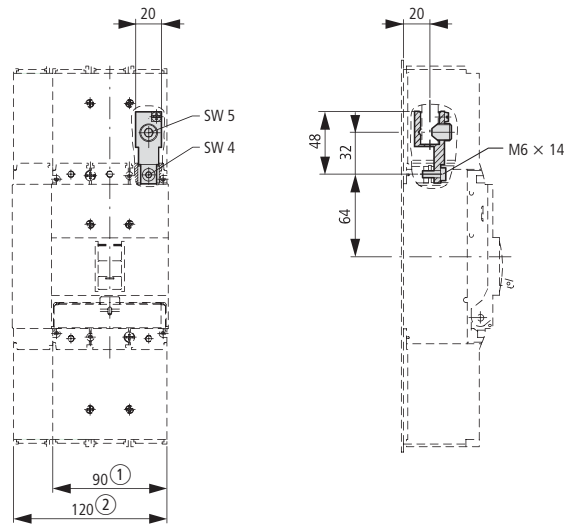

- ① 3 pole
- ② 4 pole

Rear terminal bolts

NZM1(4)-XKR

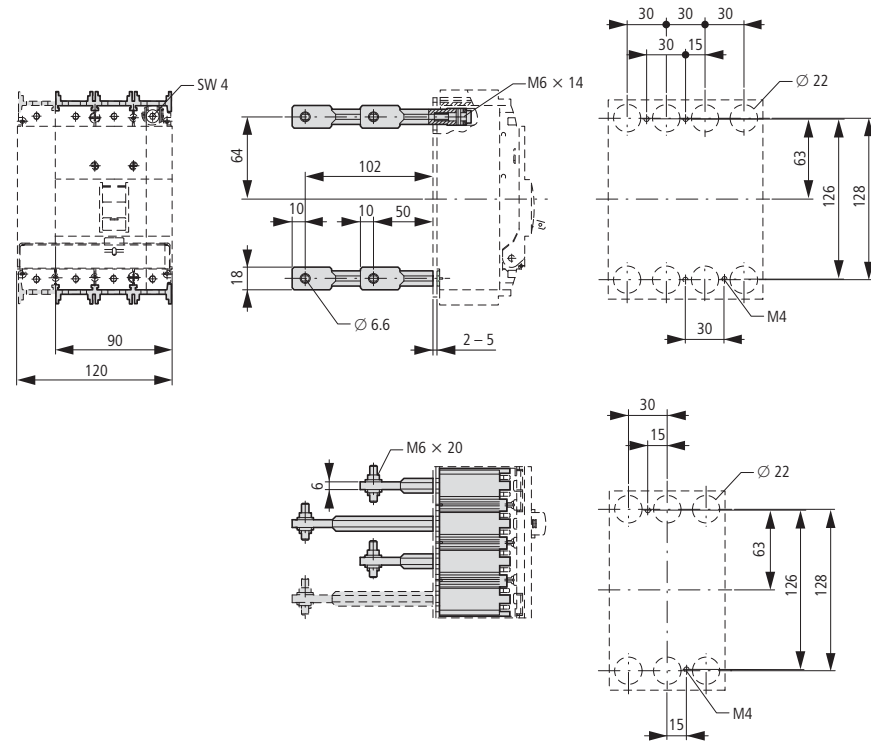

Control cable terminals

NZM1-XIPK, NZM-XSTK

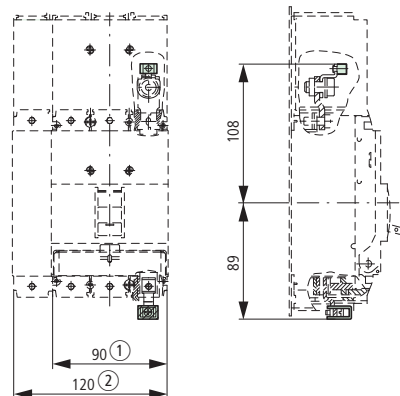

- ① 3 pole
- ② 4 pole

IP2X protection against contact with finger

NZM1(-4)-XIPK

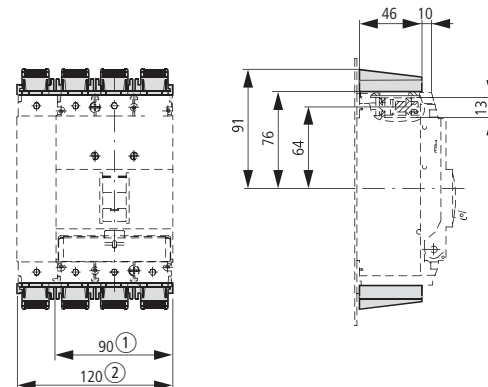

Rotary mechanism

Rotary handle on circuit-breaker

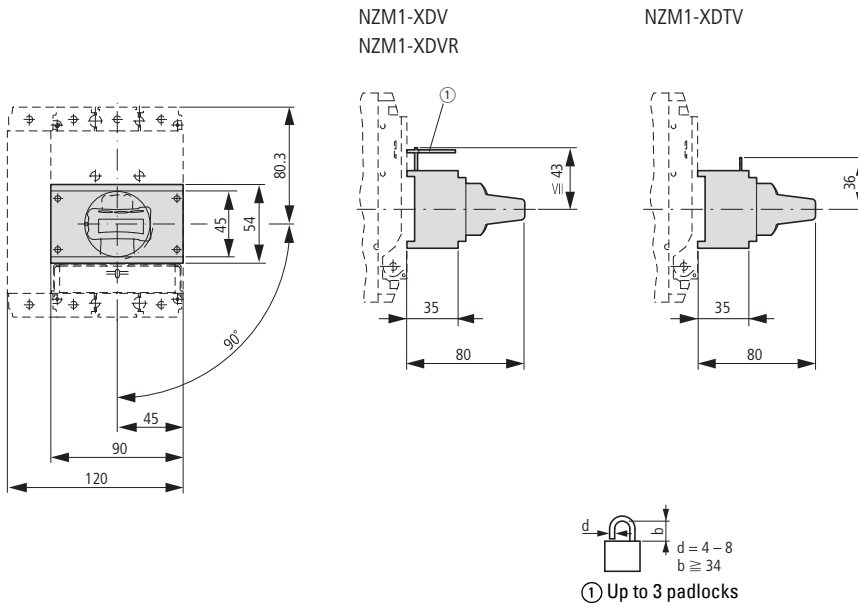

Door coupling rotary handles

NZM1-XTVD(V)(R)(-NA)

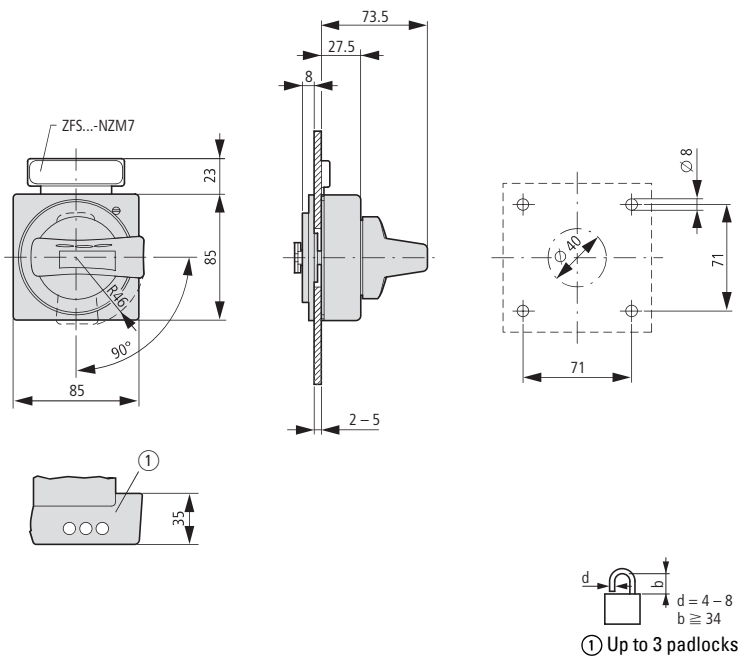

17/192 Circuit-breakers, switch-disconnectors

Construction size 1: accessories

NZM1-XTVD...

Door coupling rotary handle with extension shaft

NZM1-XTVD(V)(R)(-NA)
NZM1/2-XV4(6)

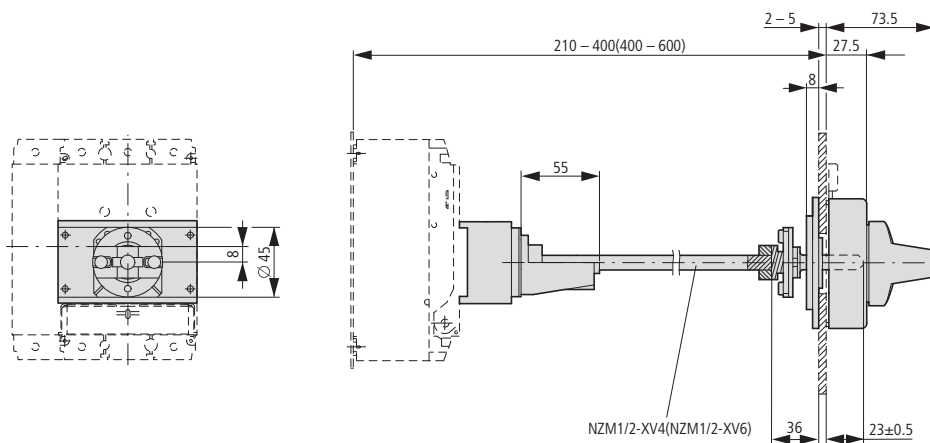

NZM1-XTVD(V)(R)-60(-NA)

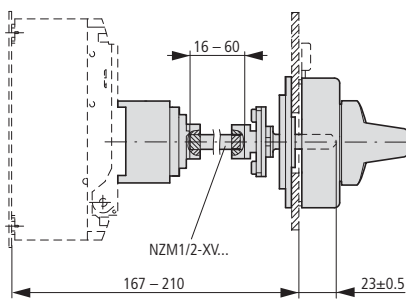

NZM1-XTVD(V)(R)-0(-NA)

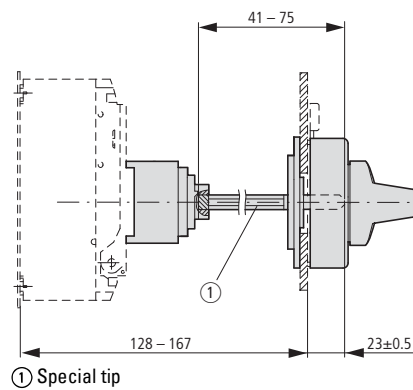

Minimum distance of door coupling rotary handle from door pivot point

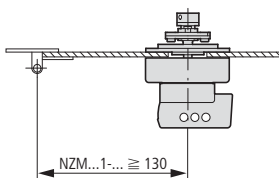

Main switch assembly kit for side wall installation

NZM1-XS(R)-L

NZM1-XS(R)-R

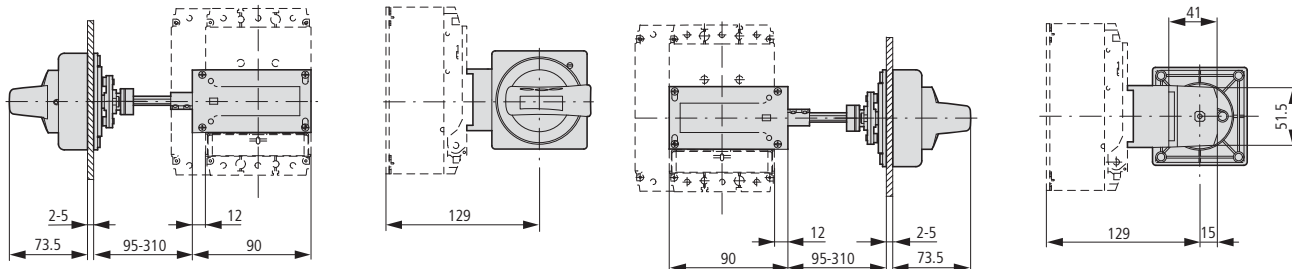

Main switch assembly kit for side wall installation with mounting bracket

NZM1-XS(R)M-L

NZM1-XS(R)M-R

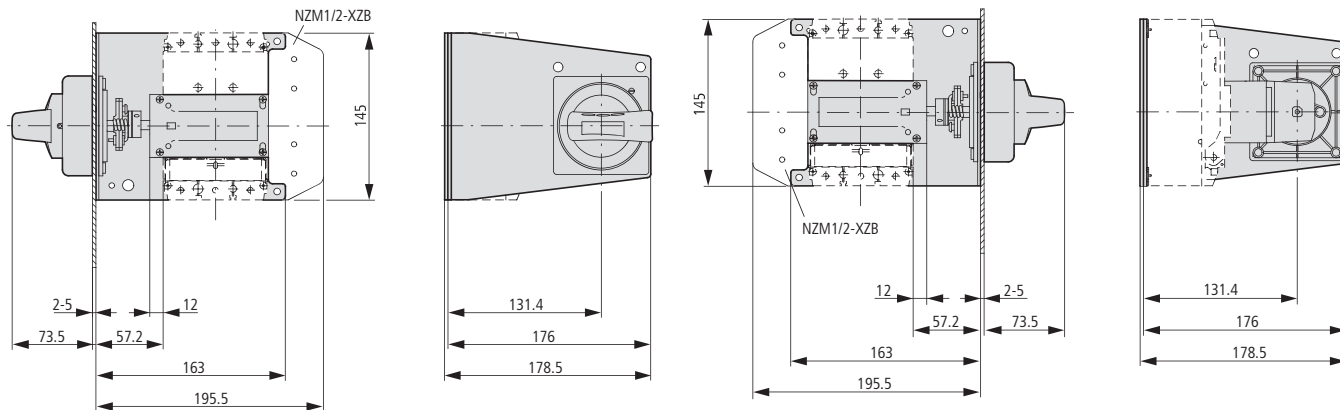

Undervoltage releases

Shunt releases (for power circuit breaker)

Early-make auxiliary contacts

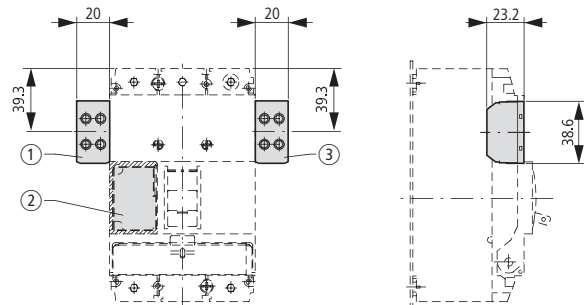

- ① NZM1-XA(HIV)
NZM1-XU(HIV)(20)
NZM1-XHIV
- ② NZM1-XA(HIV)(L)
NZM1-XU(V)(HIV)(L)(20)
NZM1-XHIV(L)
- ③ NZM1-XHIVR

Spacers

NZM1/2-XAB

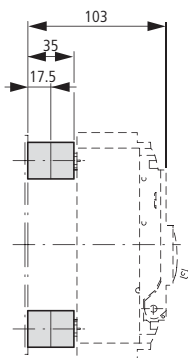

Clip plate

NZM1-XC35

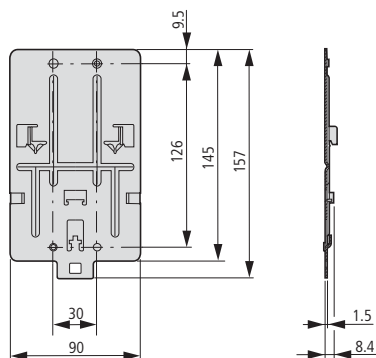

17/194 Circuit-breakers, switch-disconnectors

Construction size 1: accessories

NZM...-X...

Insulating surround

NZM1-XBR

Mounting aperture

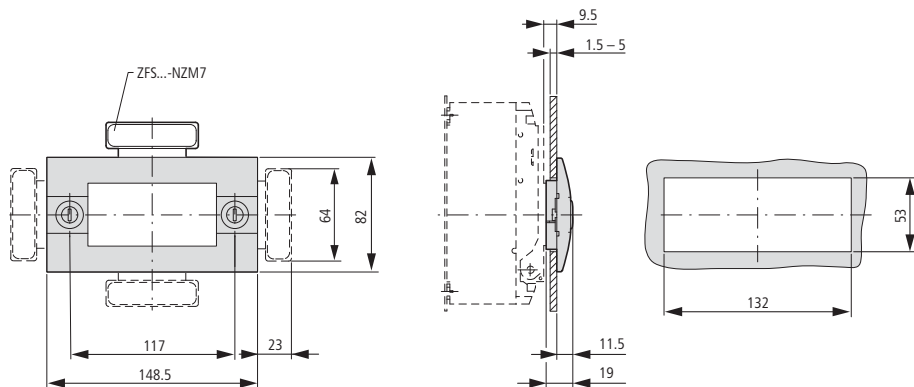

Insulating surround

NZM1-XBRS

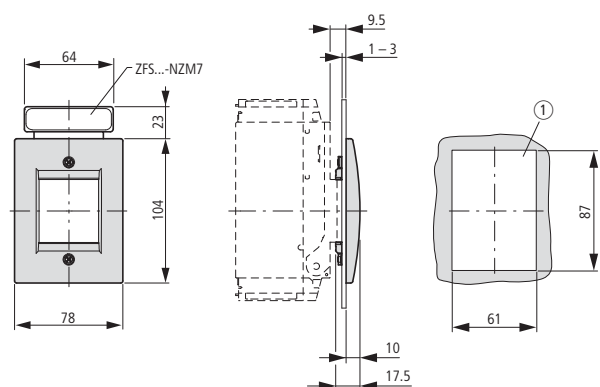

Rotary handle on switch with door interlock

NZM1-XDTV(R)

Mounting aperture

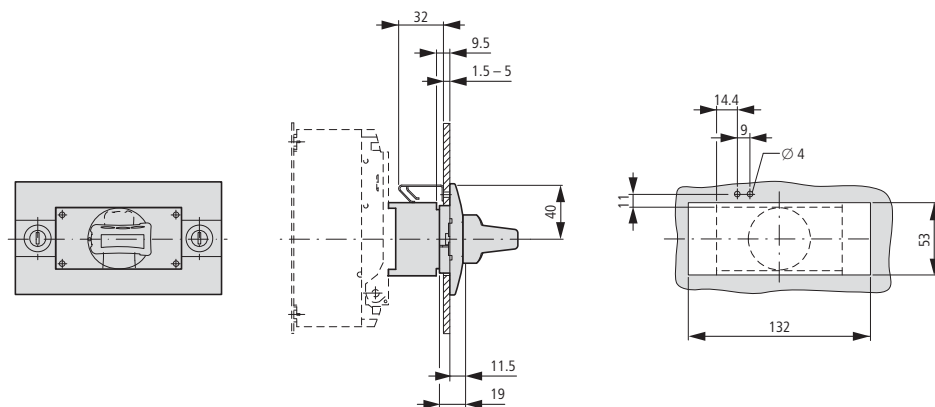

Rear-mounted drives

NZM1-XRAV(R)

NZM1-4-XRAV(R)

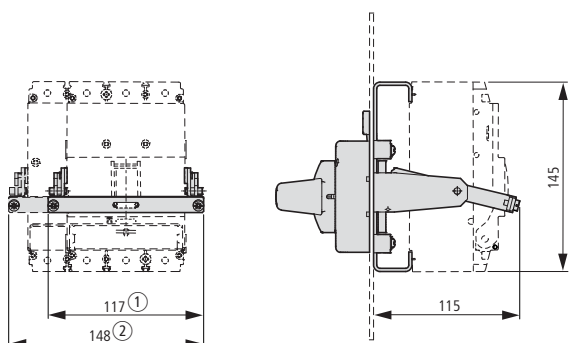

- ① NZM1-XRAV(R)
- ② NZM1-4-XRAV(R)

Toggle lever locking device

NZM-XKAV

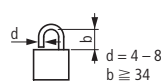
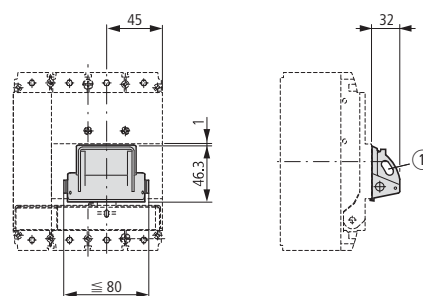

Up to 3 padlocks

Mechanical interlock

NZM1-XMV + NZM1-XDV(R)

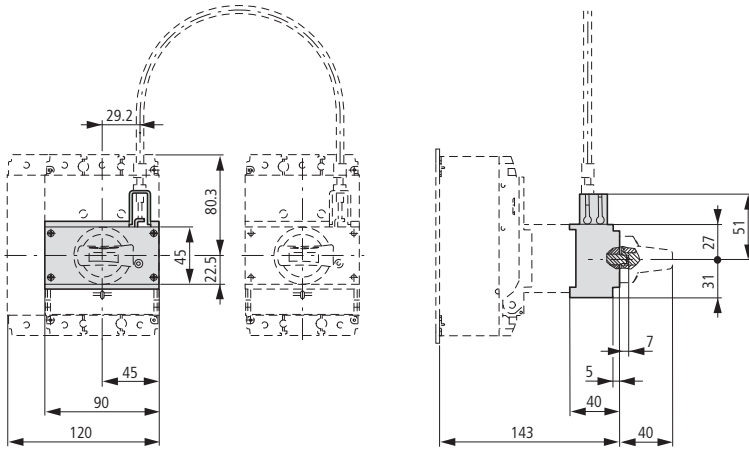

NZM1-XMV + NZM1-XTVD(V)(R)

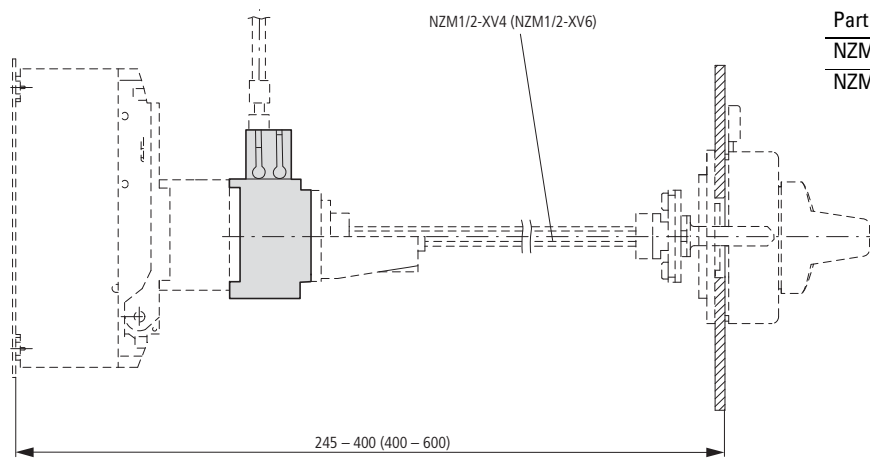

Part no.	x
NZM1/2-XV4	245 - 400
NZM1/2-XV6	400 - 600

NZM1-XMV + NZM1-XTVD(V)(R)-60

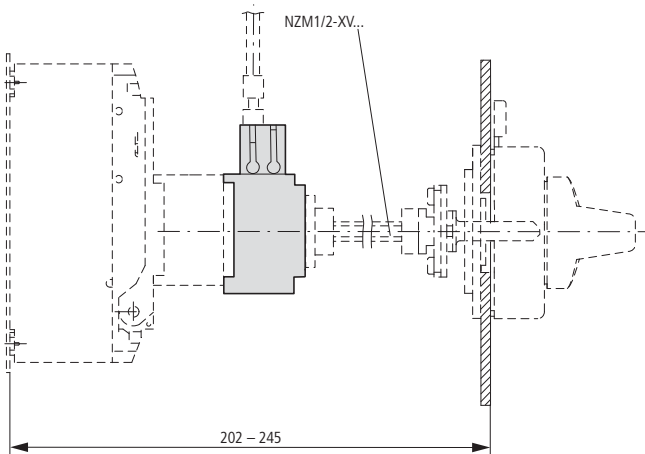

NZM1-XMV + NZM1-XTVD(V)(R)-0

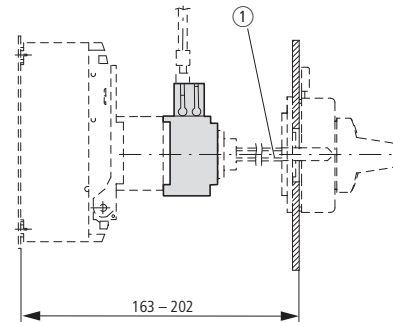

① Special tip



Paralleling mechanism

PN1-XPA

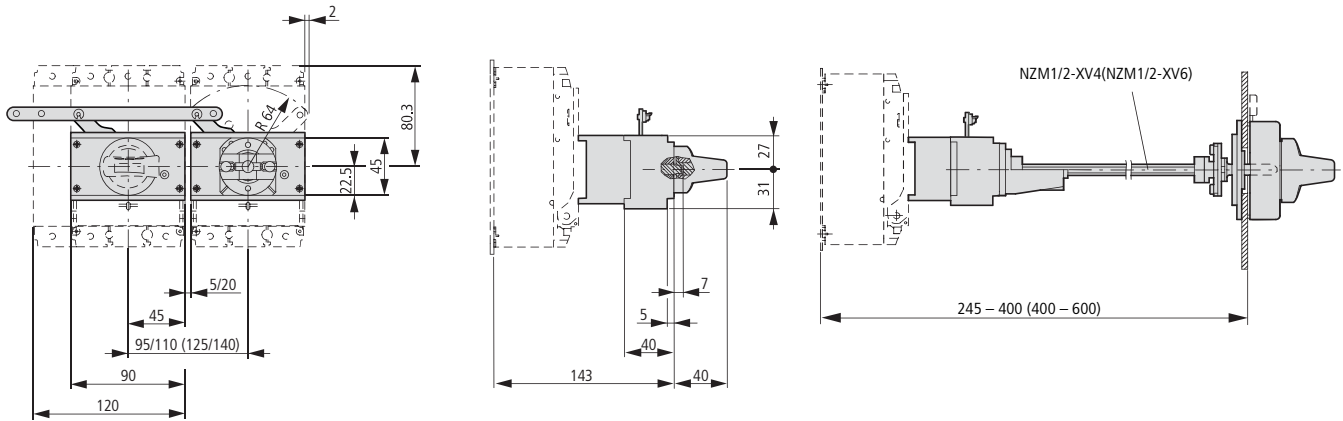

Insulated enclosures

NZM1-XCIK5-T...

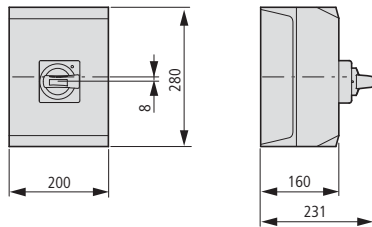

NZM1-XCI23-T...

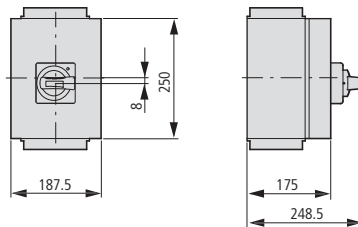

NZM1-XCI43-T...

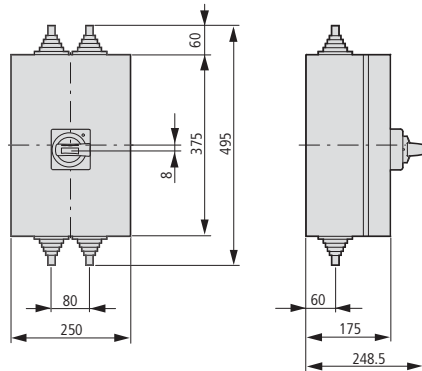

NZM1-XCI43/2-T...

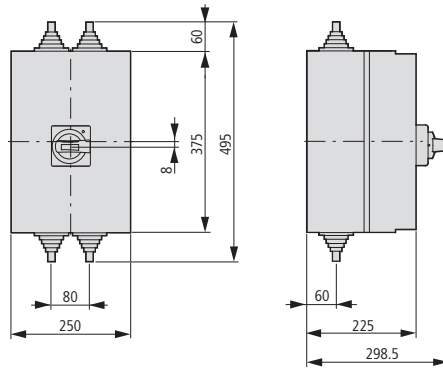

Component adapter

NZM1-XAD160

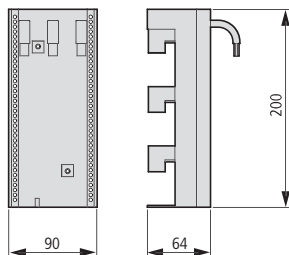

Plug-in units

NZM1-XSVS with
NZM1-...-SVE
N1-...-SVE

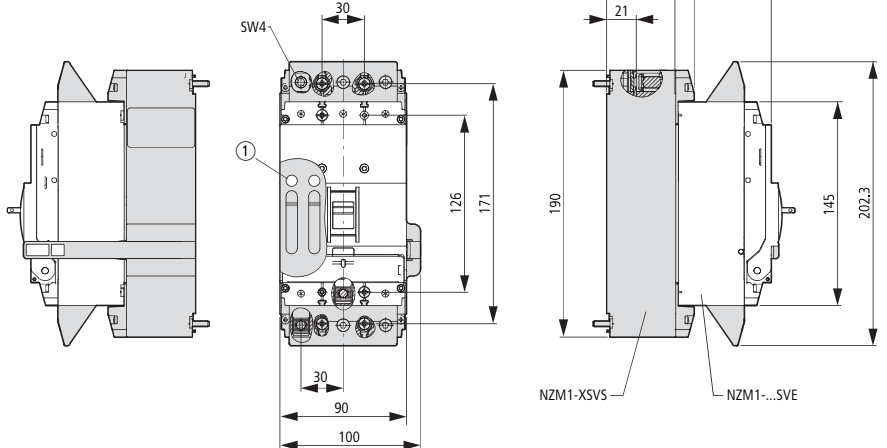

① Up to 2 padlocks

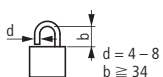

Residual-current relays

PFR-003
PFR-03
PFR-5

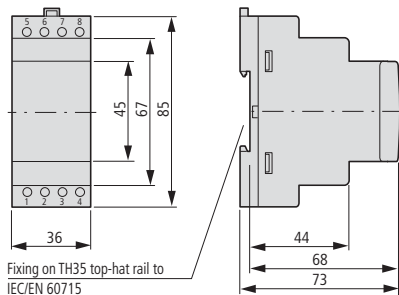

Ring-type transformer

PFR-W-20...30

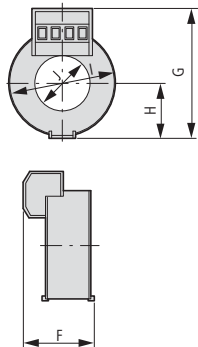

PFR-W-35...210

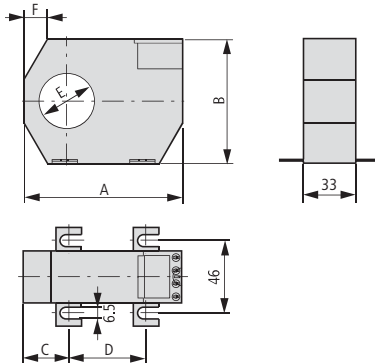

Part no.	F	G	H	I	J
PFR-W-20	32	60	24	46	21
PFR-W-30	32	70	30	59	30

	A	B	C	D	E	F
PFR-W-35	100	79	26	48.5	35	35
PFR-W-70	130	110	32	66	70	52
PFR-W-105	170	146	38	94	105	72
PFR-W-140	220	196	48.5	123	140	97
PFR-W-210	299	284	69	161	210	141

Mounting clip

PFR-WC

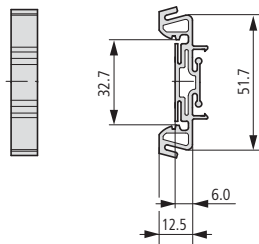

Magnetic shielding

PFR-WMA

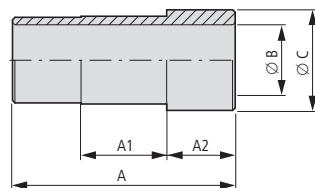

Part no.	A	B	C	A1	A2
PFR-WMA-35	91	28	40	35	28
PFR-WMA-70	105	62	75	35	35
PFR-WMA-105	153	98	110	35	60
PFR-WMA-140	153	133	145	35	60
PFR-WMA-210	153	203	215	35	60

Earth-fault release

NZM1(-4)-XFI...R

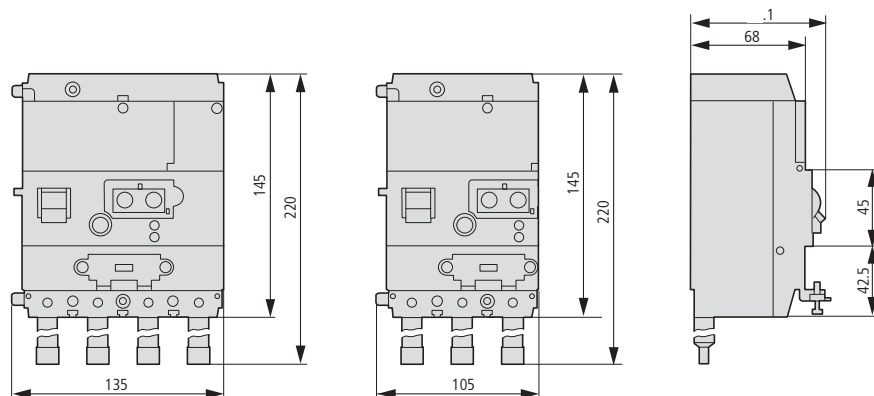

NZM1(-4)-XFI...U

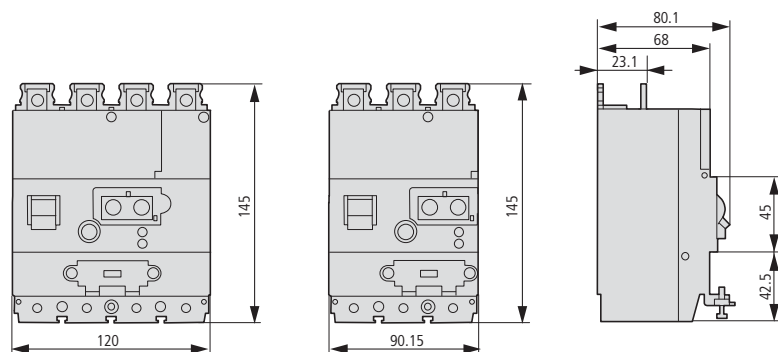

17/198 Circuit-breakers, switch-disconnectors

Construction size 2: basic devices

NZM2, PN2, N2, NS2

Circuit-breakers

Switch-disconnectors

3 pole

- NZMB2
- NZMC2
- NZMN2
- NZMH2
- PN2
- N2
- NS2

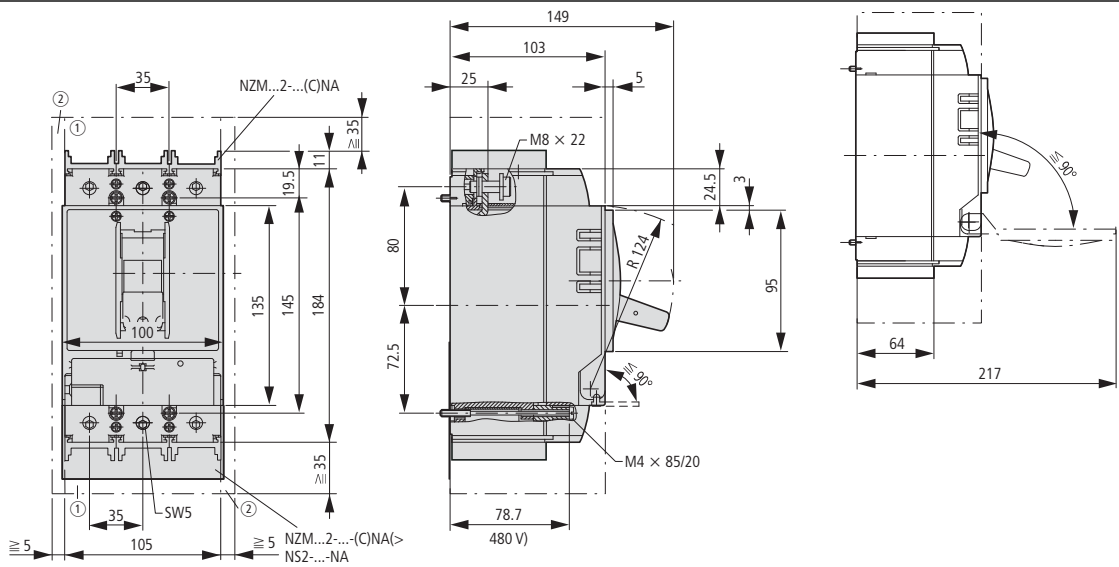

- ① Blow-out area, minimum distance to other parts ≥ 35 mm
- ② Minimum distance to adjacent parts ≥ 5 mm

Circuit-breakers

Switch-disconnectors

4 pole

- NZMB2-4
- NZMC2-4
- NZMN2-4
- NZMH2-4
- PN2-4
- N2-4

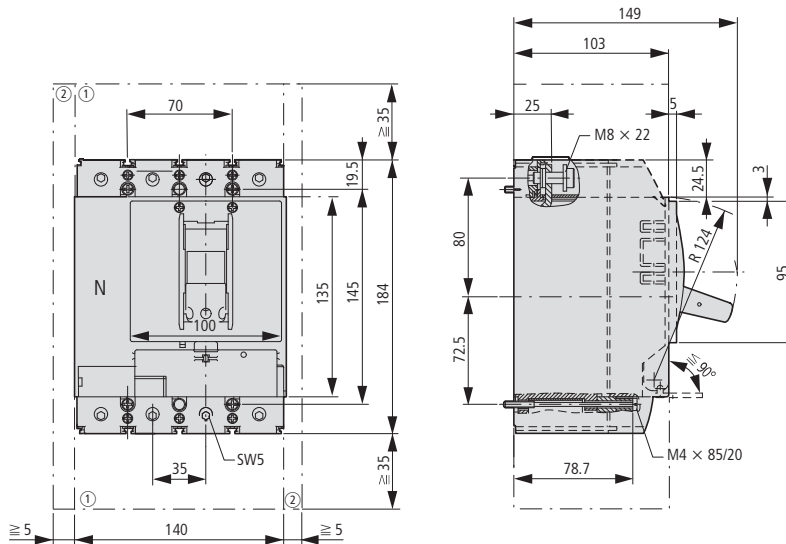

- ① Blow-out area, minimum distance to other parts ≥ 35 mm
- ② Minimum distance to adjacent parts ≥ 5 mm

Switch-disconnectors

ATEX22-type

3 pole

- PN2.../ATEX22

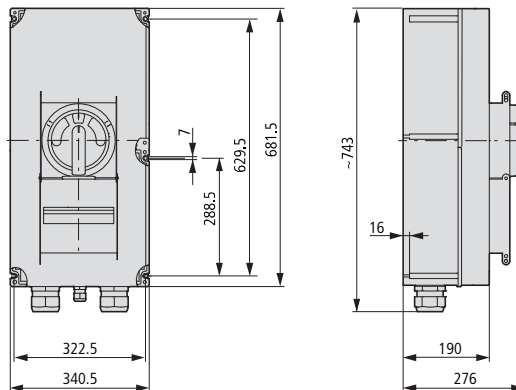

Box terminal

(+)NZM2(-4)-...-XKC(O)(U)

IP2X protection against contact with finger

NZM2(-4)-XIPK

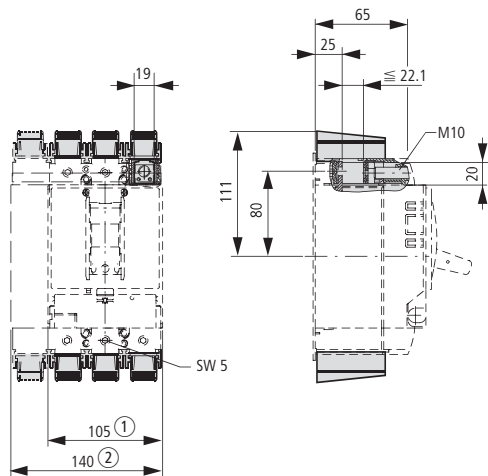

- ① 3 pole
- ② 4 pole

Tunnel terminal

NZM2(-4)-XKA

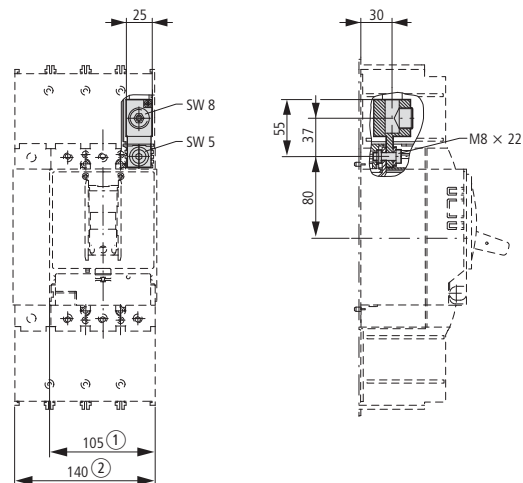

Covers

NZM2(-4)-XKSA

Cable lug

NZM2-XKS185

IP2X protection against contact with a finger for cover

NZM2(-4)-XIPA

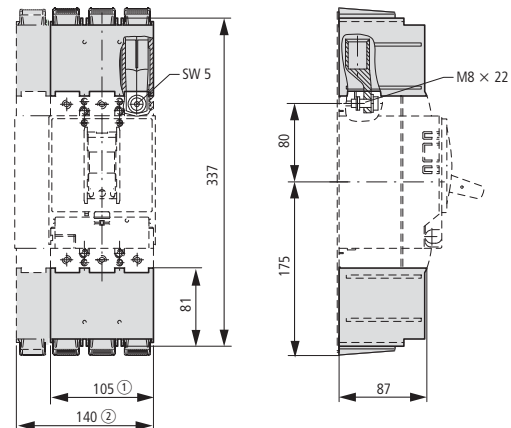

Cable lug cover

NZM2(-4)-XKSAE

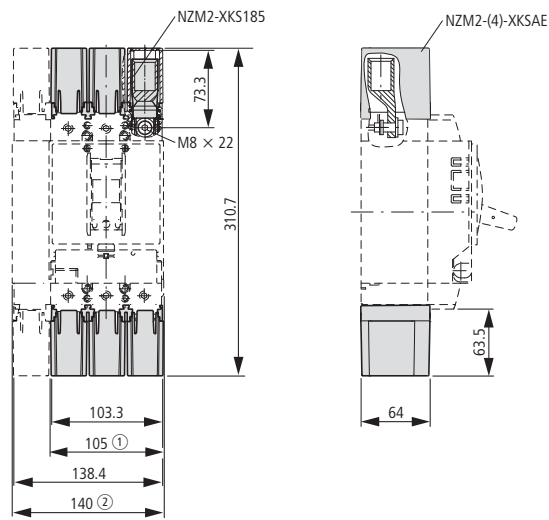

- ① 3 pole
- ② 4 pole

Jumper kit

NZM2-4-XKVP

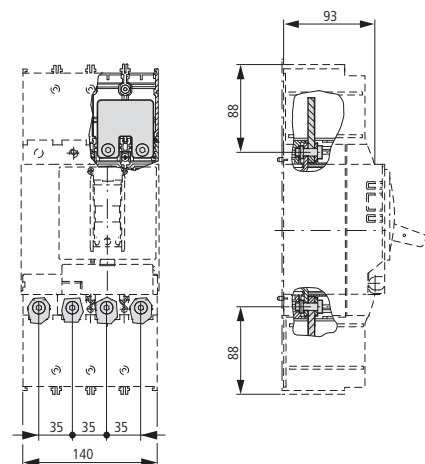

Control cable terminals

NZM2-XSTS

NZM-XSTK

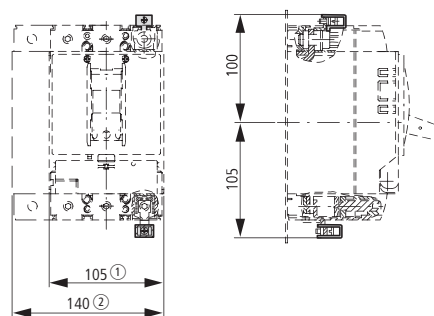

- ① 3 pole
- ② 4 pole



17/200 Circuit-breakers, switch-disconnectors

Construction size 2: accessories

NZM2...-XKR..., NZM2-XDV..., NZM2-XDTV...

Rear terminal bolts

(+)NZM2(-4)-XKR(O)(U)

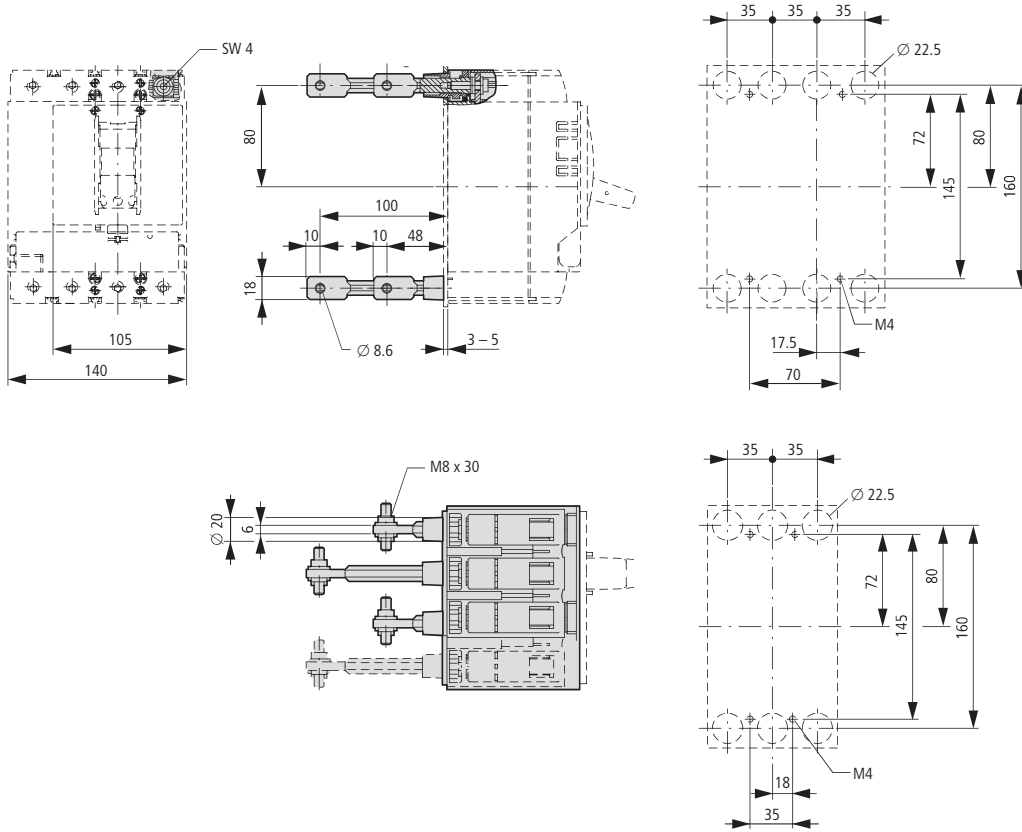

Rotary mechanism

Rotary handle on circuit-breaker

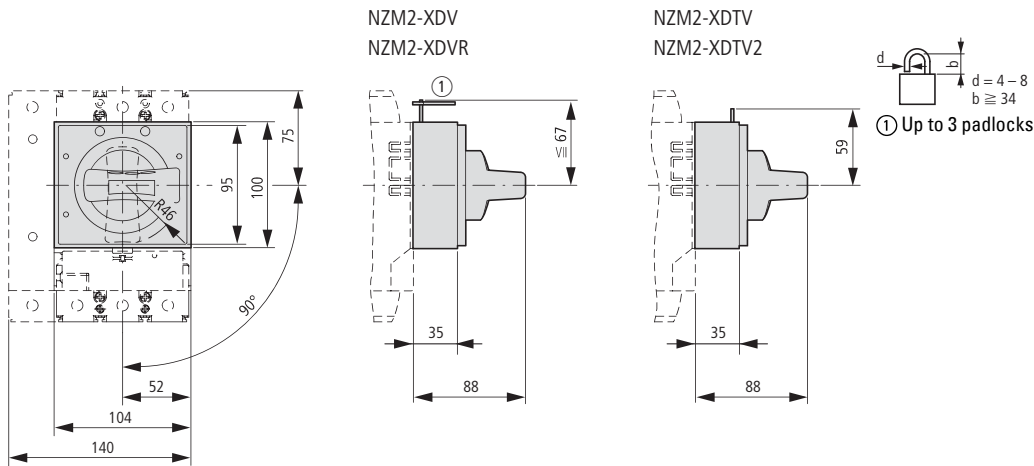

Door coupling rotary handles

NZM2-XTVD(V)(R)...

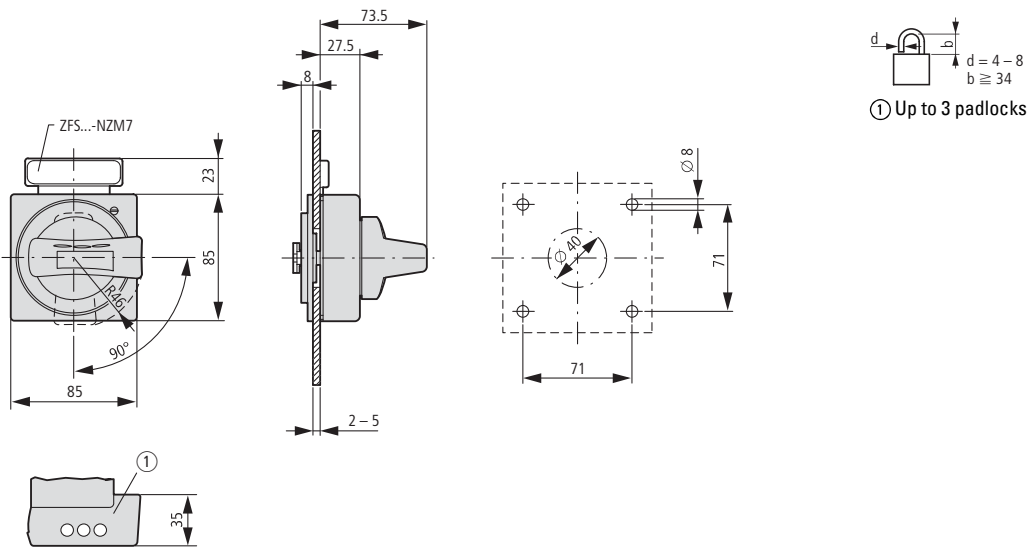

Door coupling rotary handle with extension shaft

NZM2-XTVD(V)(R)(-NA)

NZM1/2-XV4(6)

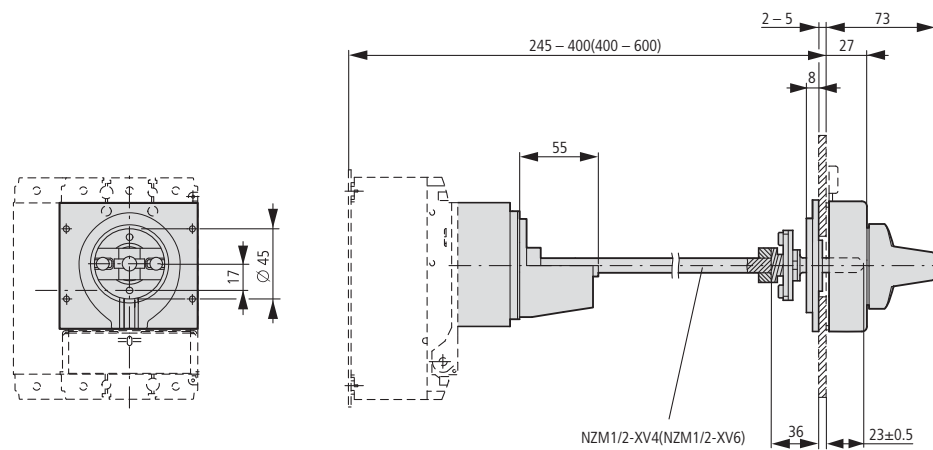

Main switch assembly kit with additional rotary handle

NZM2-XHB-DA(R)(-NA)

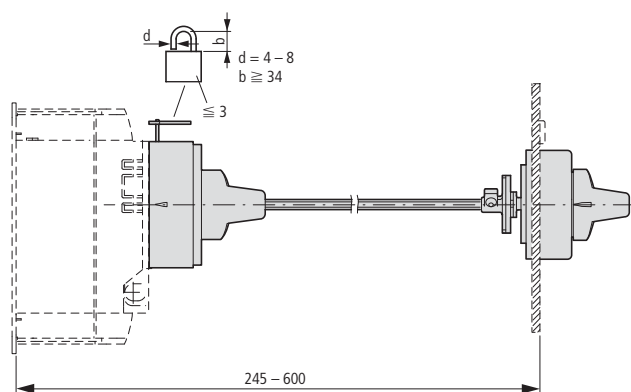

17/202 Circuit-breakers, switch-disconnectors

Construction size 2: accessories

NZM2-XTVD..., NZM2-XS...

Door coupling rotary handle with extension shaft

NZM2-XTVD(V)(R)-60(-NA)

NZM2-XTVD(V)(R)-0(-NA)

Minimum distance of door coupling rotary handle from door pivot point

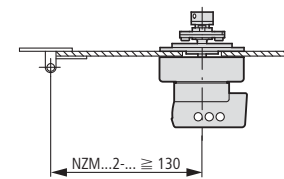
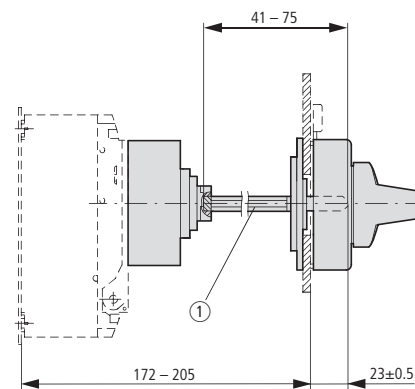
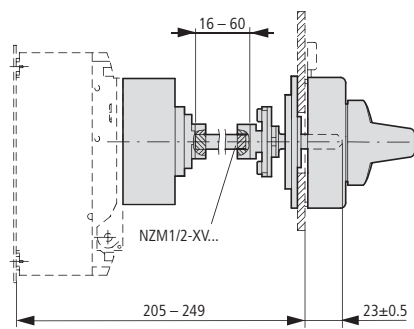

① Special tip

Main switch assembly kit for side wall installation

NZM2-XS(R)-L

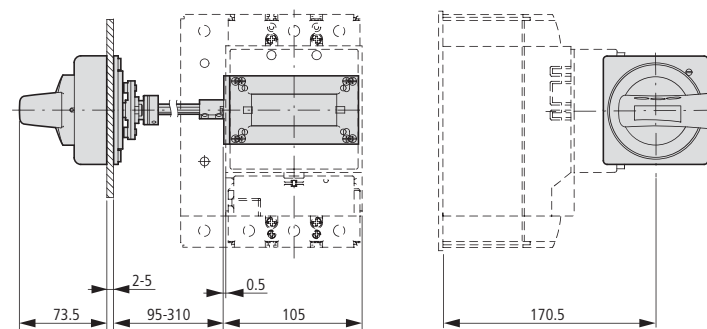

NZM2-XS(R)-R

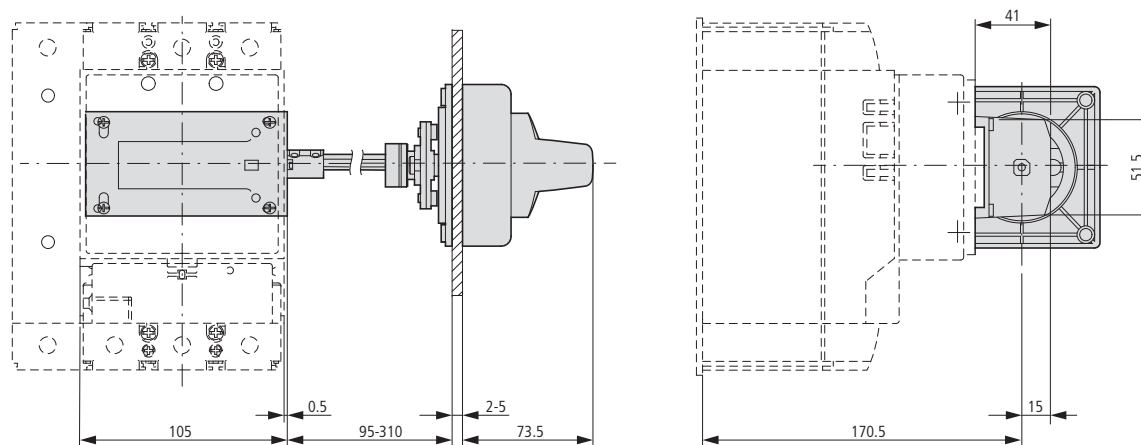

Main switch assembly kit for side wall installation with mounting bracket.

NZM2-XS(R)M-L

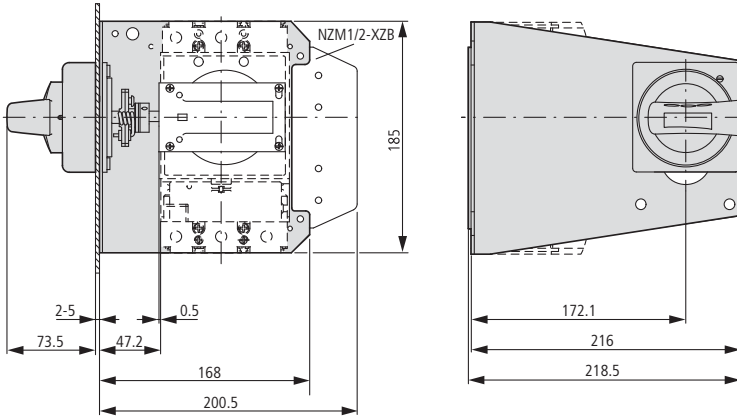

NZM2-XS(R)M-R

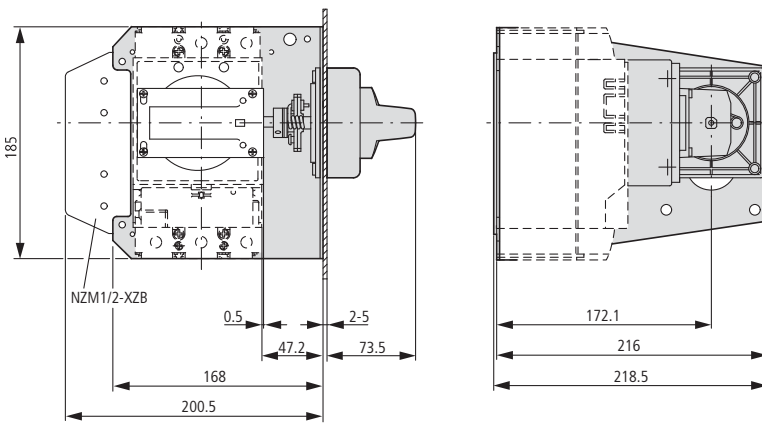

Rear-mounted drives

NZM2(-4)-XRAV(R)

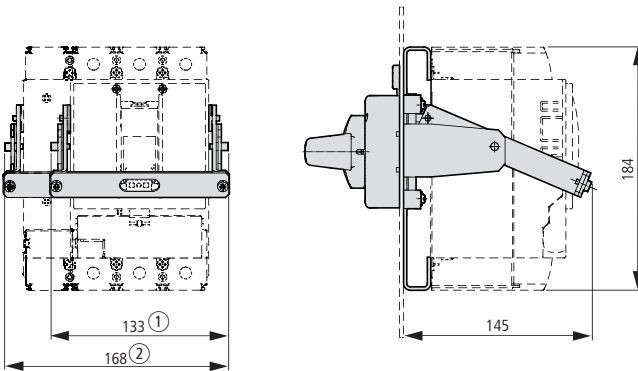

- ① NZM2-XRAV(R)
- ② NZM2-4-XRAV(R)



17/204 Circuit-breakers, switch-disconnectors

Construction size 2: accessories

NZM...-XAB, NZM2-XBR, NZM2-XDTV...

Spacers

NZM1/2-XAB

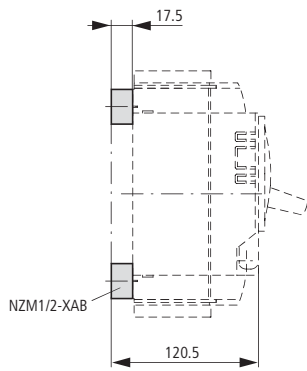

Clip plate

NZM2-XC75

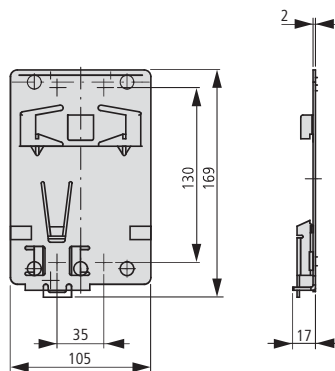

Insulating surround

NZM2-XBR

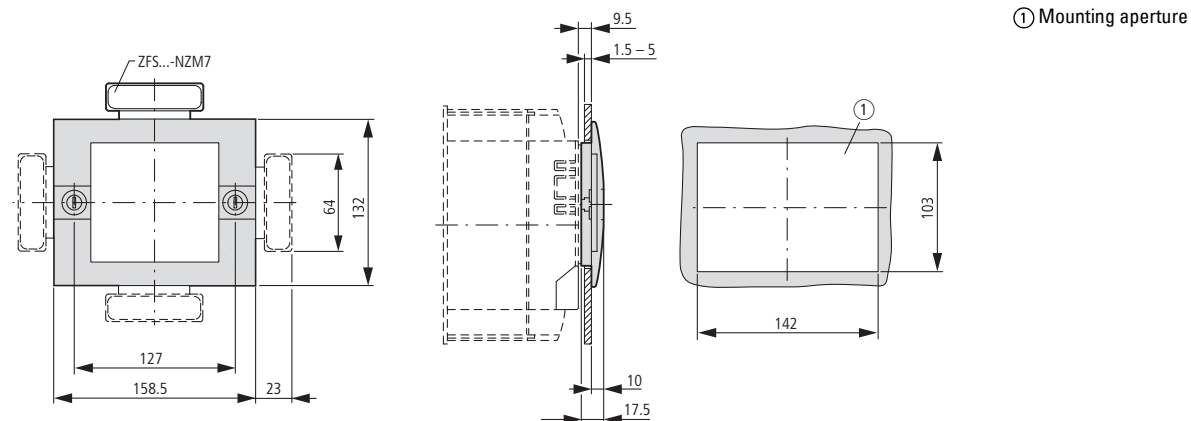

NZM2/3-XBRS

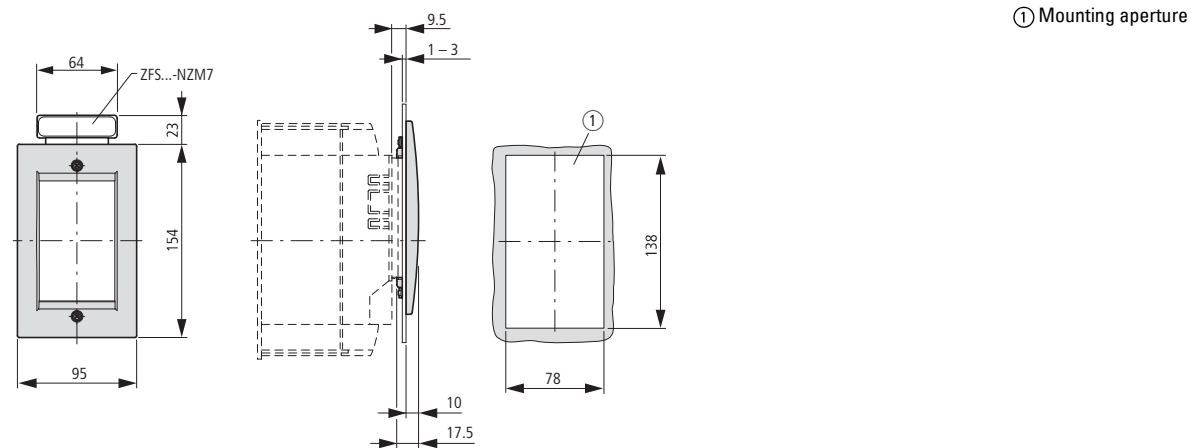

Rotary handle on switch with door interlock

NZM2-XDTV(R)

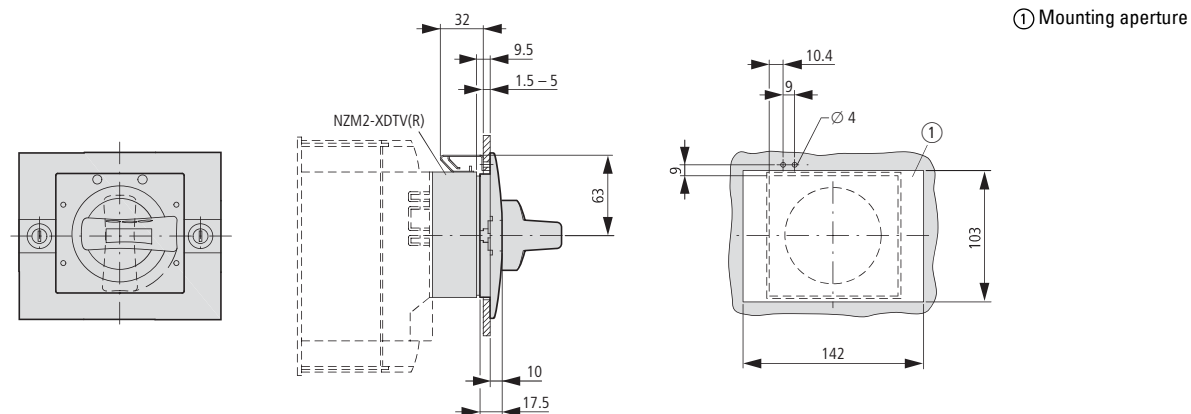

Toggle lever locking device

NZM2/3-XKAV

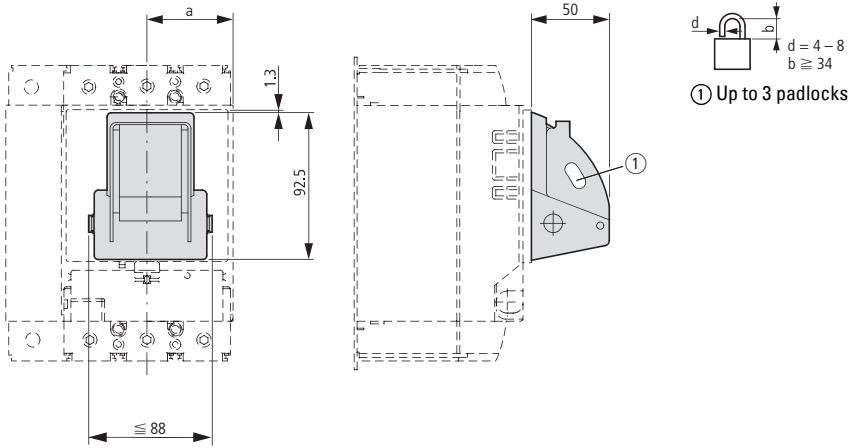

Part no.	a
NZM2, PN2, N2	52.5
NZM3, PN3, N3	70

Side-mounted handle

NZM2...-XSH...

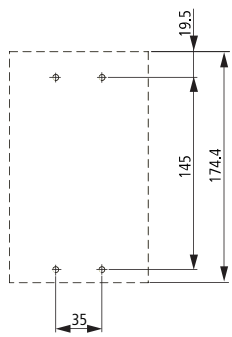
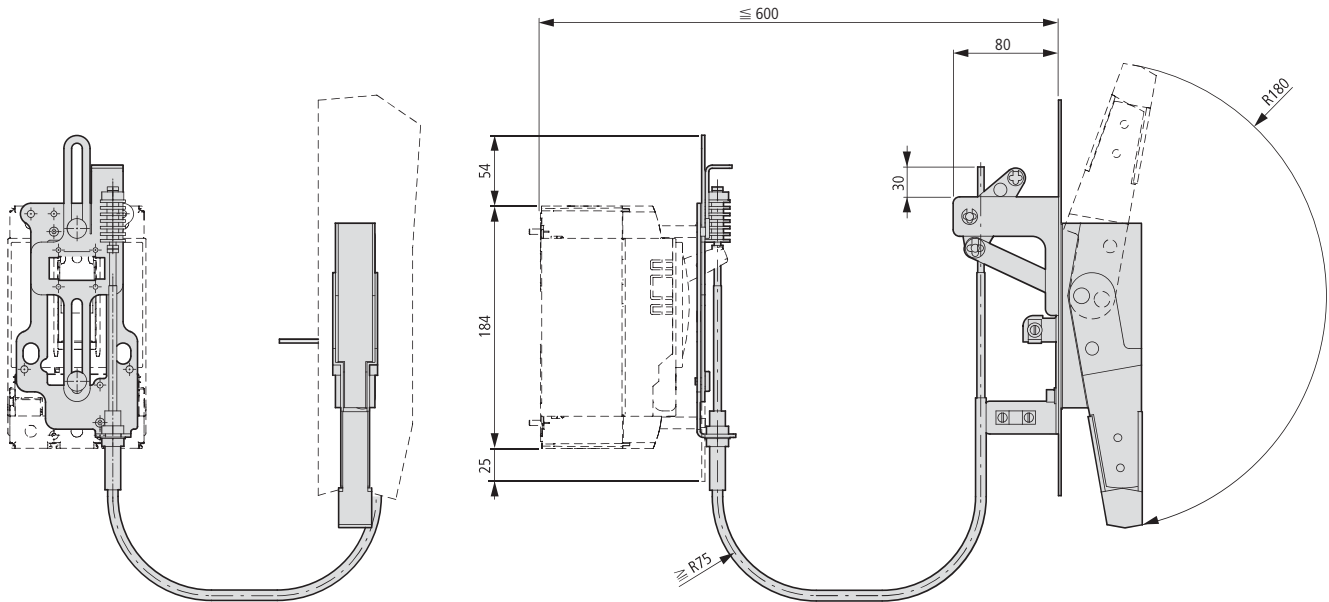

Drilling template



17/206 Circuit-breakers, switch-disconnectors

Construction size 2: accessories

NZM2-XMV, NZM2-XTVD..., NZM2-XD

Mechanical interlock

NZM2-XMV + NZM2-XD

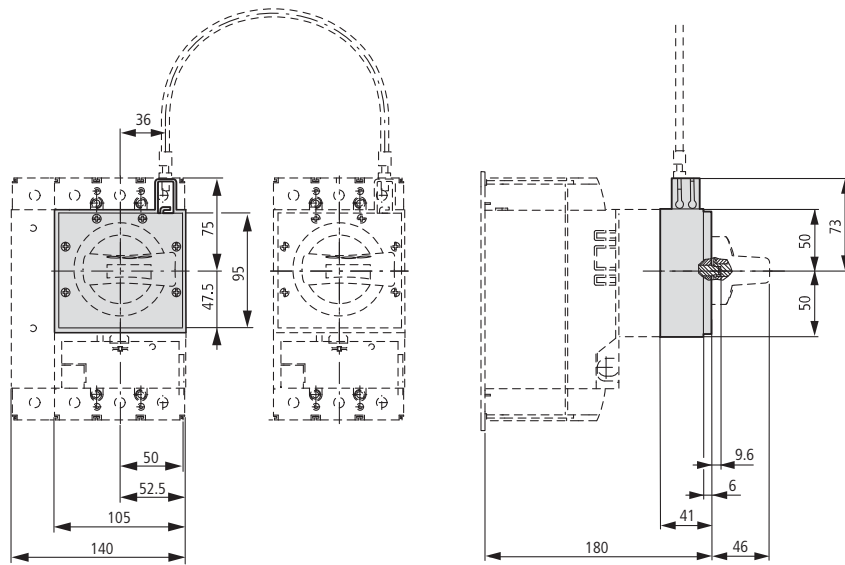

NZM2-XMV + NZM2-XTVD(V)(R)

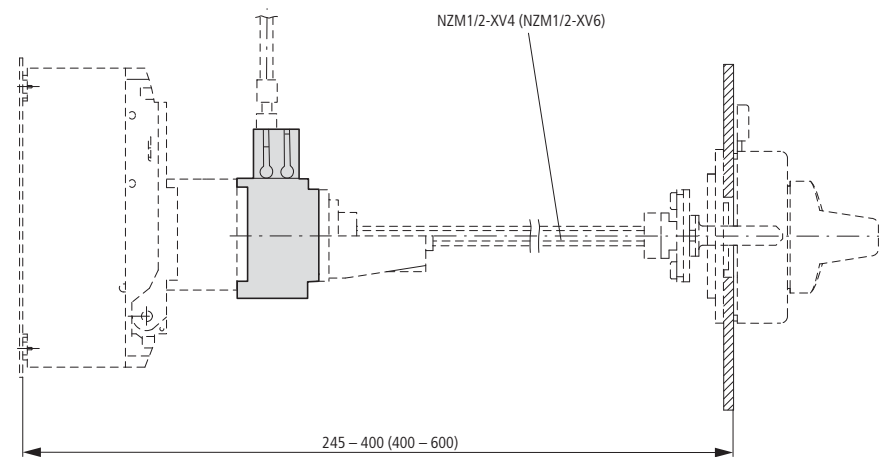

NZM2-XMV + NZM2-XTVD(V)(R)-60

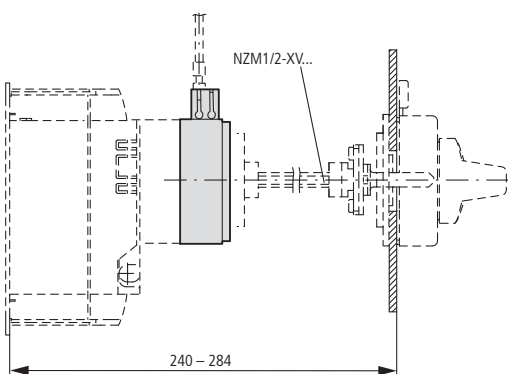

NZM2-XMV + NZM2-XT(V)D(V)(R)-0

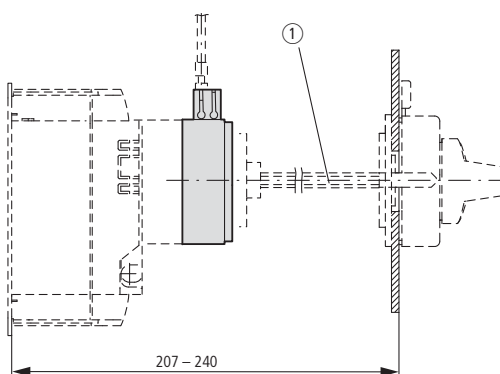

① Special tip

Paralleling mechanism

PN2-XPA

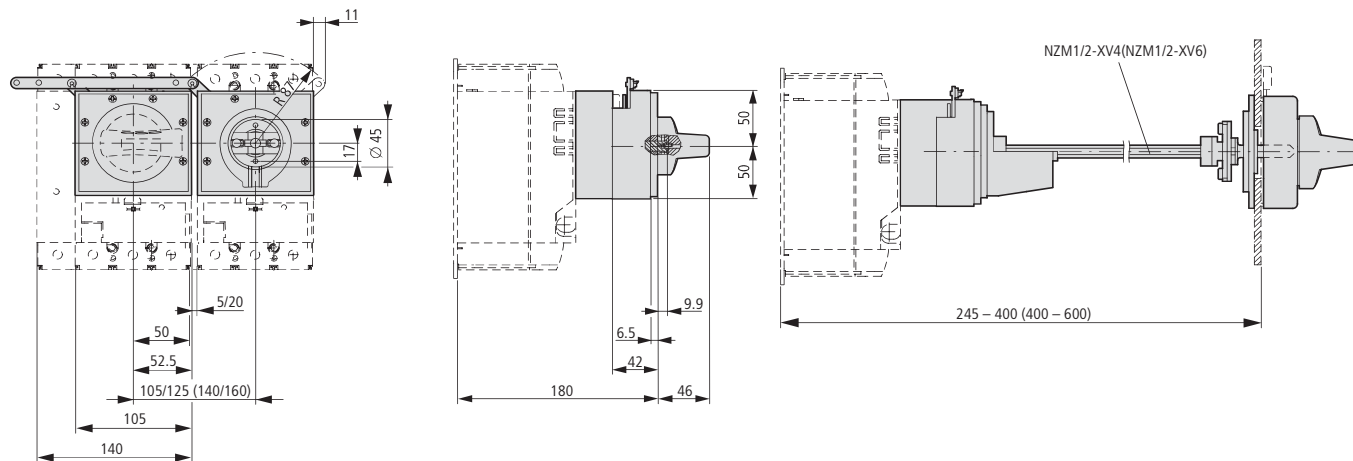

Remote operators

NZM2-XR...

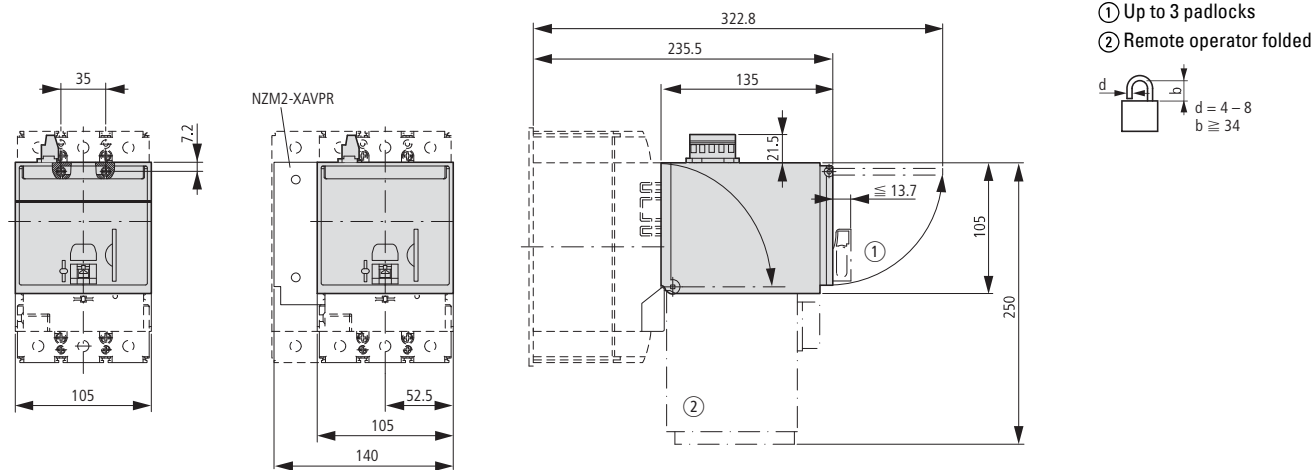

NZM2-XRD...

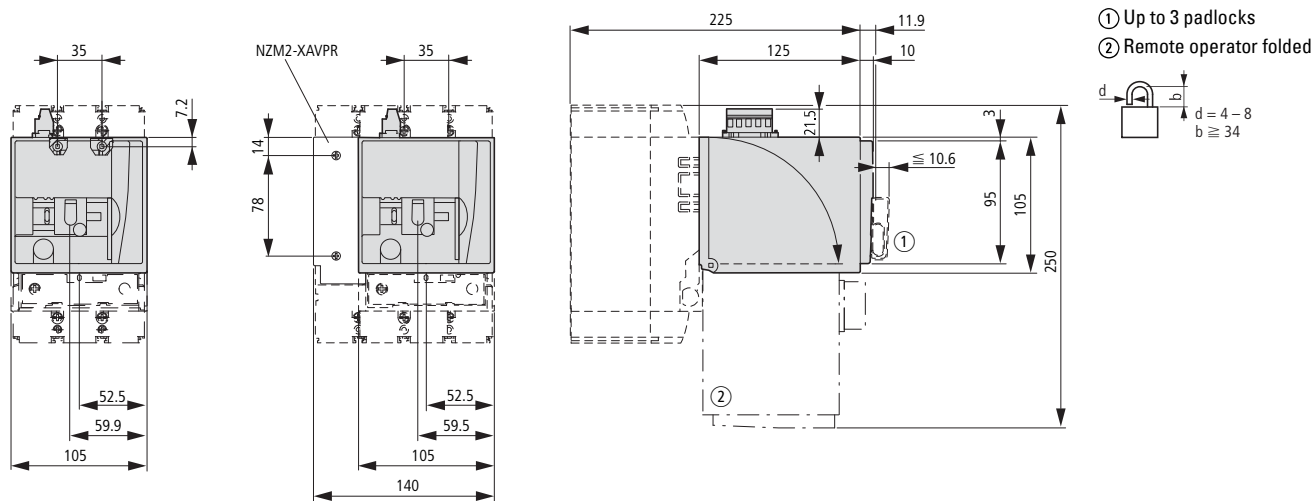

17/208 Circuit-breakers, switch-disconnectors

Construction size 2: accessories

NZM2-XCI..., NZM2-XAD, NZM2...-XSVS

Insulated enclosures

NZM2-XCI43-T...

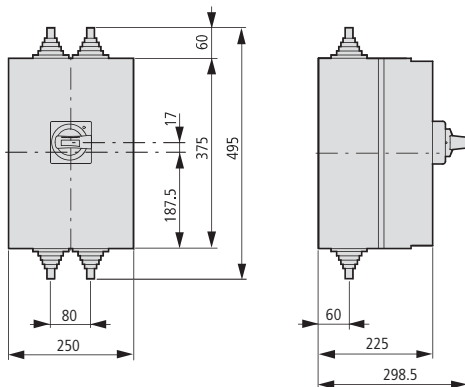

NZM2-XCI45-T...

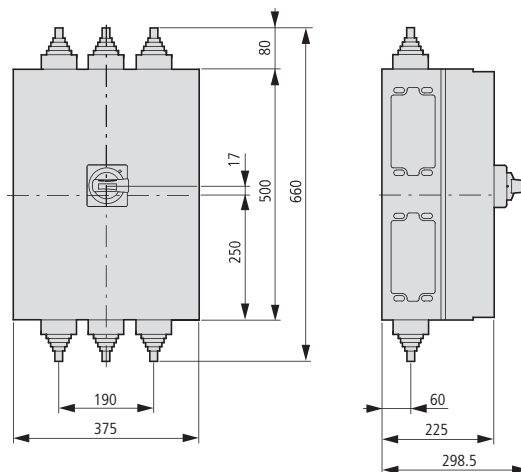

Component adapter

NZM2-XAD250

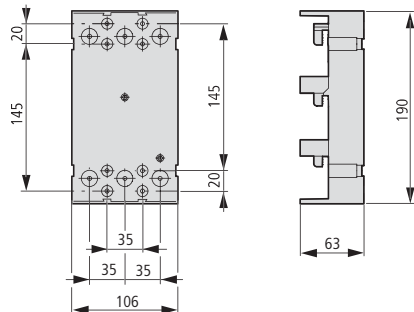

Plug-in units

NZM2...-SVE

N2...SVE

NZM2(-4)-XSVS

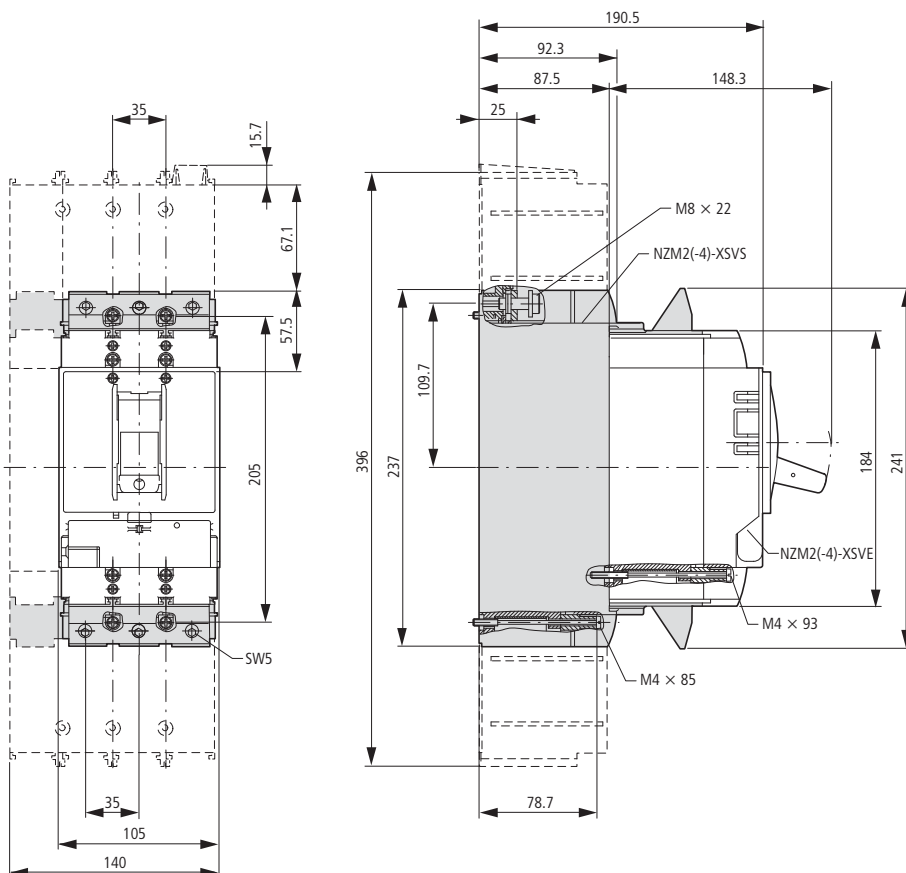

NZM2(-4)-XFI, NZM-XDMI..., UVU-NZM

Earth-fault release

NZM2(-4)-XFI...

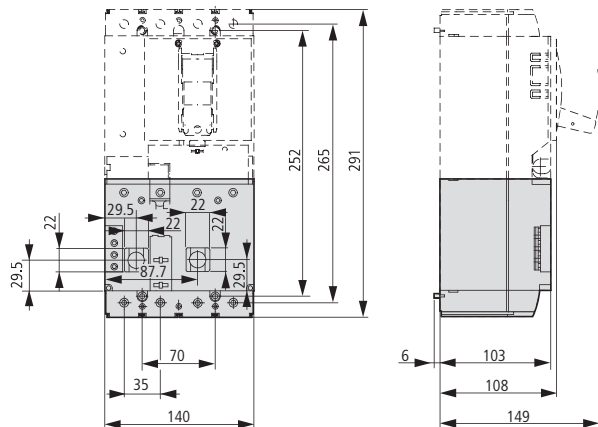

Earth-fault release

NZMH2...-XFIA30

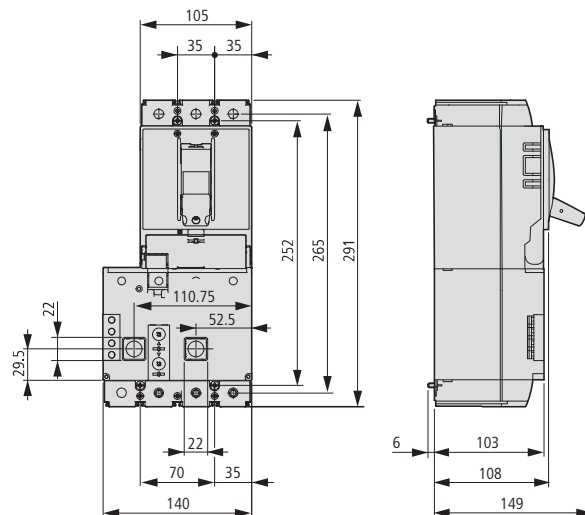

Data management interface (DMI module)

NZM-XDMI612

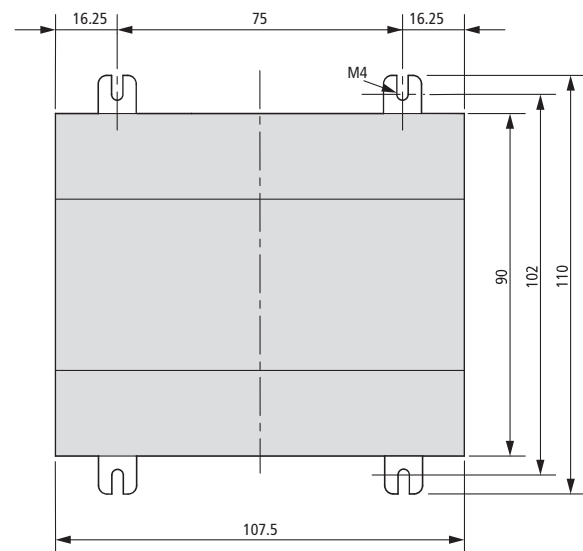

NZM-XDMI-DPV1
EASY2...

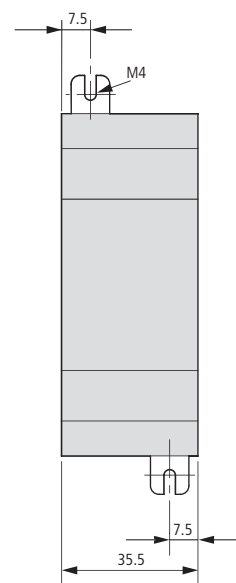

NZM-XDMI...
EASY2...

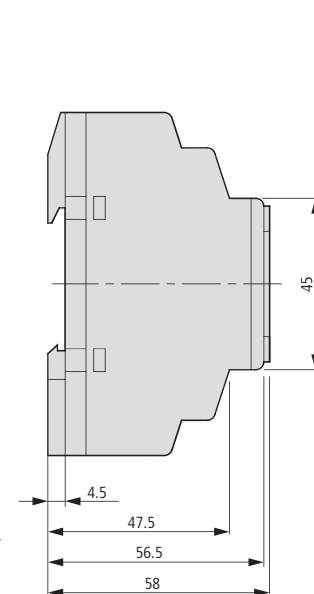

Undervoltage releases, off-delayed

UVU-NZM

Capacitor unit

NZM-XCM

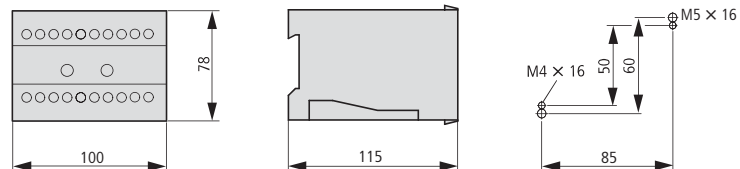

17/210 Circuit-breakers, switch-disconnectors

Construction size 3: basic devices

NZM3, PN3, N3, NS3

Circuit-breakers

Switch-disconnectors

3 pole

NZMC3

PN3

N3

NS3

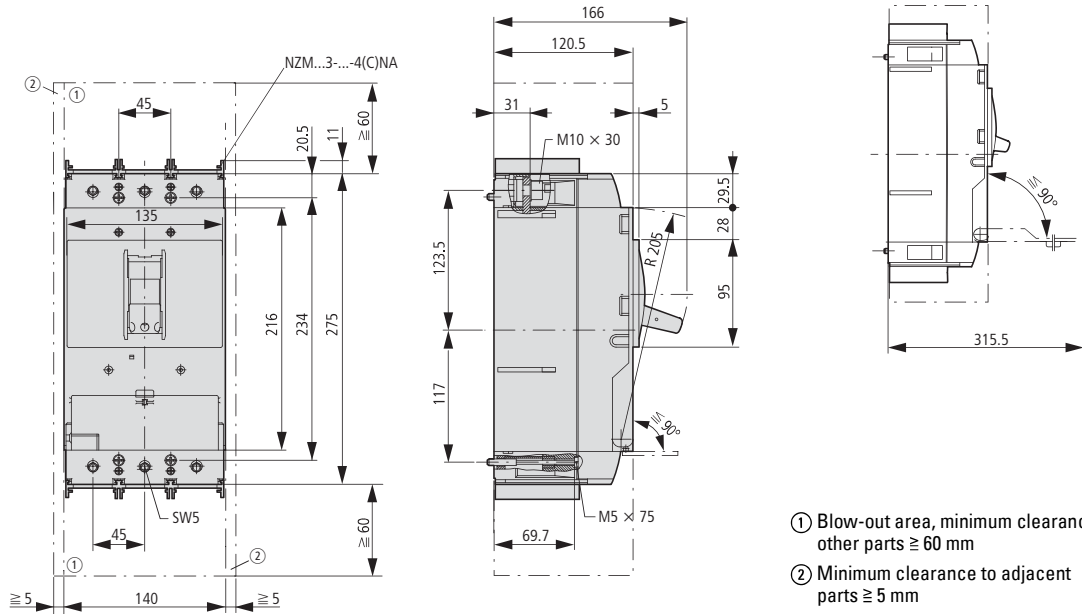

- ① Blow-out area, minimum clearance to other parts ≥ 60 mm
- ② Minimum clearance to adjacent parts ≥ 5 mm

Circuit-breakers

Switch-disconnectors

4 pole

NZMC3-4

NZMN3-4

NZMH3-4

PN3-4

N3-4

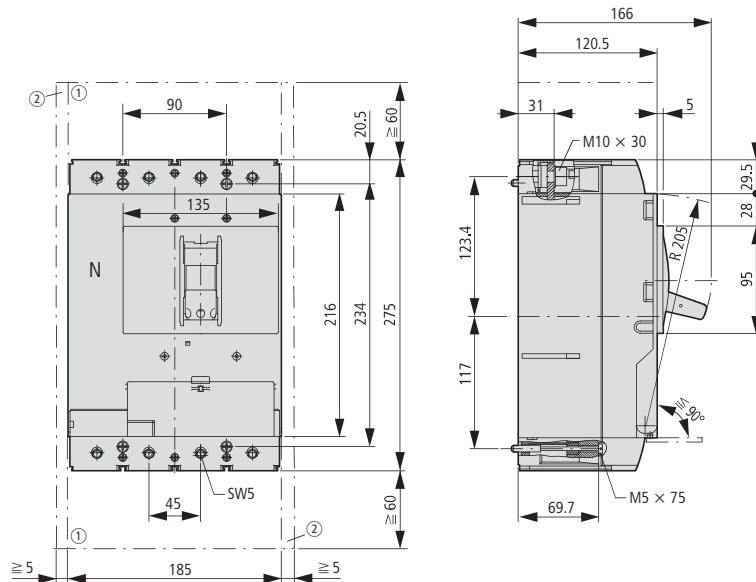

- ① Blow-out area, minimum clearance to other parts ≥ 60 mm
- ② Minimum clearance to adjacent parts ≥ 5 mm

Switch-disconnectors

ATEX22-type

3 pole

PN3.../ATEX22

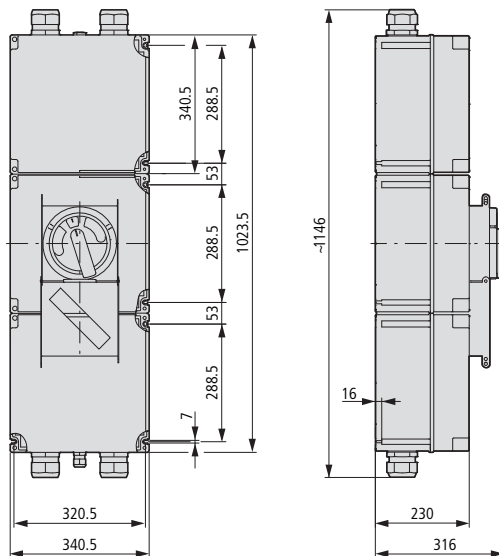

Box terminal

(+)NZM3(-4)-XKC(O)(U)

IP2X protection against contact with finger

NZM3(-4)-XIPK

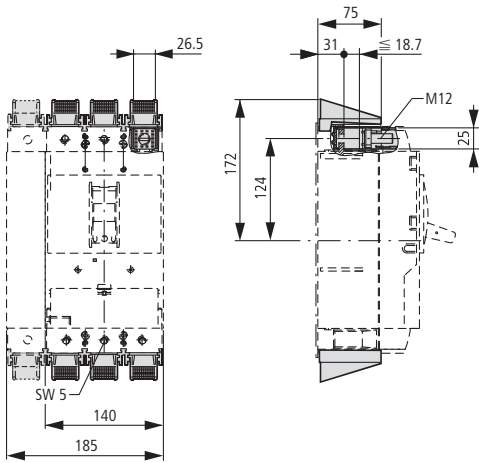

Tunnel terminal

NZM3(-4)-XKA1(2)

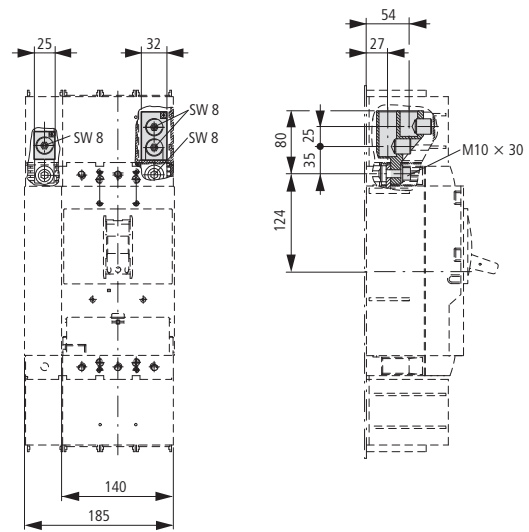

Cover

NZM3(-4)-XKSA

Cable lug

NZM3-XKS185

IP2X protection against contact with a finger

NZM3(-4)-XIPA

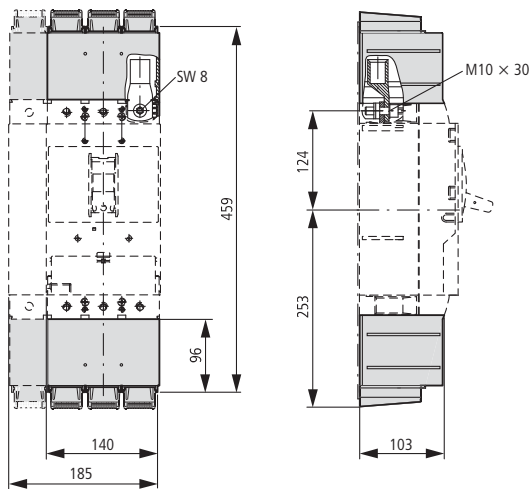

Cable lug cover

NZM3(-4)-XKSAE

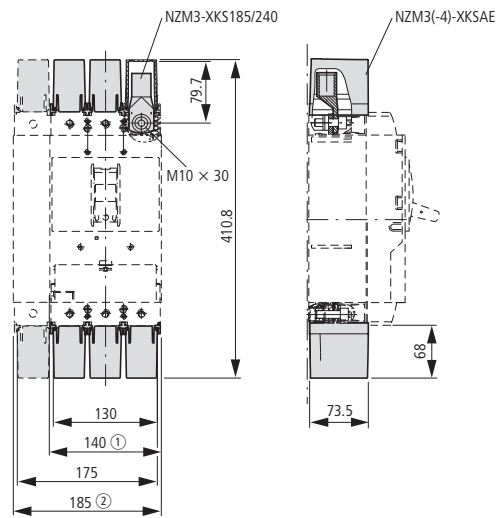

- ① 3 pole
- ② 4 pole



17/212 Circuit-breakers, switch-disconnectors

Construction size 3: accessories

NZM3...XK...

Connection width extension

NZM3(-4)-XKV70

Terminals

NZM3(-4)-XK22X21

NZM3(-4)-XK300

Length with phase isolators approx. 599 mm

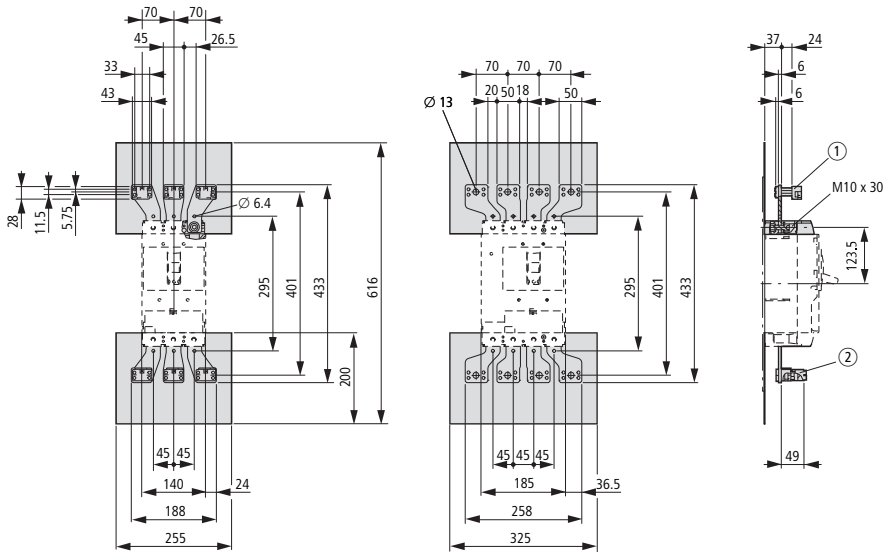

- ① NZM3(-4)-XK22X21
- ② NZM3(-4)-XK300

Connection width extension

NZM3-XKV70KB

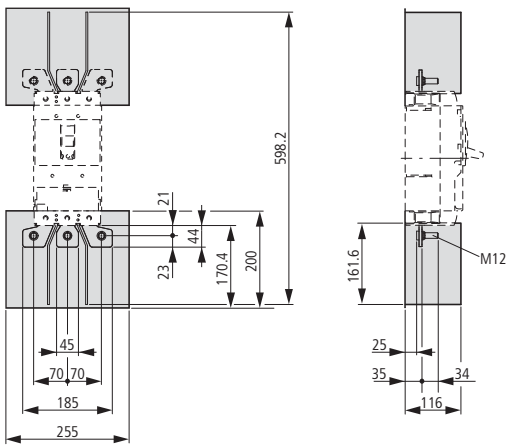

Connection width extension

NZM3-XKV70-2

Cover, large

NZM3-XKSAV

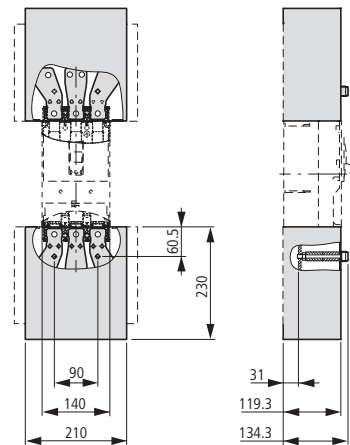

Rear terminal bolts

(+NZM3(-4)-XKR(O)(U)

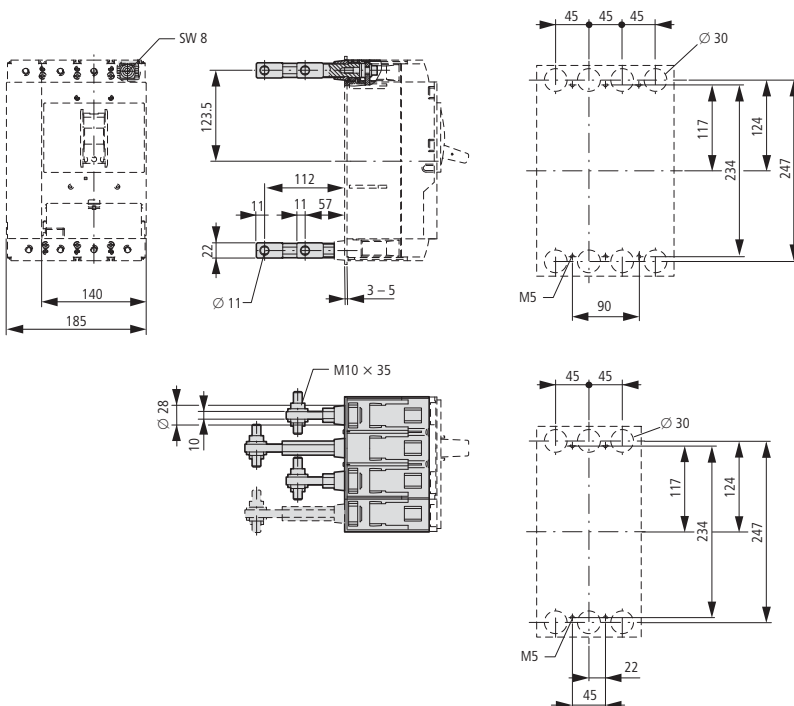

Control cable terminals

NZM3/4-XSTS

NZM-XSTK

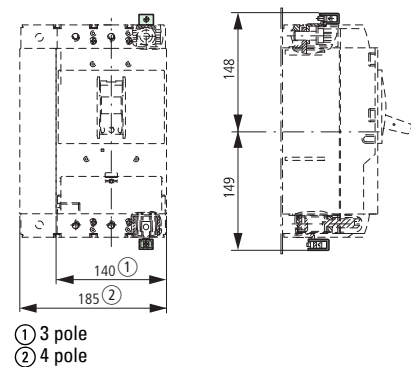

- ① 3 pole
- ② 4 pole

NZM3...-XKP, NZM3-XAB, NZM3-XBR, NZM3-XKV2P

Jumper kit

NZM3(-4)-XKV2P...

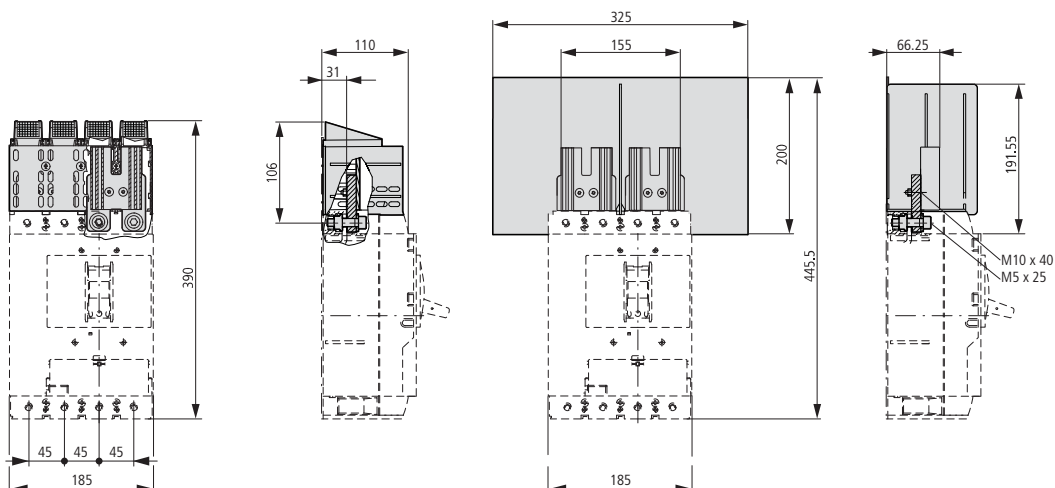

Phase isolators

NZM3-4-XKP

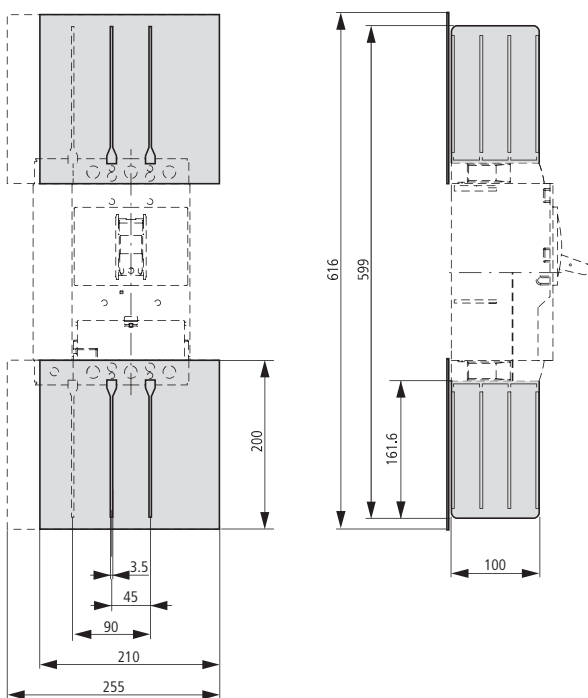

Spacers

NZM3-XAB

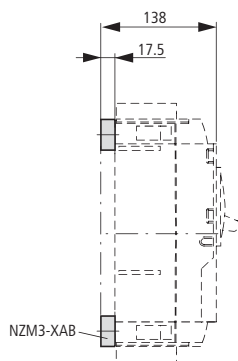

Insulating surround

NZM3-XBR

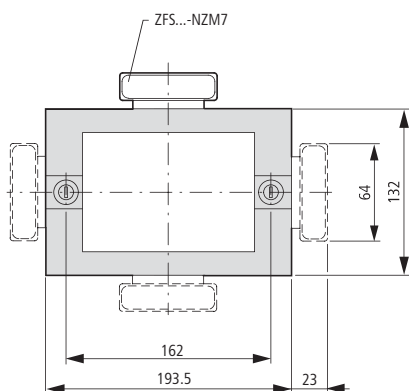

① Mounting aperture

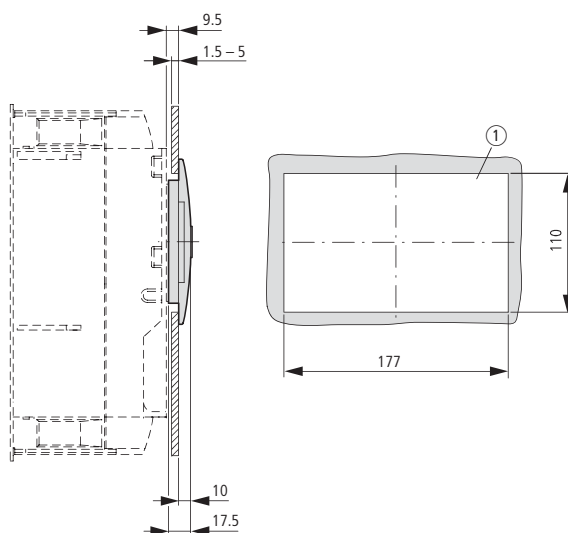

17/214 Circuit-breakers, switch-disconnectors

Construction size 3: accessories

NZM3-XDV..., NZM3-XTVD...

Rotary drive

Rotary handle on circuit-breaker

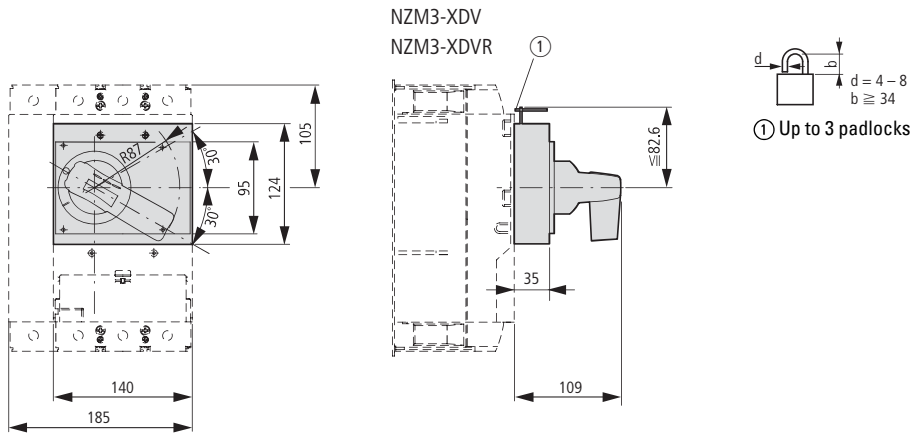

Door coupling rotary handles

NZM3-XTVD(V)(R)...

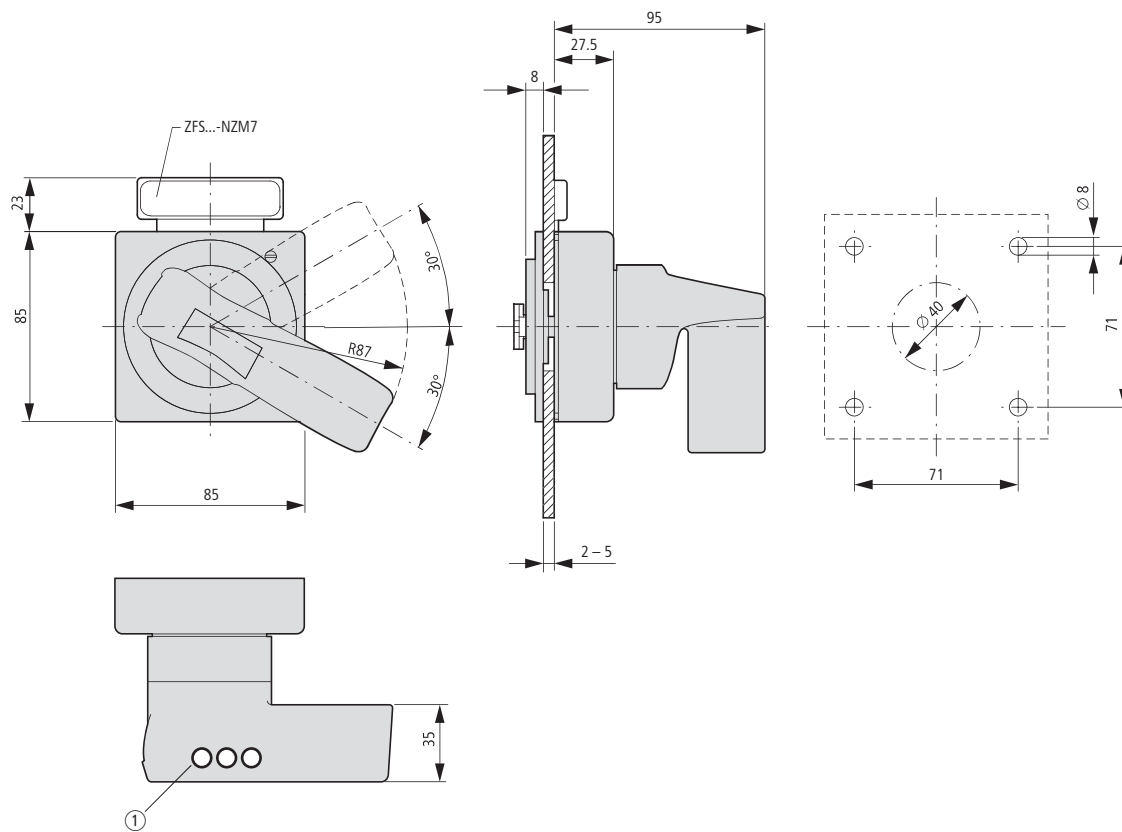

Door coupling rotary handle with extension shaft

NZM3-XTVDV(R)(-NA)

NZM3/4-XV4(6)

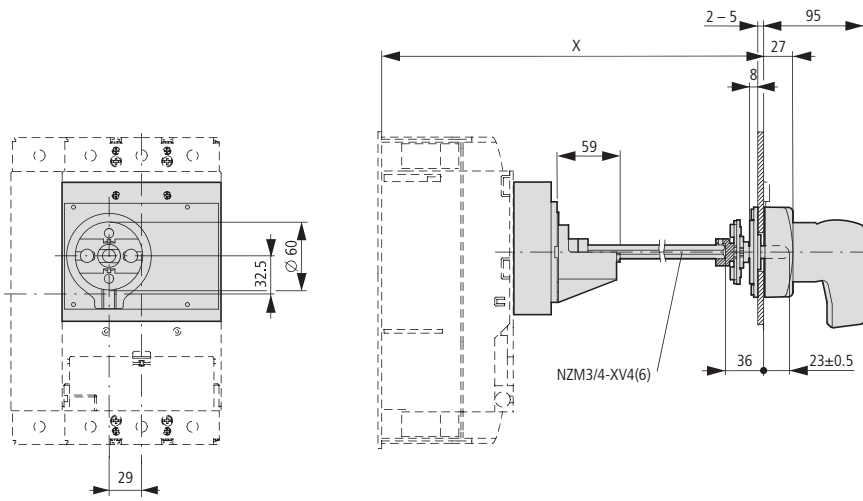

Part no.	x
NZM3/4-XV4	270 – 400
NZM3/4-XV6	400 – 600

NZM3-XTVDV(R)-60(-NA)

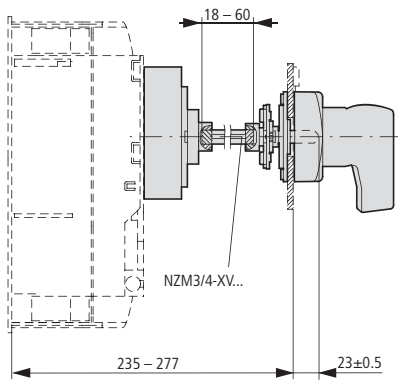

NZM3-XTVDV(R)-0(-NA)

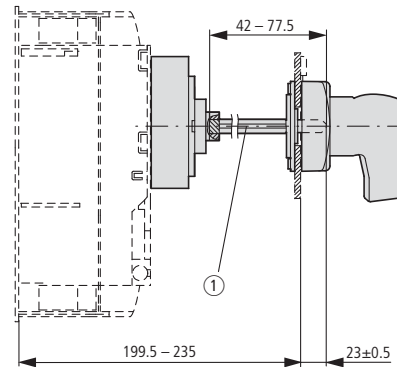

① Special tip

Minimum distance of door coupling rotary handle from door pivot point

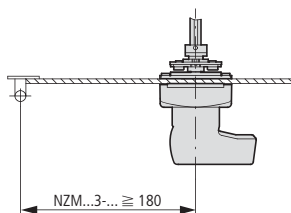

17/216 Circuit-breakers, switch-disconnectors

Construction size 3: accessories

NZM3-XS..., NZM3

Main switch assembly kit for side wall installation

NZM3-XS(R)-L

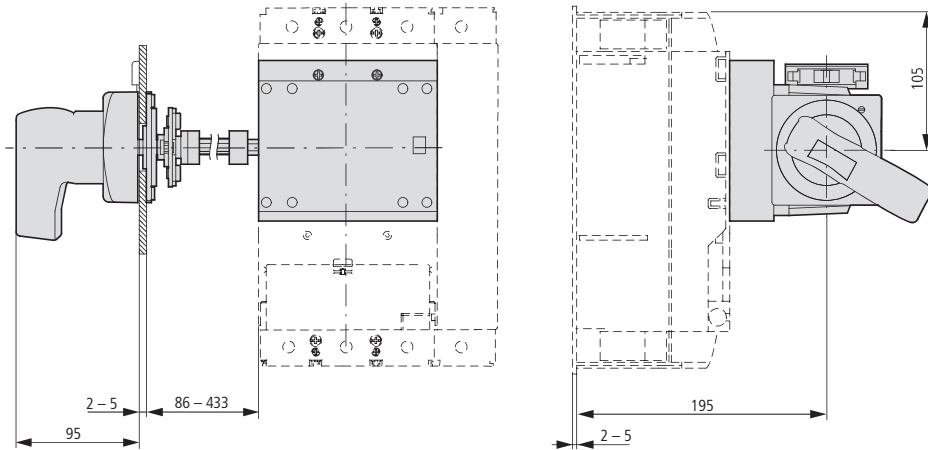

NZM3-XS(R)-R

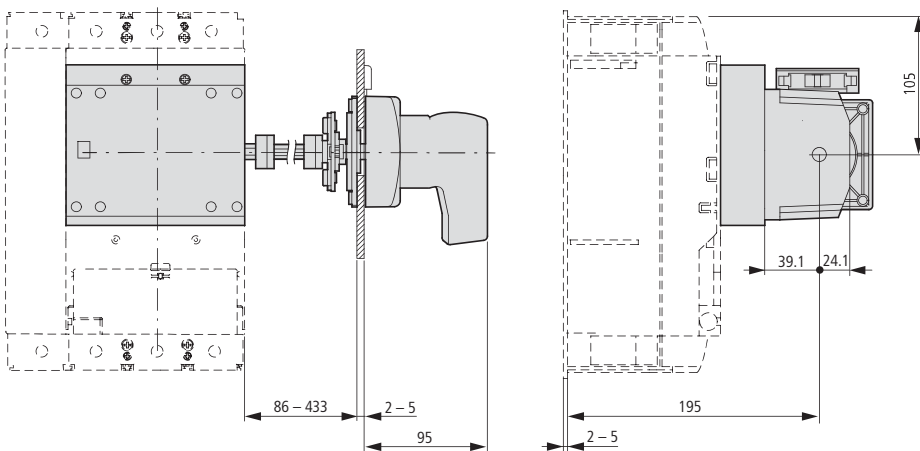

Side-mounted handle

NZM3... XSH...

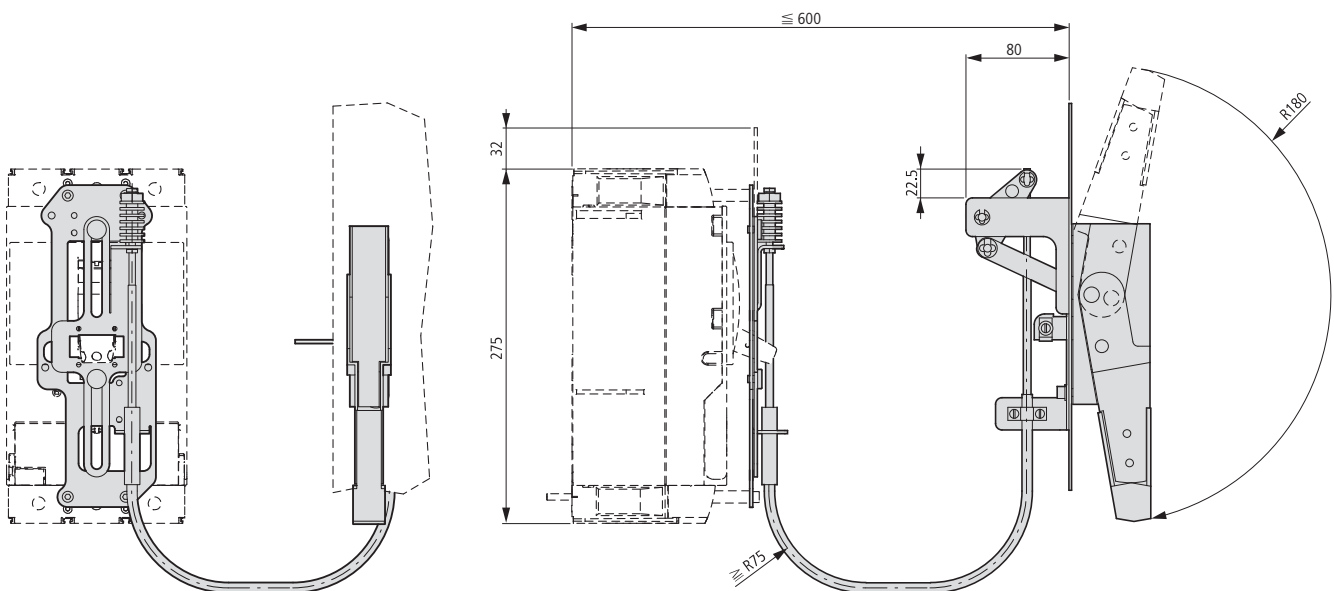

Mechanical interlock

NZM3-XMV + NZM3-XDV(R)

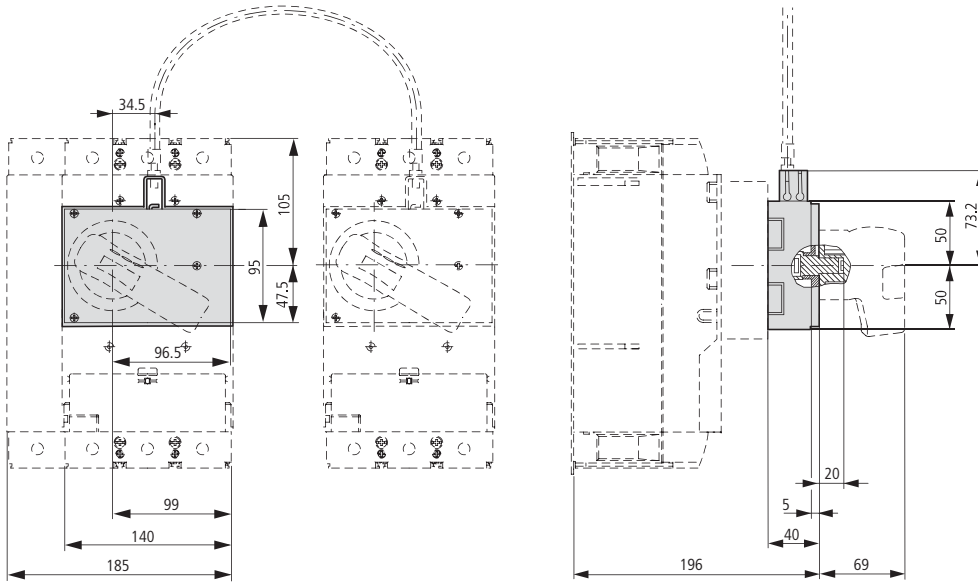

NZM3-XMV + NZM3-XTVD(V)(R)

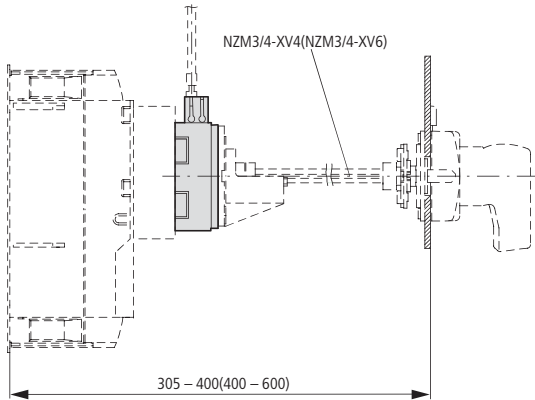

NZM3-XMV + NZM3-XTVD(V)(R)-60

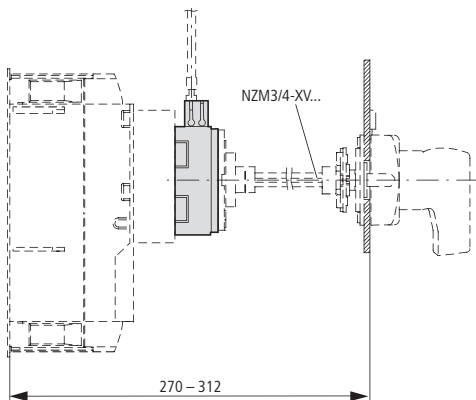

NZM3-XMV + NZM3-XTVD(V)(R)-0

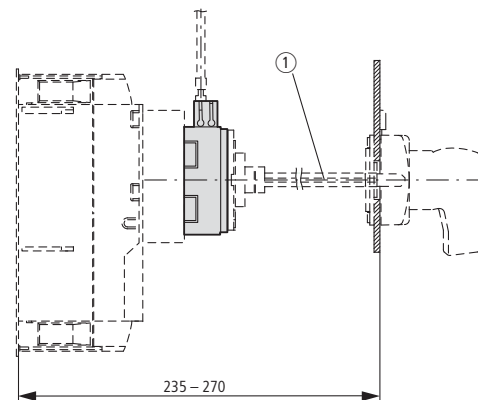

① Special tip



17/218 Circuit-breakers, switch-disconnectors

Construction size 3: accessories

NZM3-XMV, NZM3-XTVD..., NZM3-XDV

Paralleling mechanism

PN3-XPA

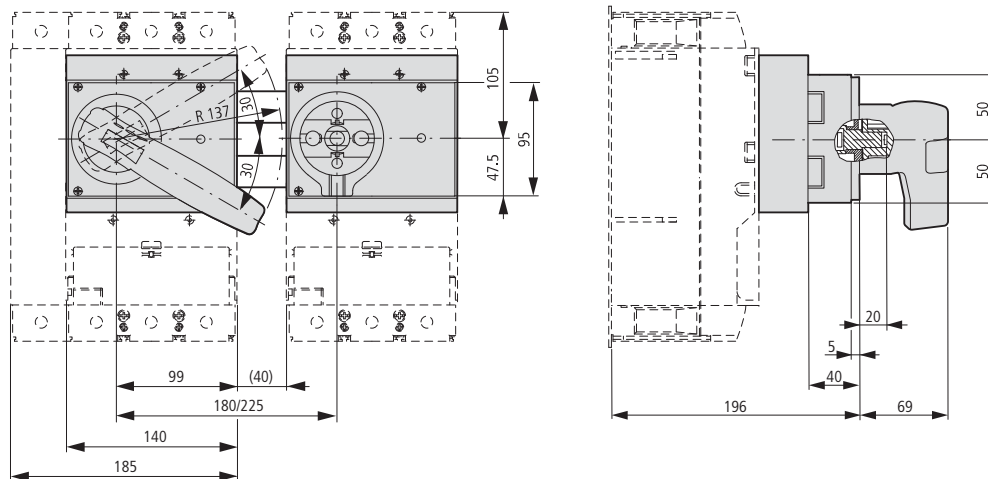

PN3-XPA

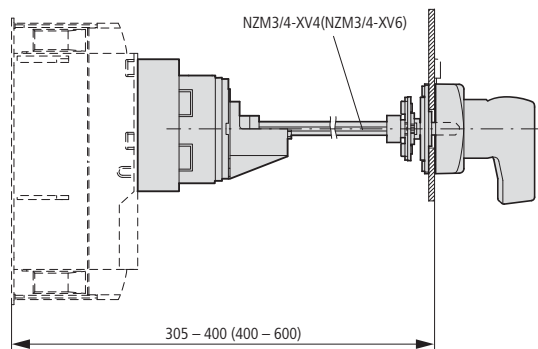

Insulated enclosures

NZM3-XCI48-TD

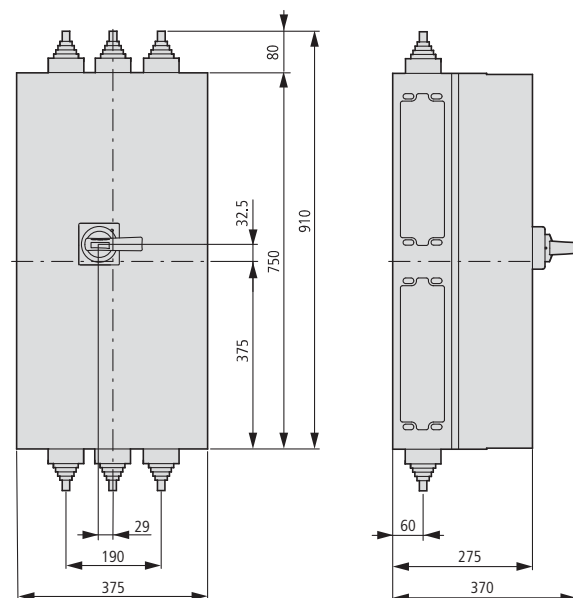

Component adapter

NZM3-XAD550

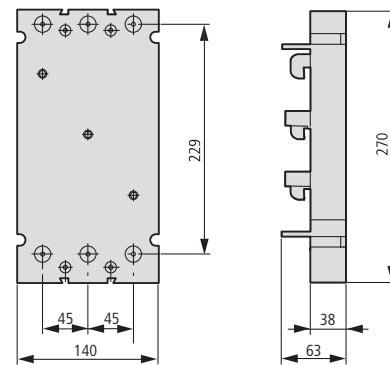

Remote operators

NZM3-XR...

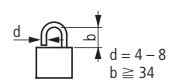
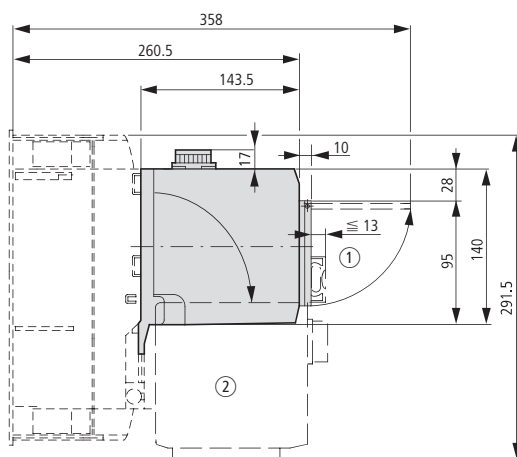
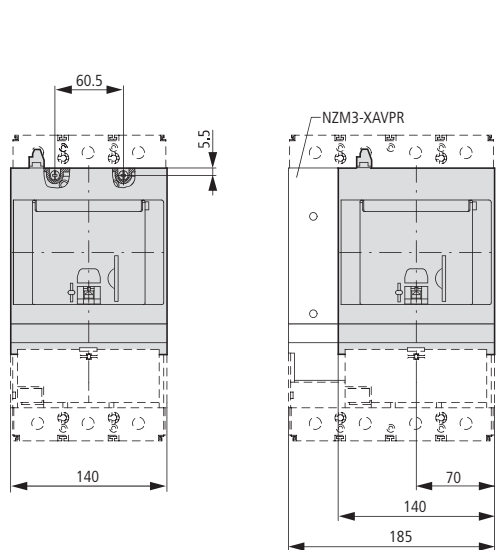

- ① Up to 3 padlocks
- ② Remote operator folded

Withdrawable unit with auxiliary plug-in adapter

NZM3-...-SVE

N3...-SVE

NZM3-XSVS

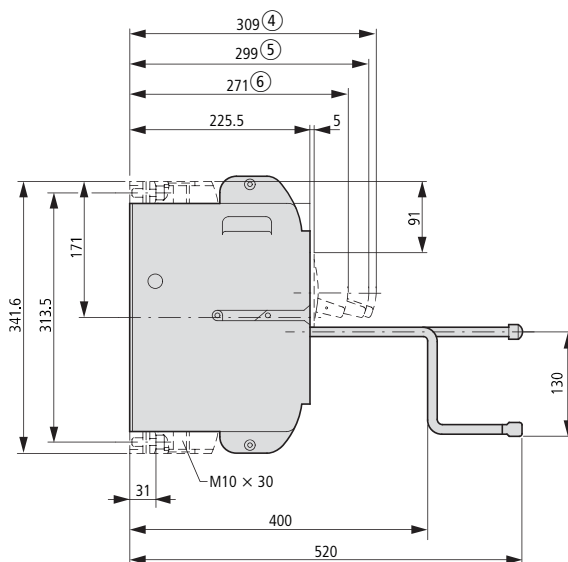
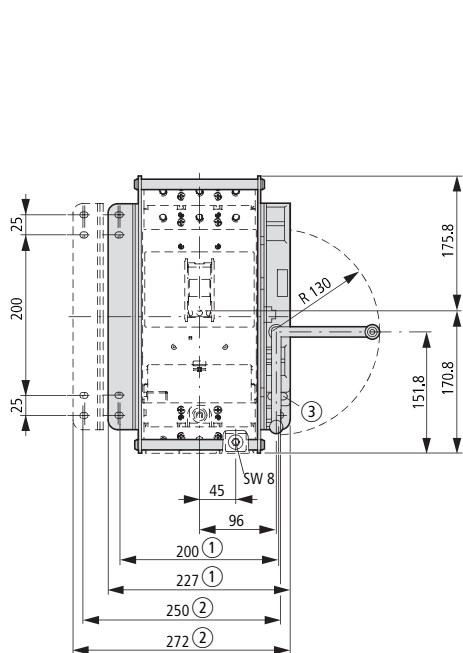

- ① 3 pole
- ② 4 pole

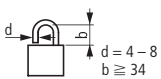

- ③ Up to 3 padlocks

- ④ Disconnected
- ⑤ Test
- ⑥ Connected



Covers

NZM4(-4)-XKSA

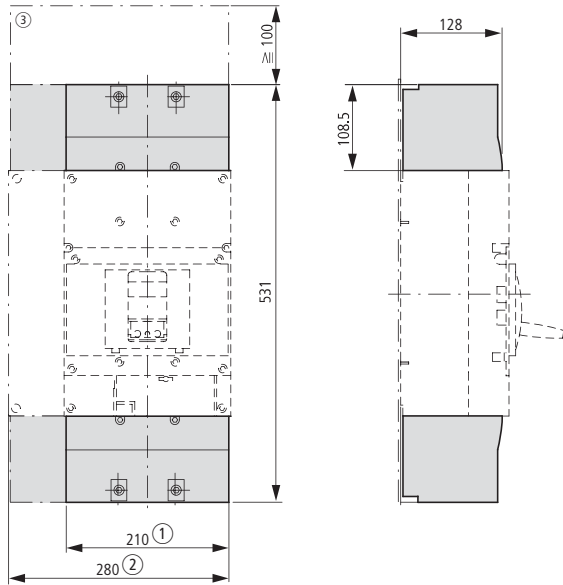

Tunnel terminal

NZM4-4-XKA

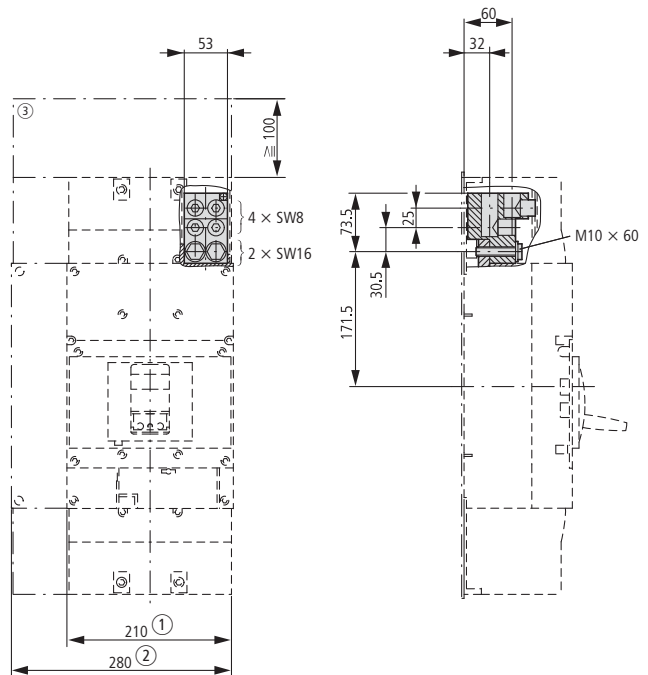

- ① 3 pole
- ② 4 pole
- ③ Clearance from conductive parts ≥ 100 mm up to 690 V; ≥ 200 mm up to 1000 V

Screw terminals

Module plate

Flat cable terminal

1-hole

NZM4(-4)-XKB

NZM4(-4)-XKM1

2-hole

NZM4(-4)-XKM2

Part no.	a	b
NZM4(-4)-XKM1	36	47
NZM4(-4)-XKM2	32	40
NZM4(-4)-XKB	—	47

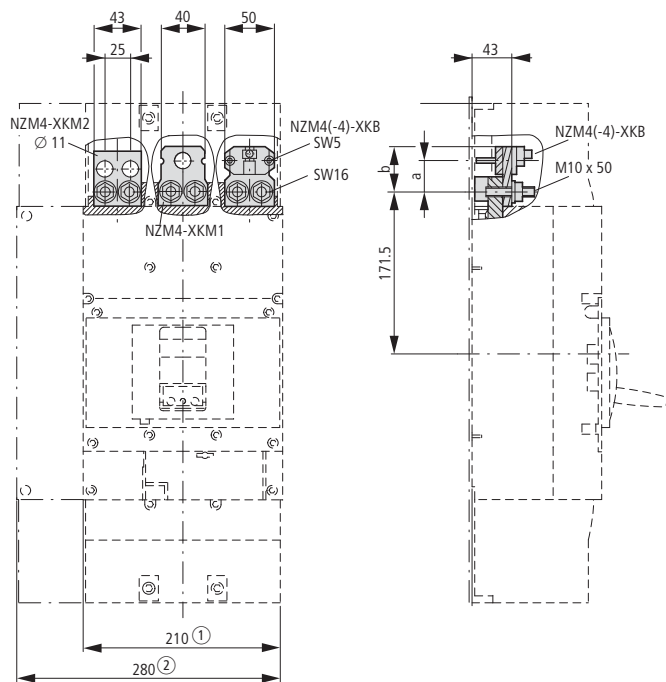

- ① 3 pole
- ② 4 pole
- ③ Clearance from conductive parts ≥ 100 mm up to 690 V; ≥ 200 mm up to 1000 V



17/222 Circuit-breakers, switch-disconnectors

Construction size 4: accessories

NZM4...-XKM, XKV

Module plate

2 hole, vertical

NZM4(-4)-XKM2S...

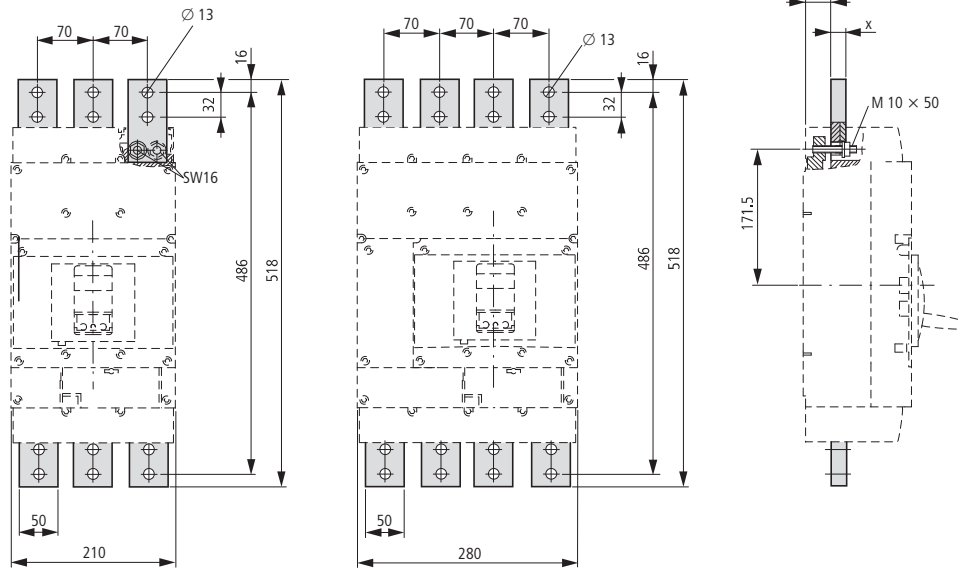

Part no.	x
NZM4(-4)-XKM2S-1250	12
NZM4(-4)-XKM2S-1600	20

Connection width extension

NZM4-XKV95

NZM4-XKV110

Insulation plate

NZM4-XISP

Phase isolators

NZM4-XKP

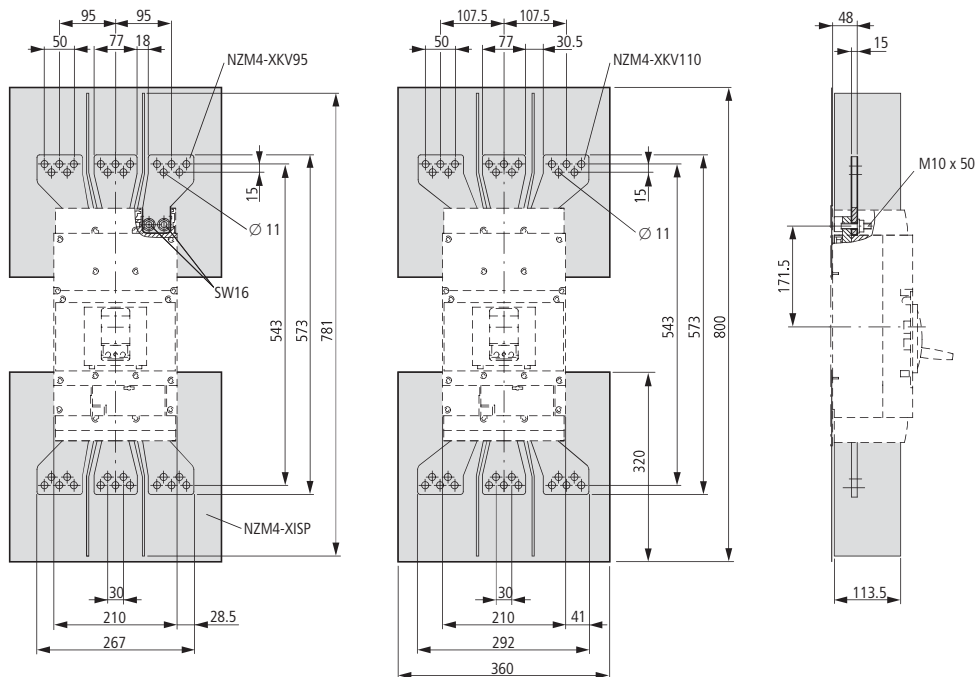

NZM4-4-XKV95

NZM4-4-XKV120

NZM4-4-XISP

NZM4-4-XKP

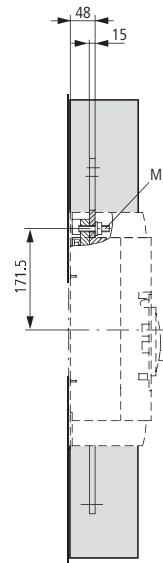
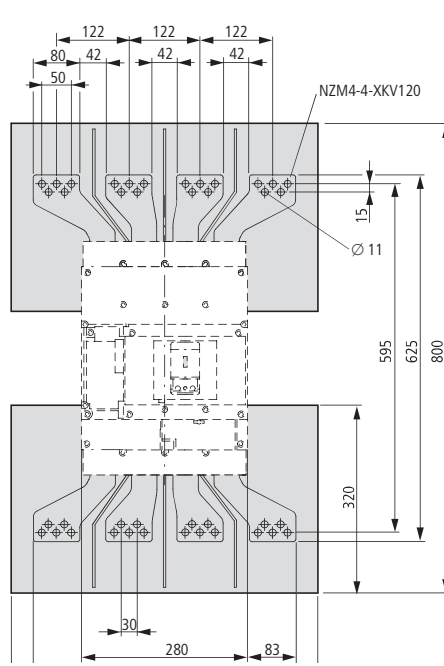
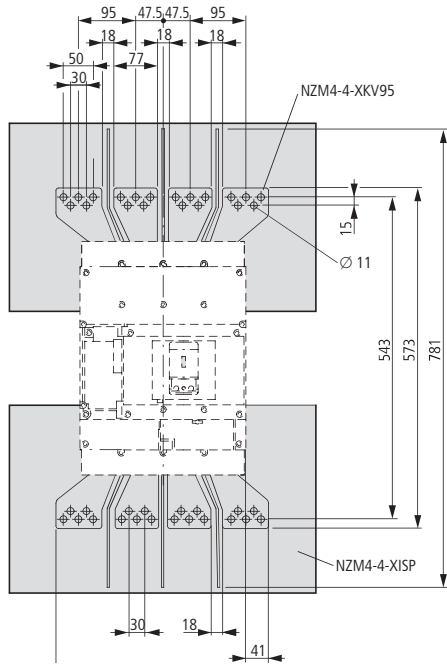

Connection width extension

NZM4-XKV95-2KB

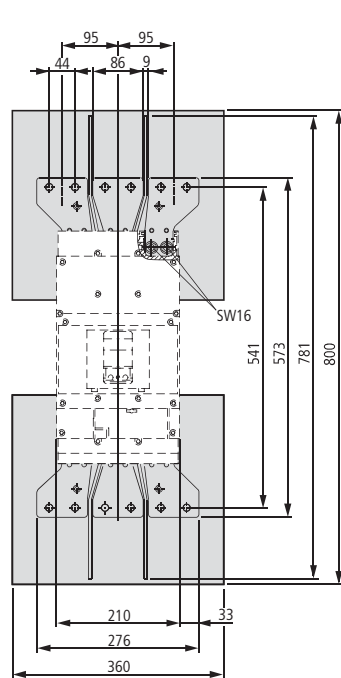

Cover, large

NZM4-XKSAV

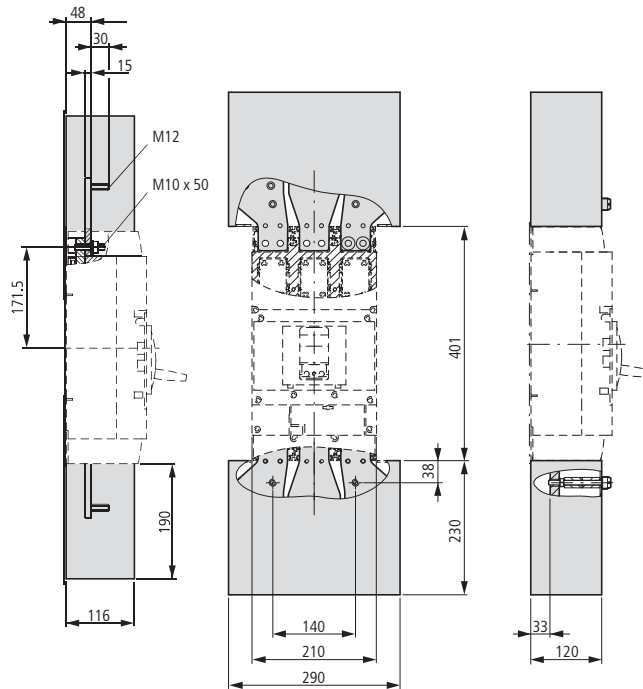

17/224 Circuit-breakers, switch-disconnectors

Construction size 4: accessories

NZM4(-4)-XKP, NZM4(-4)-XKR

Rear terminal bolts

NZM4(-4)-XKR

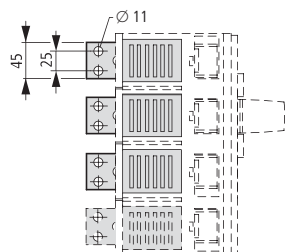
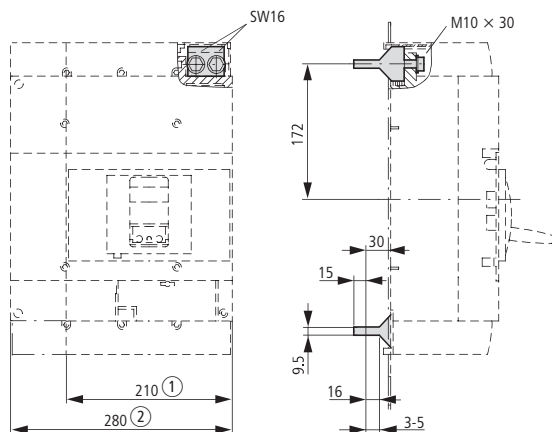

Fitting on mounting plate

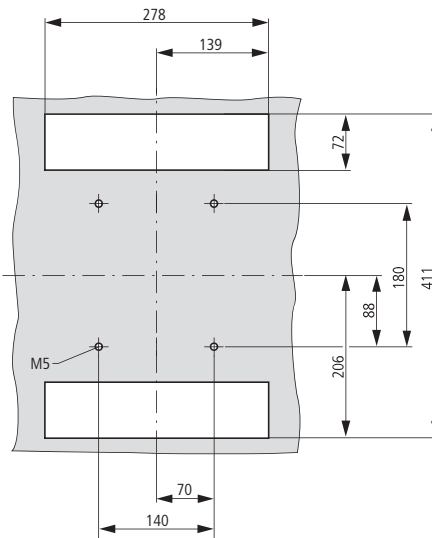

Rear connection possible also rotated by 90°.

- ① 3 pole
- ② 4 pole

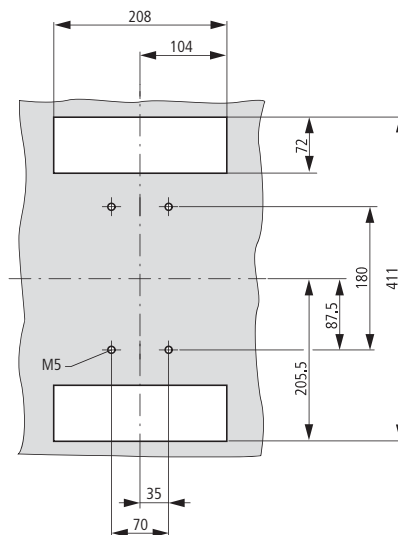

Phase isolators

NZM4(-4)-XKP

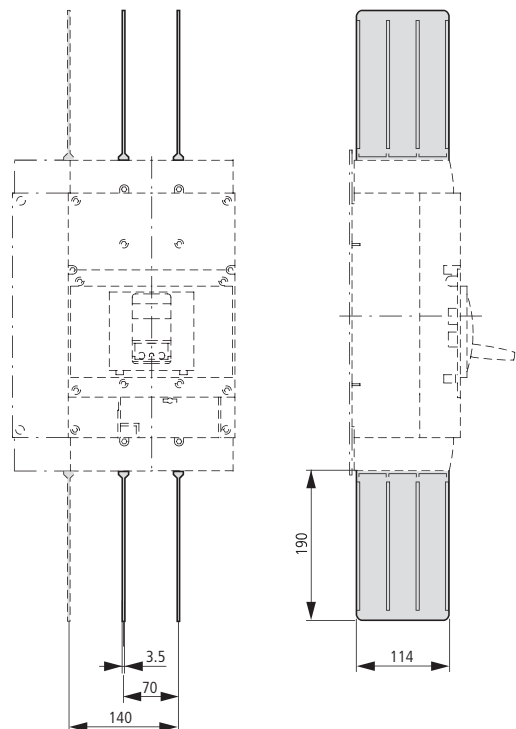

Jumper kit

NZM4-4-XKV2P

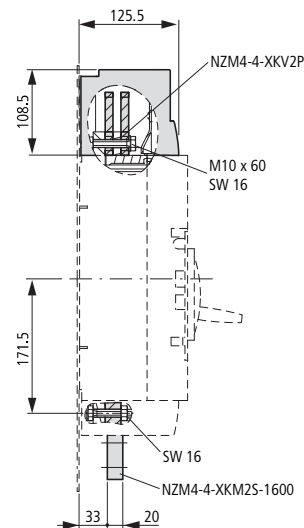
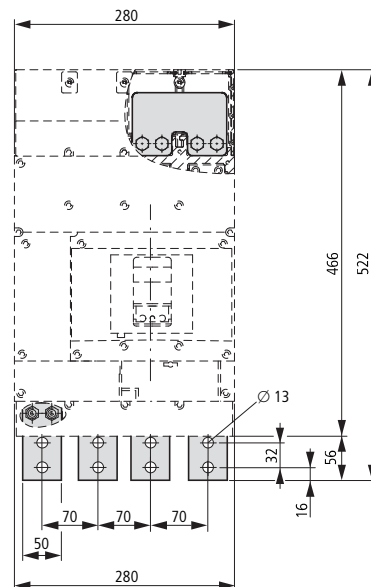

Jumper kit

NZM4-4-XKV2P-1400

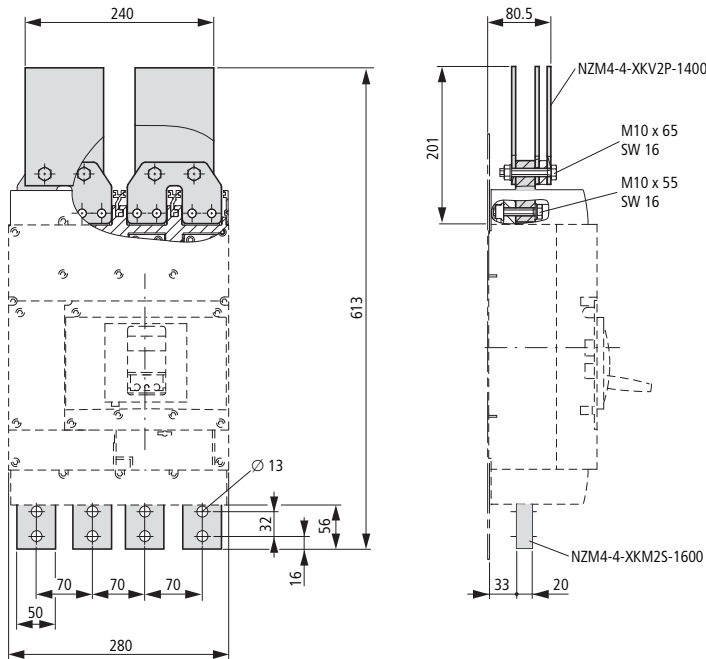

Adapter kit

NZM4-XAS14-1250

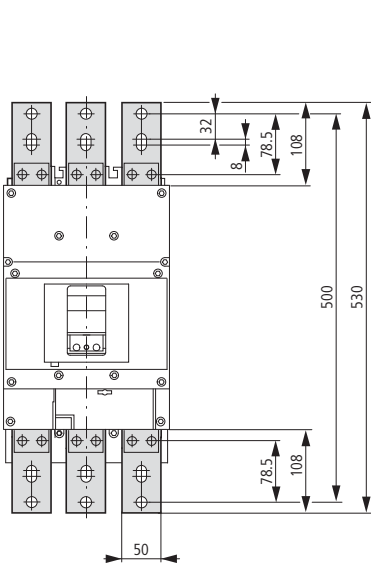

NZM4-XAS14-1600

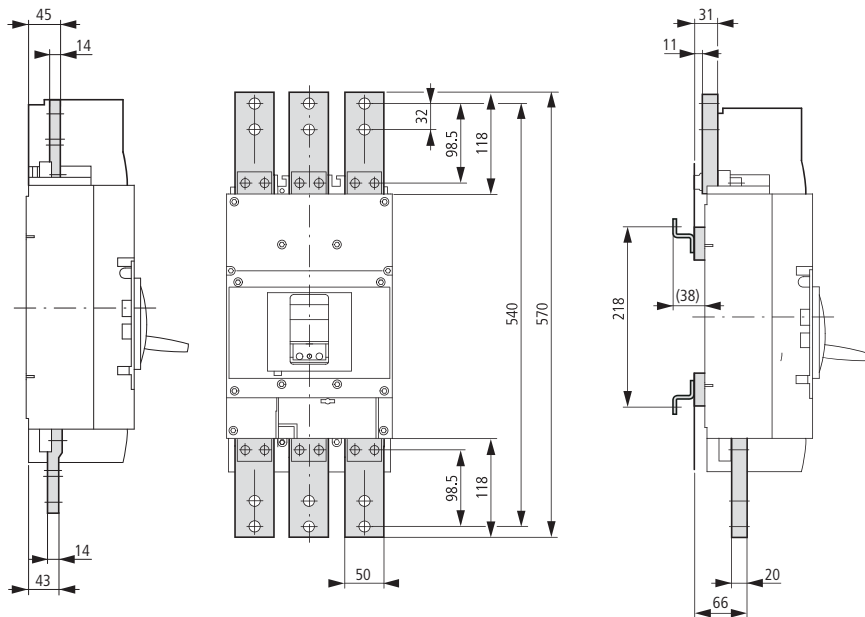

Drilling template NZM12-1000 (1250) conversion to NZM4

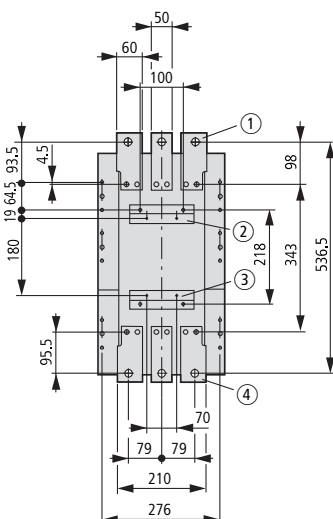

- ① Module plate NZM4-XAS12-1000(1250)
- ② Holes for mounting bracket NZM4-XAS12(M5)
- ③ Mounting bracket NZM4-XAS12
- ④ Mounting rail NZM12



17/226 Dimensions

Construction size 4: NZM12 replacement

NZM12, NZM4-XAS...

Replacement of NZM12-1000(1250) with NZM4 with module plate, fixed mounting on mounting plate

NZM4-XAS12-1000(1250)

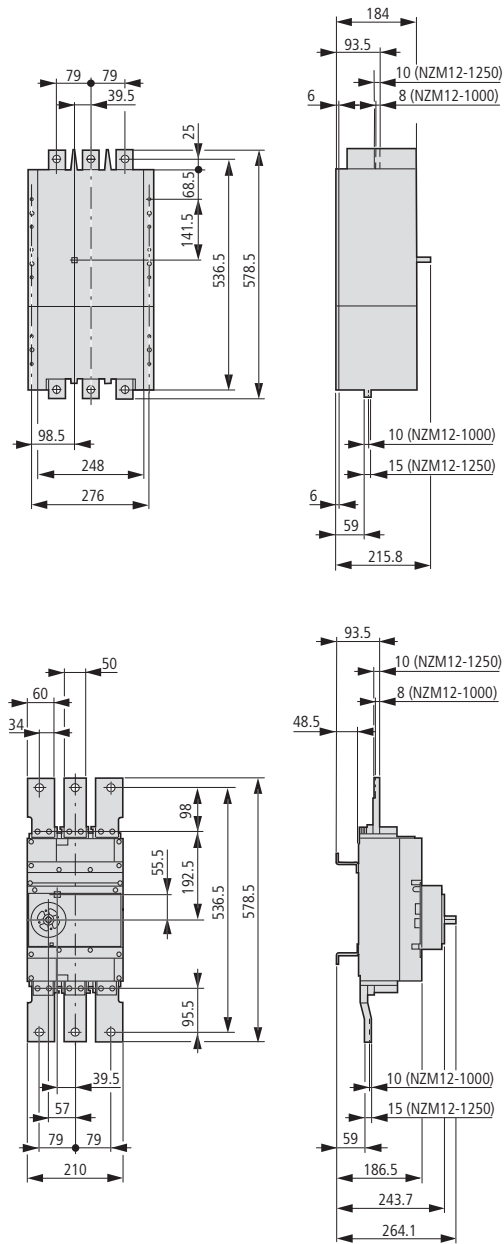

Replacement of NZM12-1600 with NZM4 with module plate, fixed mounting on mounting plate

NZM4-XAS12-1600

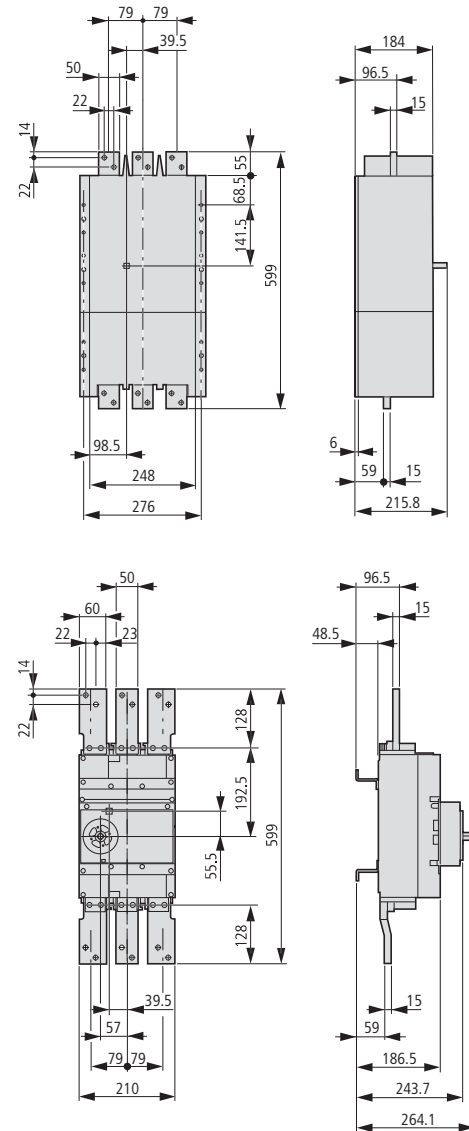

Replacement of N12-1000(1250) with N4 with module plate, fixed mounting on mounting plate
N4-XAS12-1000(1250)

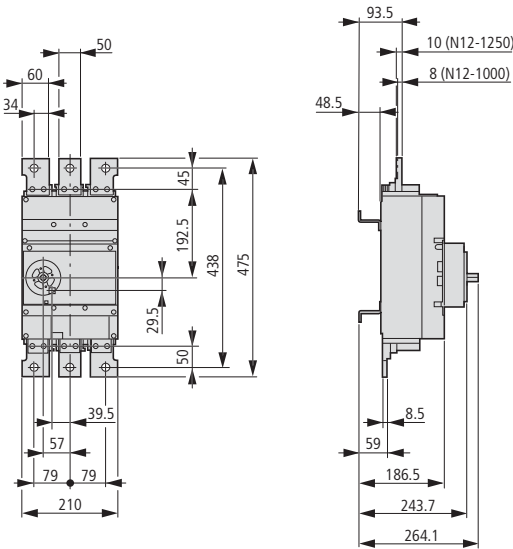
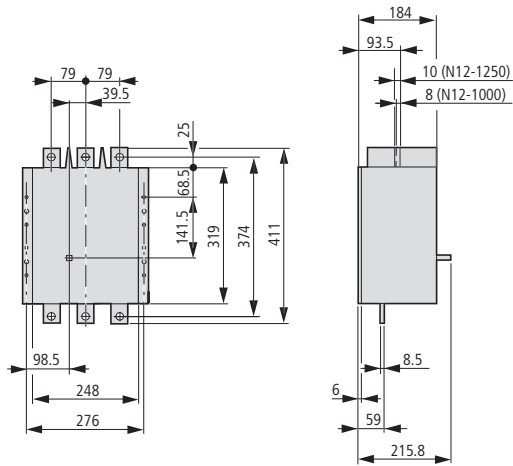

Replacement of N12-1600 with N4 with module plate, fixed mounting on mounting plate
N4-XAS12-1600

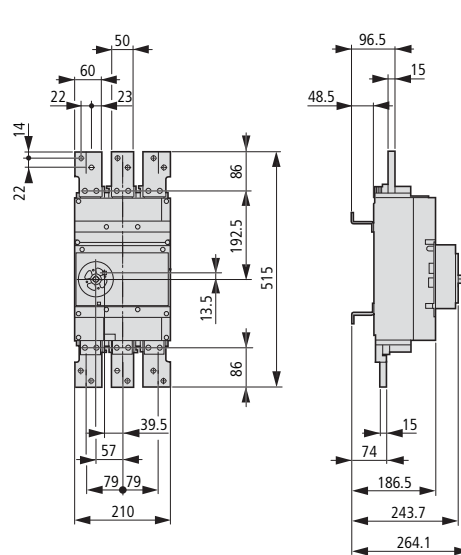
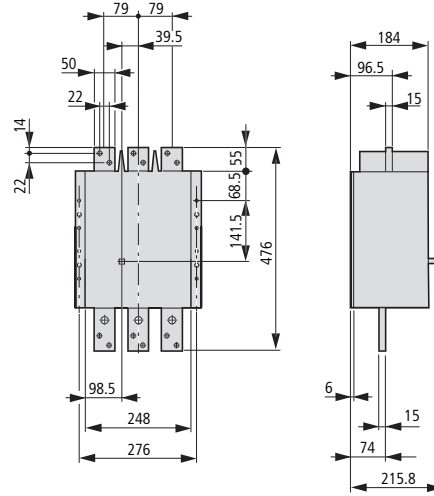

17/228 Circuit-breakers, switch-disconnectors

Construction size 4: accessories

NZM4-XDV..., NZM4-XTVD...

Rotary handle on circuit-breaker

NZM4-XDV(R)

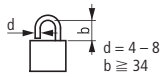
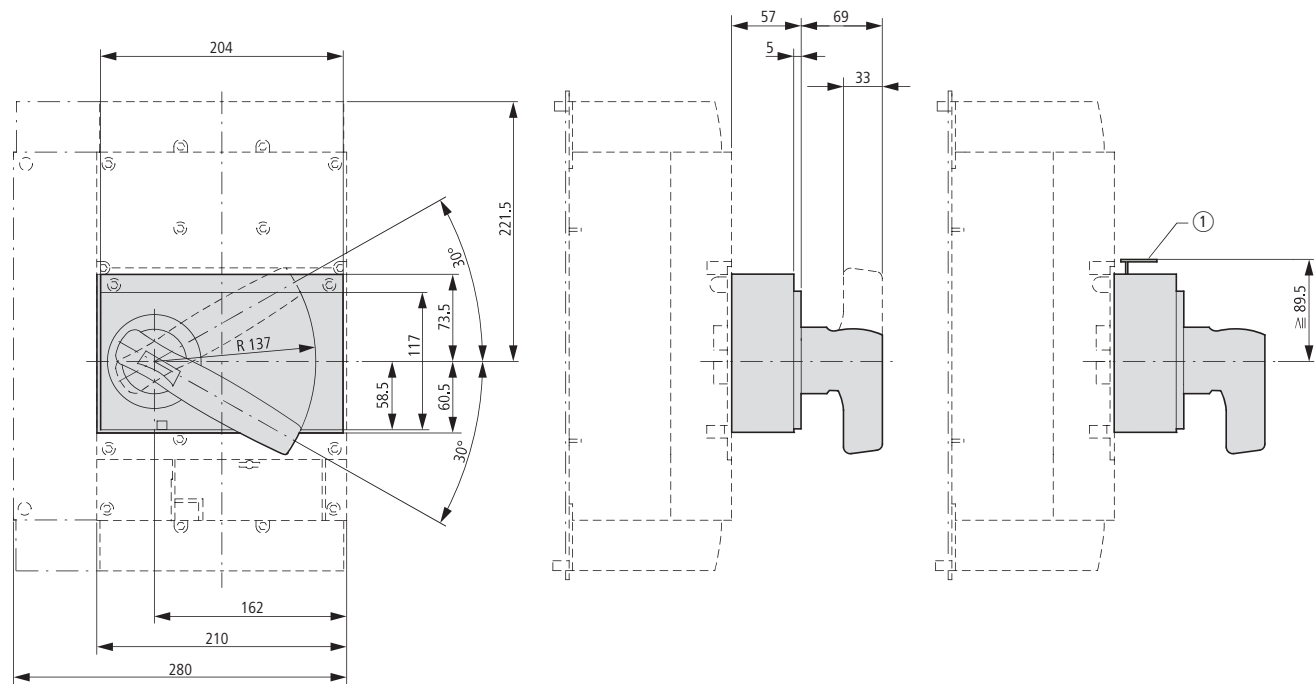

① Up to 3 padlocks

Door coupling rotary handles

NZM4-XTVD(V)(R)...

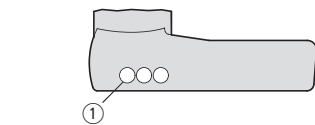
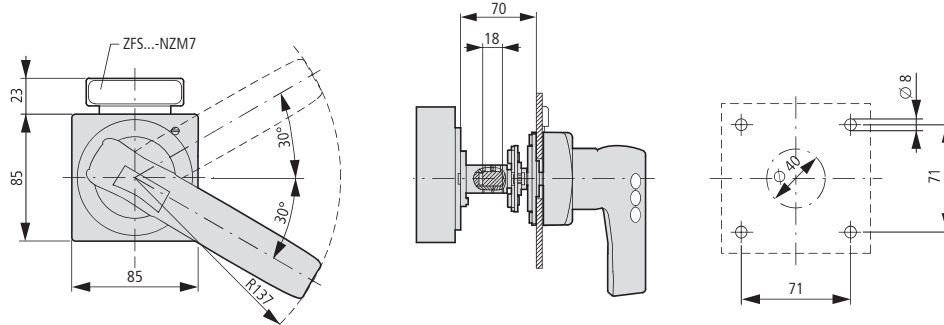

① Up to 3 padlocks

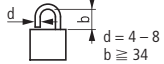

Door coupling rotary handle with extension shaft

NZM4-XTVD(V)(R)(-NA)
NZM3/4-XV4(6)

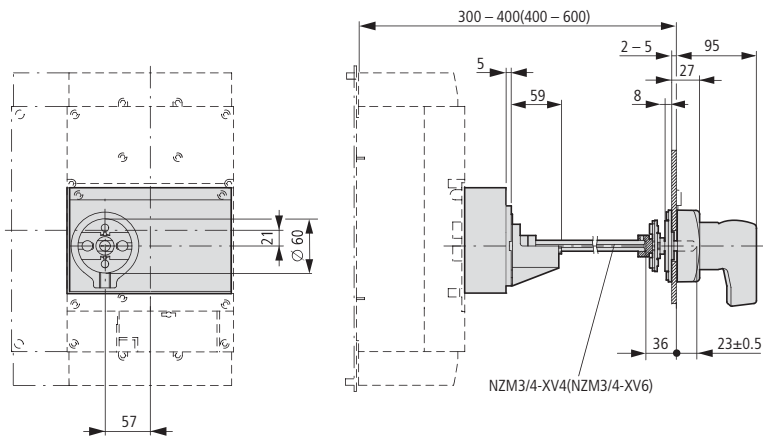

NZM4-XTVD(V)(R)-60(-NA)

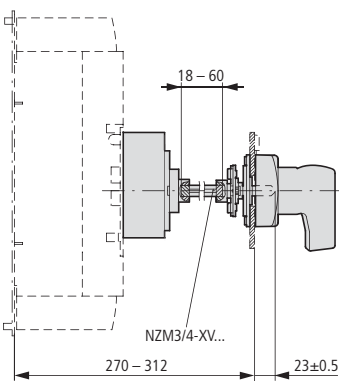

NZM4-XTVD(V)(R)-0(-NA)

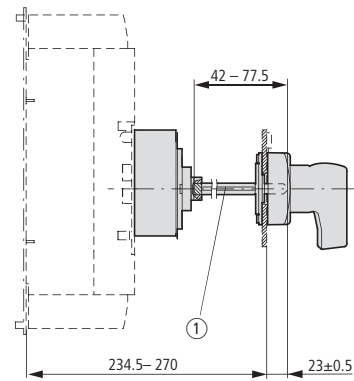

① Special tip

Minimum distance of door coupling rotary handle from door pivot point

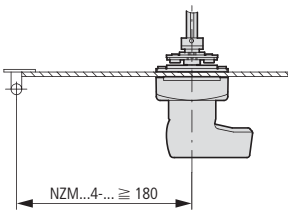

Main switch assembly kit for side wall installation

NZM4-XS(R)-L
NZM4-XS(R)-R

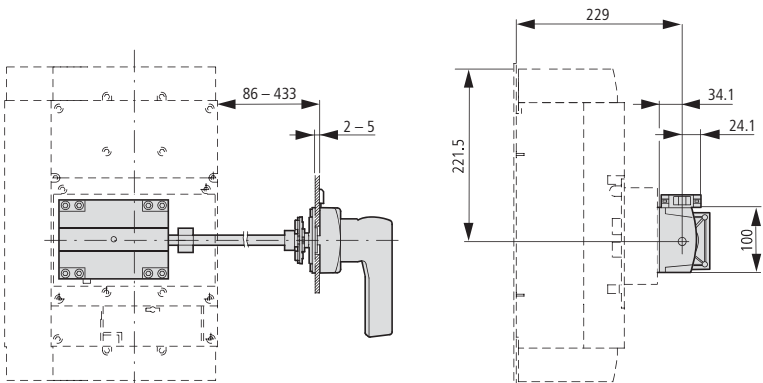

17/230 Circuit-breakers, switch-disconnectors

Construction size 4: accessories

NZM4-XBR, NZM4-XMV, NZM4-X...

Insulating surround

NZM4-XBR

① Mounting aperture

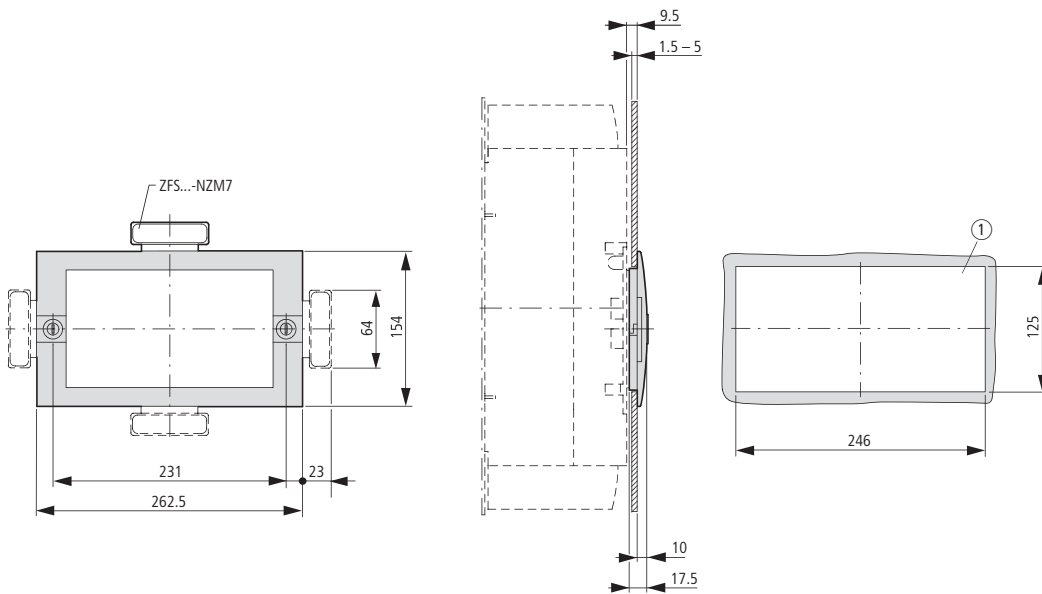

NZM4-XBRS

① Mounting aperture

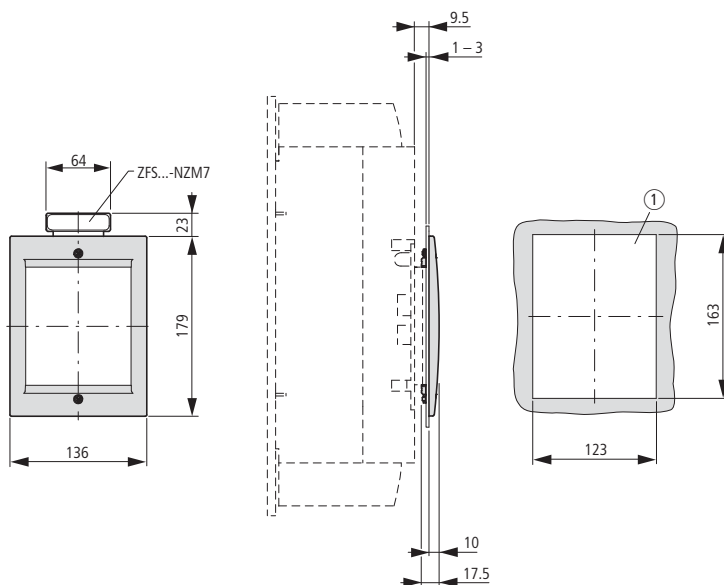

Mechanical interlock

NZM4-XMV + NZM4-XDV(R)

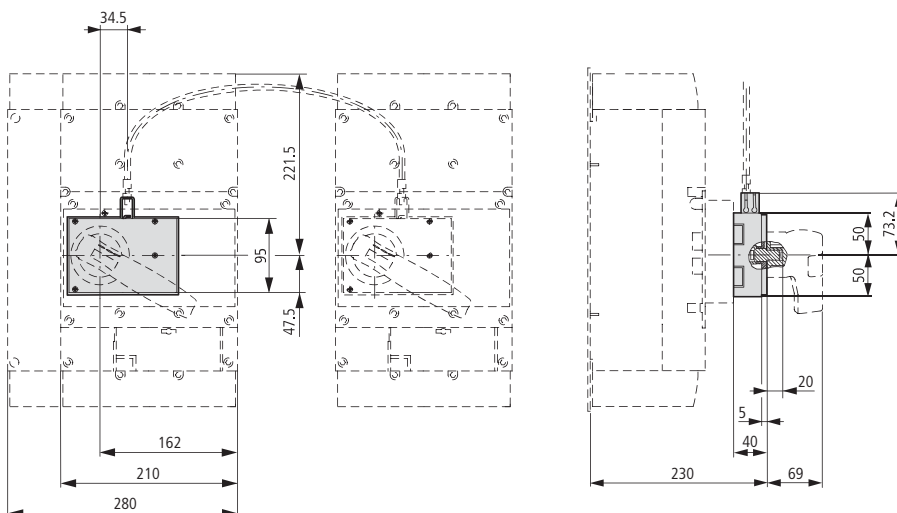

Mechanical interlock

NZM4-XMV + NZM4-XTVD(V)(R)

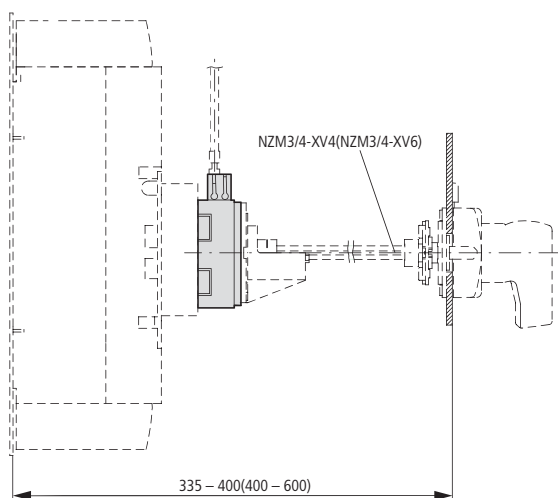

NZM4-XMV + NZM4-XTVD(V)(R)-60

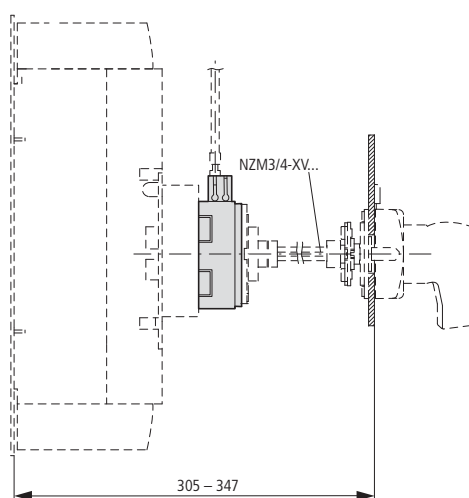

NZM4-XMV + NZM4-XTVD(V)(R)-0

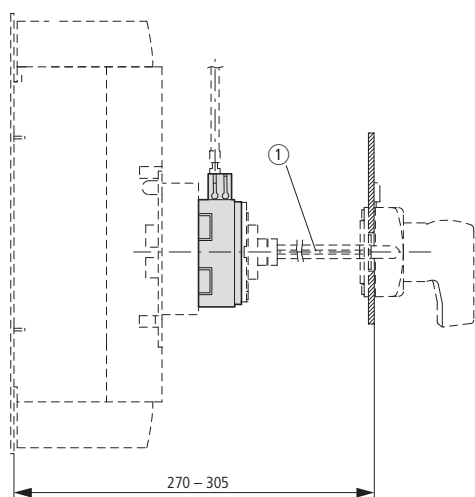

① Special tip



17/232 Circuit-breakers, switch-disconnectors

Construction size 4: accessories

NZM4...-XAV

Remote operators

NZM4-XR...

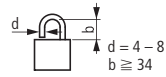
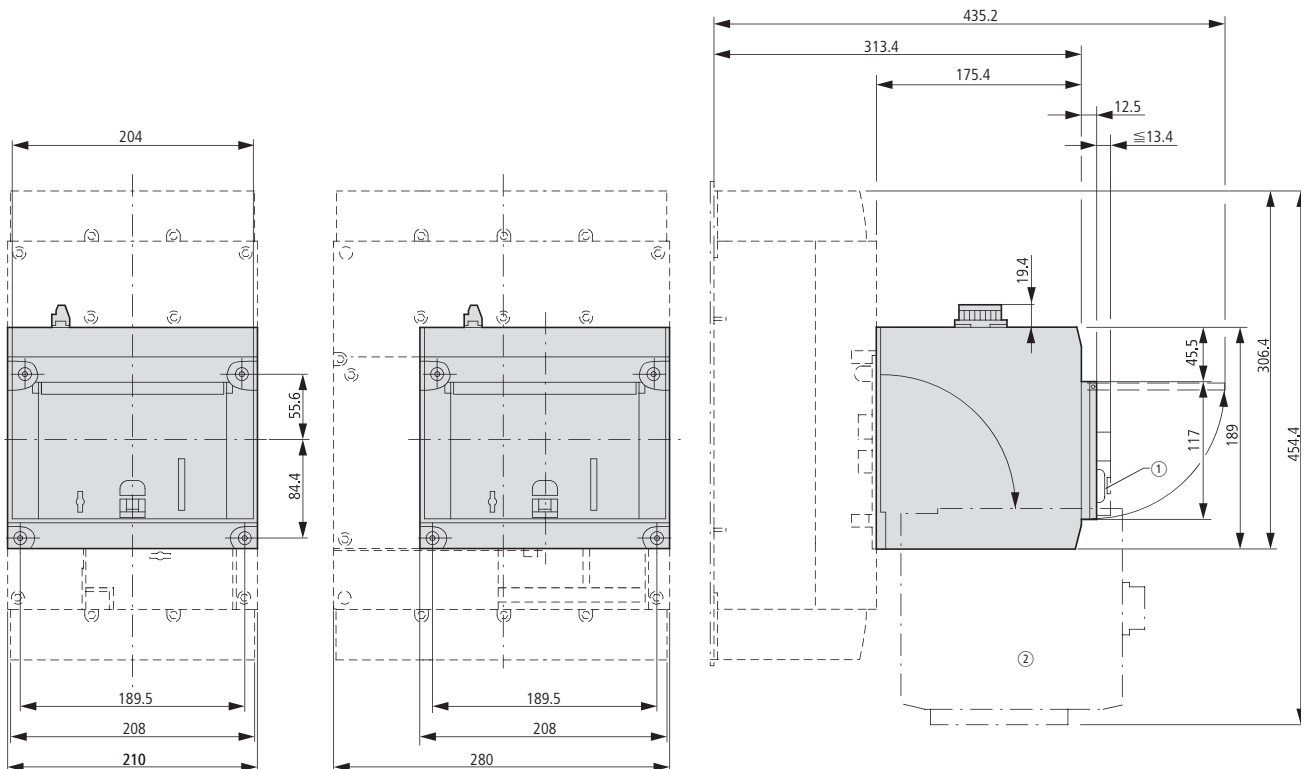

- ① Up to 3 padlocks
- ② Remote operator folded

Withdrawable unit

+NZM4-4-XAV

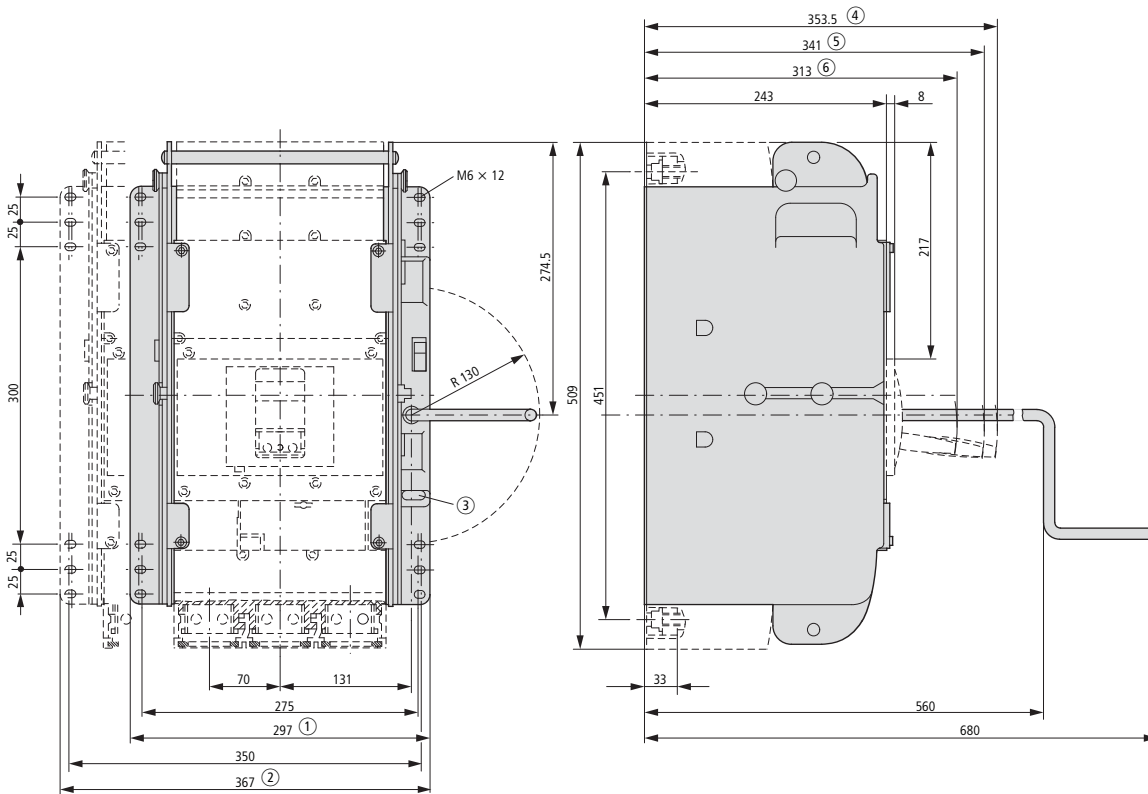

- ① 3 pole
- ② 4 pole

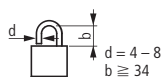

- ③ Up to 3 padlocks

- ④ Disconnected
- ⑤ Test
- ⑥ Connected

Measuring and communication module

NZM2 (3)...XMC-S0(MB)

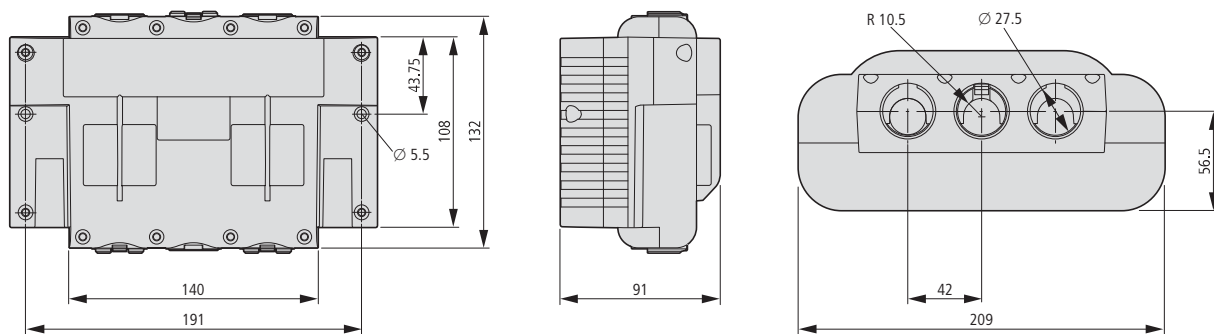

NZM2 (3)(-4)...XMC-S0(MB)

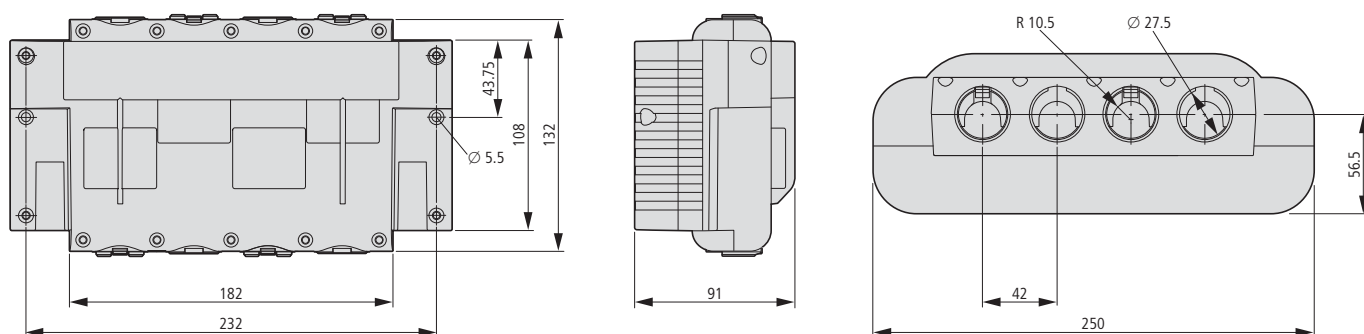

Communication interface for SmartWire-Darwin

NZM-XSWD-704

